

Grove RT890E

Product Guide



80 t



43,2 m



10,0 - 17,0 m



72,0 m



Rough Terrain Crane • Geländekran
Grue Tout-Terrain • Grúa Todo Terreno
Autogru Fuoristrada • Grua RT
Кран для использования на пересеченной местности

Features • Besonderheiten • Caractéristiques • Carasterísticas Caratteristiche • Carasterísticas • Особенности



- **Boom** - The RT890E is equipped with a 11,4 m - 43,2 m five-section, full power boom. The Grove MEGAFORM™ boom shape eliminates weight and increases capacity compared to conventional shapes.
- **Ausleger** - Der RT890E ist mit einem fünfteiligen 11,4 m - 43,2 m langen vollhydraulischen Ausleger ausgestattet. Durch das spezielle Design des Grove MEGAFORM™-Auslegers kann im Vergleich zu konventionellen Auslegern Gewicht eingespart und die Leistung gesteigert werden.
- **Flèche** - Le RT890E est équipé d'une flèche entièrement hydraulique à cinq éléments de 11,4 - 43,2 m. La forme de la flèche Grove MEGAFORM™ réduit le poids et augmente la capacité par rapport aux formes conventionnelles.
- **Pluma** - La RT890E está provista de una pluma totalmente motorizada de cinco secciones, de 11,4 a 43,2 m. La pluma con forma Grove MEGAFORM™ reduce peso y aumenta la capacidad en comparación con las formas convencionales.
- **Braccio** - La RT890E è dotata di un braccio completamente motorizzato da 11,4 m - 43,2 m, cinque sezioni. La sezione del braccio Grove MEGAFORM™ riduce il peso e aumenta la capacità rispetto alle configurazioni convenzionali.
- **Lança** - A RT890E está equipada com uma lança dividida em cinco secções, totalmente extensível entre 11,4 m e 43,2 m. A forma MEGAFORM™ das lanças Grove proporciona uma redução de peso e um aumento de capacidade quando comparado com as formas tradicionais.
- **Удлинение стрелы** - Модель RT890E оборудована пятисекционной стрелой с полной мощностью длиной 11,4 м - 43,2 м. The Grove Модель MEGAFORM™ boom снижает вес и увеличивает грузоподъемность по сравнению со стандартными моделями.



- **Removable counterweight** - Counterweight and auxiliary hoist is hydraulically removed/installed for easier hauling from job to job.
- **Abnehmbares Gegengewicht** - Das Gegengewicht und der Hilfsausleger können zur leichteren Beförderung von Baustelle zu Baustelle hydraulisch abgenommen/ installiert werden.
- **Contrepoids amovible** - Installation et dépose hydrauliques du contrepoids et du treuil auxiliaire pour faciliter le transport d'un chantier à l'autre.
- **Contrapeso extraíble** - Contrapeso y cabrestante auxiliar de montaje/desmontaje hidráulico para un arrastre más fácil de trabajo a trabajo.
- **Contrappeso rimovibile** - Contrappeso e argano ausiliario che si installa/rimuove con comando idraulico per un facile trasporto da un lavoro ad un'altro.
- **Contrapeso amovível** - Contrapeso e guincho auxiliar movido hidráulicamente e instalado para elevação mais fácil de tarefa em tarefa.
- **Съемный противовес** - Гидравлическая система снятия и установки противовеса и вспомогательной лебедки для более простого перемещения между рабочими площадками.

- **Full vision cab** - New full-vision cab, all-steel fabricated with acoustic lining and tinted safety glass throughout. For improved operator comfort and visibility of the boom load, the cab can be tilted up to 20°.
- **Kabine mit Rundumsicht** - Neue Fahrerkabine mit Rundumsicht, komplett aus Stahl mit Lärmschutzisolierung und mit rundum getöntem Sicherheitsglas. Für erhöhten Bedienerkomfort und eine bessere Sicht auf die Last am Haken kann das Fahrerhaus um bis zu 20° geneigt werden.
- **Cabine panoramique** - Nouvelle cabine panoramique tout acier, fabriquée avec une isolation sonore et un vitrage teinté de sécurité sur tout le pourtour. Pour améliorer le confort de l'opérateur et sa visibilité sur la charge de la flèche, la cabine s'incline jusqu'à 20°.
- **Cabina de visión panorámica** - Nueva cabina de visión panorámica, fabricada totalmente en acero con revestimiento acústico y cristal de seguridad completamente tintado. Para mejor confort del operario y mejor visibilidad de la carga de pluma, la cabina puede inclinarse hasta 20°.
- **Cabina "Full Vision"** - Nuova cabina ad ampia visibilità, completamente realizzata in acciaio con rivestimento acustico e vetri di sicurezza colorati. Per migliorare il comfort dell'operatore e la visibilità del carico sul braccio, la cabina è inclinabile fino a 20°.
- **Cabina panorâmica** - Nova cabina panorâmica, que permite uma visibilidade completa, fabricada integralmente em aço com isolamento acústico e vidro de segurança colorido. Para mais conforto e visibilidade do operador da carga da lança, a cabine pode ser inclinada a 20°.
- **Кабина с круговым обзором** - Новая цельносталевая кабина с круговым обзором, со звукоизоляционной обивкой и затемненным небьющимся стеклом по всему периметру. Для повышения комфорта оператора и улучшения видимости груза, кабину можно наклонить до 20°.



Features • Besonderheiten • Caractéristiques • Carasterísticas Caratteristiche • Carasterísticas • Особенности

- **Inverted outrigger jacks:** allows to protect the cylinder rod from sand, dust, oils and various elements you can find on a jobsite and increases seal life. The outriggers can be spread in 3 different positions: fully retracted, 50 % and 100 % open.
- **innen liegende Abstützzylinder:** schützt die Zylinderstange vor Sand, Staub, Öl und verschiedenen anderen Einflüssen auf der Baustelle. Die Abstützträger können in 3 Stellungen fixiert werden: Voll eingefahren, 50 % und 100 % ausgefahren.
- **Système de calage inversé :** permet de protéger la tige de vérin du sable, de la poussière, de la graisse et de tout autre élément courant sur un site de chantier. Le système de calage peut être placé dans 3 positions : entièrement rentré, 50 % et 100 %.
- **Estabilizadores invertidos:** permite proteger el vástago del cilindro, de la arena, el polvo, aceites y diversos elementos que se pueden encontrar en el lugar de trabajo. Los estabilizadores se pueden fijar en 3 posiciones diferentes: Totalmente plegados, 50% y 100%.
- **Stabilizzatori a steli rovesciati:** consentono di proteggere lo stelo del cilindro dagli urti oltre che dalla sabbia, polvere, olio e vari elementi tipici dei cantieri. Gli stabilizzatori possono essere estesi in 3 configurazioni diverse: Completamente retratti, 50% e 100%.
- **Estabilizadores invertidos:** permite proteger a haste do cilindro da areia, do pó, dos óleos e dos vários elementos que se podem encontrar num local de trabalho. Os estabilizadores podem ser fixos em 3 posições diferentes: totalmente fechados, abertos a 50% e abertos a 100%.
- **Перевернутые цилиндры опор:** способствуют защите штока цилиндра от попадания песка, пыли и прочих веществ, имеющих на рабочем месте. Выносные опоры можно устанавливать в 3 различных положениях: выдвинув полностью, на 50% или 100%.

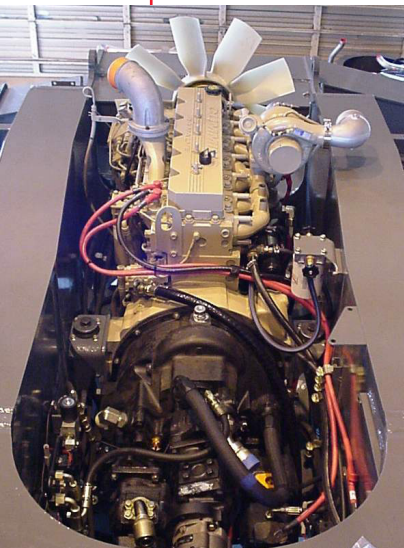
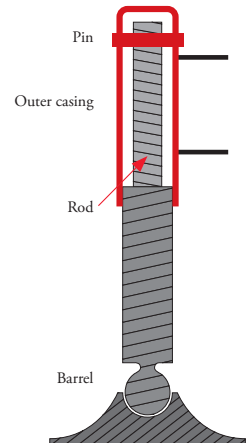

- **Tier IV / Euromot 3B compliant engine:** cranes are equipped with engines that meet emissions per U.S.E.P.A. Tier IV and E.U. Stage 3B; engines Tier III / Euromot 3A are available for sales outside of European Union and North American countries.
- **Emissionswerte gemäß Tier IV/Euromot 3B:** Die Krane sind mit Motoren ausgerüstet, die die Emissionsvorgaben der Verordnungen U.S.E.P.A. Tier IV bzw. E.U. Stufe 3B erfüllen; Motoren mit Emissionswerten gemäß Tier III bzw. Euromot 3A werden außerhalb Europas und Nordamerikas vertrieben.
- **Moteur conforme à Tier IV / Euromot 3B :** les grues sont équipées de moteurs respectant les exigences en matière d'émissions selon l'U.S.E.P.A. Tier IV et E.U. Phase 3B ; les moteurs Tier III / Euromot 3A sont disponibles à la vente hors de l'Union européenne et des pays d'Amérique du Nord.
- **Motor conforme a los estándares Tier IV / Euromot 3B:** las grúas cuentan con motores que cumplen las normativas de emisiones contaminantes Tier IV de la U.S.E.P.A. y Fase 3B de la U.E.; Se dispone de motores Tier III / Euromot 3A para venta fuera de la Unión Europea y Norteamérica.
- **Motore conforme Tier IV i / Euromot 3B:** le autogru sono equipaggiate con motori conformi alla normativa Tier IV Interim (U.S.A.) / Euromot 3B (C.E.); i motori Tier III / Euromot 3A sono disponibili per vendita al di fuori dell'Unione Europea e dei paesi del Nord America.
- **Motor em conformidade com Tier IV / Euromot 3B:** as gruas estão equipadas com motores que respeitam as emissões de acordo com Tier IV da USEPA e Classe III B da UE; os motores Tier III / Euromot 3A estão disponíveis para venda fora da União Europeia e países da América do Norte.
- **Двигатель типа Tier IV / Euromot 3B, отвечающий применимым экологическим требованиям:** краны оснащены двигателями, удовлетворяющими требованиям по выбросам U.S.E.P.A. Tier IV и E.U. Stage 3B; двигатели типа Tier III / Euromot 3A продаются вне Европейского Союза и стран Северной Америки.

CraneSTAR

EQUIPPED

- **CraneSTAR** is an exclusive and innovative crane asset management system that helps improve your profitability and reduce costs by remotely monitoring critical crane data. Visit www.cranestar.com for more information.
- **CraneSTAR** ist ein exklusives und innovatives Flottenmanagementsystem, das Ihnen hilft, auch außerhalb Ihres Büros wichtige Krandaten abzurufen und somit Ihre Profitabilität zu steigern und Kosten zu reduzieren. Mehr Informationen unter www.cranestar.com.
- **CraneSTAR** est un système exclusif et innovant de gestion de parc de grues qui contribue à améliorer la rentabilité et à réduire les coûts en surveillant à distance les données cruciales des grues. Visitez www.cranestar.com plus de plus amples informations.
- **CraneSTAR** es un sistema exclusivo e innovador de gestión de flotas de grúas que ayuda a mejorar la rentabilidad y reducir los costes controlando a distancia los datos críticos de la grúa. Más información en www.cranestar.com
- **CraneSTAR** è un esclusivo e innovativo sistema di gestione del parco mezzi che aiuta a migliorare la redditività e ridurre i costi attraverso il monitoraggio remoto dei dati critici dell'autogru. Visitate il sito www.cranestar.com per ulteriori informazioni.
- **CraneSTAR** é um sistema exclusivo e inovador de gestão de frotas de gruas que ajuda a melhorar a sua rentabilidade e a reduzir os custos ao monitorizar à distância os dados importantes da grua. Mais informação em www.cranestar.com.
- **CraneSTAR** - это эксклюзивная инновационная система управления ресурсом подъемного крана, которая позволяет увеличить производительность и сократить расходы путем постоянного дистанционного наблюдения за критическими данными подъемного крана. Посетите сайт www.cranestar.com для получения дополнительной информации.

Contents • Inhalt • Contenu • Contenido Contenuto • Índice • Содержание

Features • Besonderheiten • Caractéristiques • Caratteristiche Características • Características • Освоенности	2
Dimensions • Abmessungen • Encombrement • Dimensiones • Dimensioni • Dimensões • Размеры	5
Data • Daten • Caractéristiques • Datos • Dati • Características • Данные	6
Load charts • Traglasten • Capacités de levage • Capacidades • Capacità • Diagramas de carga Таблицы грузоподъемности	
Working Range • Arbeitsbereiche • Diagramme de levage • Gama de trabalho • Area di lavoro • Area de trabalho Грузовысотные характеристики	8
Telescopic Boom • Teleskopausleger • Flèche principale • Pluma telescópica • Braccio telescopico Lança telescópica • Телескопическая стрела	9
Swingaway • Klappspitze • Extension treillis • Plumín • Jib • Swingaway • Откидной удлинитель стрелы	13
Weight reductions • Gewichte der Lastaufnahmemittel • Reductions de charge Reducciones de peso • Riduzioni di peso • Reduções de peso • Снижение веса	16
Notes • Hinweise • Notes • Notas • Note • Notas • Примечания	17
Specification	18
Technische Daten	19
Caractéristiques techniques	20
Características	21
Caratteristiche tecniche	22
Características técnicas	23
Технические характеристики	24
Symbols • Symbolerklärung • Glossaire des symboles • Glosario de símbolos • Glossario dei simboli • Símbolos Символы	27



Manitowoc Crane Care is the Manitowoc's unparalleled product support organisation. Manitoowoc Crane Care combines all aspects of parts, service, technical documentation, technical support and training into one organisation. The program includes all of the Manitowoc's brands, which include, Potain, Grove, Manitoowoc and National Crane.

For the care of your crane and the prosperity of your business, Manitoowoc Crane Care is your single source for customer support. Wherever, whenever, whatever – we're there.

Manitoowoc Crane Care vereint alle Serviceleistungen von Manitoowoc im Produktsupport vor und nach dem Verkauf: Ersatzteile, Service, technische Dokumentation, technischer Support und Schulung, alles unter einem Dach. Dieser Service erstreckt sich auf alle Marken von Manitoowoc: Potain, Grove, Manitoowoc und National Crane.

Damit Ihr Kran leistungsfähig bleibt und Ihr Erfolg gesichert ist, bietet Ihnen Manitoowoc Crane Care einen umfassenden Support aus einer Hand. Zu jeder Zeit, an jedem Ort, für jeden Fall – wir sind für Sie da.

Organisation hors pair dédiée au support technique des produits de Manitoowoc, Manitoowoc Crane Care réunit au sein d'une même entité tous les aspects du service : pièces de rechange, service après-vente, publication technique, assistance technique et formation. Ce programme s'adresse à toutes les marques de Manitoowoc : Potain, Grove, Manitoowoc et National Crane.

Pour assurer l'entretien de vos grues et la prospérité de votre entreprise, Manitoowoc Crane Care constitue votre unique interlocuteur du service à la clientèle. Où que vous soyez, quel que soit votre besoin, vous pouvez toujours compter sur nous !

Manitoowoc Crane Care, es la organización post-venta y soporte técnico de Manitoowoc. Manitoowoc Crane Care combina todos los aspectos de piezas de repuesto, servicio, documentación técnica, apoyo técnico y formación en un único lugar. El programa también incluye todas las ramas Manitoowoc que engloba Potain, Grove, Manitoowoc y National Crane.

Para el cuidado de su grúa y la prosperidad de su negocio, Manitoowoc Crane Care, es la forma más sencilla de ayudarle. Donde sea y cuando sea, nosotros estamos allí.

Manitoowoc Crane Care è l'ineguagliabile organizzazione di supporto di Manitoowoc. Manitoowoc Crane Care gestisce tutte le attività legate a pezzi di ricambio, documentazione tecnica, assistenza tecnica e formazione riunite in un unico punto di riferimento. Questo servizio è attivo per tutti i marchi di Manitoowoc e precisamente Potain, Grove, Manitoowoc e National Crane.

Per l'assistenza delle Vostre gru e per la redditività dei Vostri investimenti, Manitoowoc Crane Care è l'insostituibile Vostra risorsa. In ogni posto, tutte le volte, per qualsiasi necessità – noi ci siamo.

Organização verdadeiramente ímpar do Manitoowoc Crane Group, é à Manitoowoc Crane Care que compete a responsabilidade pelo suporte técnico dos nossos produtos. Ela reúne, numa mesma entidade, todos os aspectos do serviço: peças de substituição, serviço pós-venda, documentação técnica, suporte técnico e formação. Este programa abrange todas as marcas do Manitoowoc Crane Group: Potain, Grove, Manitoowoc e National Crane.

Para assegurar a manutenção cuidada das suas gruas e a prosperidade do seu negócio, o seu único interlocutor do serviço de clientes é a Manitoowoc Crane CARE. Esteja onde estiver, sejam as horas que forem, precise do que precisar, pode sempre contar connosco!

Manitoowoc Crane Care - это не имеющая аналогов организация, входящая в Manitoowoc и осуществляющая техническую поддержку продукции. Manitoowoc Crane Care занимается всеми аспектами, связанными с запасными частями, услугами, технической документацией, технической поддержкой и обучением. Программа включает все торговые марки Manitoowoc, в том числе, Potain, Grove, Manitoowoc и National Crane.

Manitoowoc Crane Care является единой точкой контактов для всех клиентов компании, где они могут получить полное обслуживание для используемых ими кранов, что, в свою очередь, обеспечит процветание их бизнеса. Мы всегда там и в тот момент, где и когда мы необходимы.

Dimensions • Abmessungen • Encombremet • Dimensiones
 • Dimensioni • Dimensões • Размеры

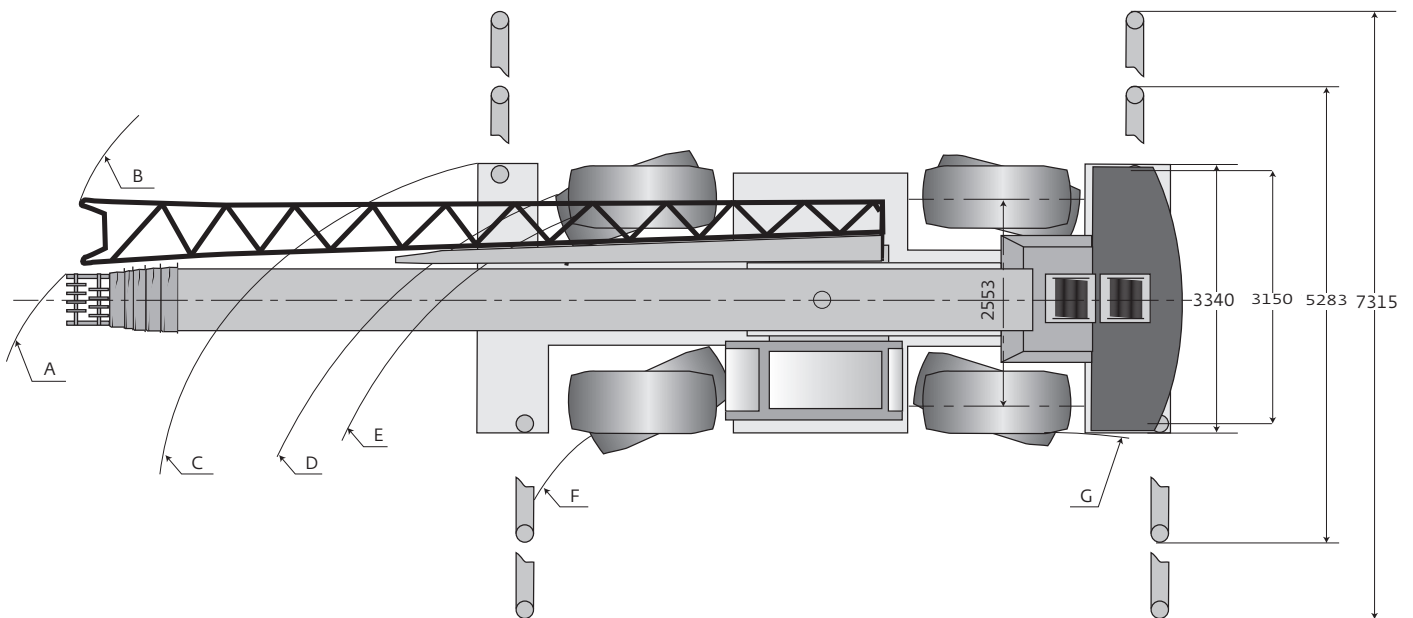
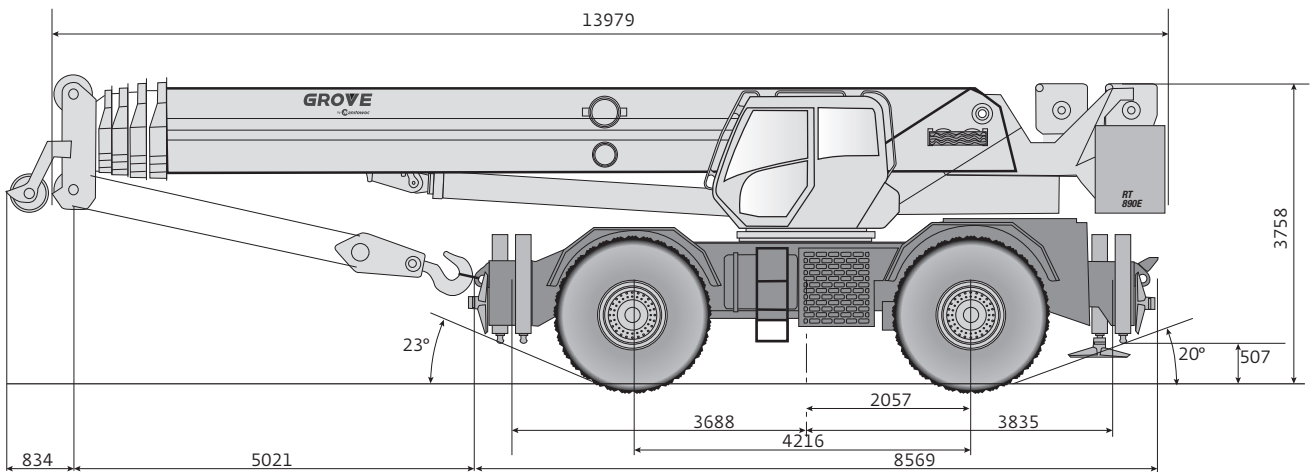

Tire size	A	B	C	D	E	F	G	A	B	C	D	E	F	G
29,5 X 25	15 700	16 300	13 600	12 900	12 500	10 100	8 800	11 100	11 600	8 400	7 800	7 300	4 900	4 100
	2 wheel steer							4 wheel steer						

Note: Reference dimensions in mm • Hinweis: Bezugsmaße in mm • Remarque : cotes de référence en mm •
 Nota: Dimensiones de referencia en mm • Nota: Dimensioni di riferimento in mm • Nota: Dimensões de referência em mm •
 Примечание: Справочные размеры (в мм)



Axle • Achse Essieu • Eje Asse • Eixos • Оси	Front Vorne Avant Delantero Anteriore Dianteiro Передняя	Rear Hinten Arriere Trasero Posteriore Traseiro Задняя	Total weight • Gesamtgewicht Poids total • Peso total Peso totale • Peso total Суммарный вес
	t	t	
Basic machine: including 43,3 m main boom, main and aux. hoist with 182,8 m of rope, manual offsetable bifold swingaway, full counterweight, 9,1 t headache ball, and 80 t hookblock. Grundauführung: Basismaschine mit 43,3 m Hauptausleger, Hauptwinde mit 182,8 m Drahtseil, Hilfswinde mit 182,9 m Drahtseil, Doppelklappspitze abgebaut, 9,1 t Gegengewicht, Drallfänger, 80 t Hakenflasche. Configuration standard comportant une flèche principale de 43,3 m, un treuil principal et un treuil auxiliaire avec 182,8 m de câble, une extension manuelle à double repliage, le contrepoids, une boule de démolition de 9,1 t, un bloc de crochet de 80 t. Máquina básica que incluye pluma principal de 43,3 m, cabrestante principal y auxiliar con 182,8 m de cable metálico, extensión manual, contrapeso, gancho de bola de 9,1 t, gancho de 80 t. Macchina base comprensiva di braccio principale da 43,3 m, argano principale e ausiliario con 182,8 m di fune metallica, falcone meccanico, contrappeso, gancio a palla da 9,1 t e bozzello da 80 t. Máquina base que inclui lança de 43,3 m, gincho principal e auxiliar com 182,8 m de cabo, extensão manual, contrapeso, gancho de bola de 9,1 t e gancho de 80 t. Базовая машина с 43,3-метровой главной стрелой, главным подъёмником с 182,8-метровым тросом, дополнительным подъёмником с 182,8-метровым стальным тросом, ручным удлинением, противовесом, 9,1-тонной шаровой баббой и 80-тонным крюкоблоком.	25,9	27,3	53,2
Substitute: Hydraulic offsetable bifold swingaway • Ersatzweise: Hydraulisch abwinkelbare Doppelklappspitze • Remplacer par un extension treillis à repliage latéral double avec déport hydraulique • Reemplazo: plumín plegable, inclinable hidráulicamente • Sostituendo con falcone ripiegabile e inclinabile idraulicamente • Substituto: extensão bipartida hidráulica • Замена: гидравлический смещаемый двухсекционный вывод	26,4	27,1	53,5
Remove counterweight, aux. Hoist (Manual. swingaway) • Gegengewicht, Hilfshubwerk (manuell abwinkelbare Klappspitze abgebaut) • Retirer le contrepoids, le treuil auxiliaire (extension manuelle) • Retirando contrapeso, cabrestante auxiliar (plumín abatible manualmente) • Rimuovere il contrappeso, l'argano ausiliario (falcone inclinabile manualmente) • Remoção de contrapeso, guincho aux. (swingaway manual) • Без противовеса, всп. лебедки (складного удлинителя стрелы (регулирование вручную)).	30,7	12,6	43,3
Remove counterweight, aux. Hoist (Hyd. swingaway) • Gegengewicht, Hilfshubwerk (hydraul. abwinkelbare Klappspitze abgebaut) • Retirer le contrepoids, le treuil auxiliaire (extension hydraulique) • Retirando contrapeso, cabrestante auxiliar (plumín abatible hidráulicamente) • Rimuovere il contrappeso, l'argano ausiliario (falcone inclinabile idraulicamente) • Remoção de contrapeso, guincho aux. (swingaway hidráulico) • Без противовеса, всп. лебедки (складного удлинителя стрелы (гидравлическое управление)).	30,9	12,5	43,4
Remove counterweight, aux. Hoist and either extension • Gegengewicht, Hilfshubwerk und Verlängerung abgebaut • Retirer le contrepoids, le treuil auxiliaire et l'une ou l'autre extension • Retirar contrapeso, cabrestante auxiliar y cualquier extensión • Togliendo il contrappeso, l'argano ausiliario ed entrambe le prolunghe • Remoção de contrapeso, guincho auxiliar e uma das extensões • Снимите противовес, вспм. лебедку и любое расширение	27,7	13,2	42,2

Load charts • Traglasten • Capacités de levage • Capacidades Capacità • Diagramas de carga • Таблицы грузоподъемности



Lifting Capacity Traglast Force de levage Capacidad de elevación Capacità di sollevamento Capacidade de elevação Грузоподъемность	Sheaves Rollen Poulies Poleas Carrucolo Roldanas Шкивы	Parts of line Stränge Brins Ramales de cable Numero di funi Partes de cabo Кратность запасовки	Total weight Gesamtgewicht Poids total Peso total Peso totale Peso total Суммарный вес
80 t	5	2 to 10	730 kg
9,1 t	H/B (swivel)	1	257 kg

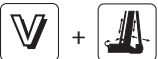

	Infinitely variable Stufenlos Progressivement variable Infinitamente variable Infinitamente variabile Infinitamente variável Плавно-изменяемый	Rope Seil Câble Cable Fune Cabo Канат	Permissible line pull max. Max. Seilzug Effort maxi au brin Tracciones del cable admisibles Trazioni ammissibili della linea Esforços admitidos nos cables Максимально допустимое натяжение каната	Nominal cable length Seillänge (Nennwert) Longueur nominale des cables Longitud nominal del cable Lunghezza nominale cavo Comprimento nominal de cabo Номинальная длина каната
	0 - 156 m/min single line / bei einfachem Strang brin simple / ramal simple tiro a fune singola / cabo singelo Однократная запасовка	19 mm (6x37 class)	7 620 kg	183 m
	0 - 156 m/min single line / bei einfachem Strang brin simple / ramal simple tiro a fune singola / cabo singelo Однократная запасовка	19 mm (Flex X 35)	7 620 kg	183 m
	0 - 2 min ⁻¹			
	20° - 78° approx. 55 s ca. 55 s • env. 55 s aproximadamente 55 s circa 55 s • cerca de 55 s примерно 55 с			
	11,4 to 43,2 m approx. 180 s ca. 180 s • env. 180 s aproximadamente 232 s circa 180 s • cerca de 180 s примерно 180 с			

Load charts • Traglasten • Capacités de levage • Capacidades Capacità • Diagramas de carga • Таблицы грузоподъемности

Working range • Arbeitsbereiche • Diagramme de levage • Gama de trabajo • Area di lavoro
Intervalo de funcionamento • Грузовысотные характеристики



11,4 – 43,2 m



100 %



360°



9,9 t

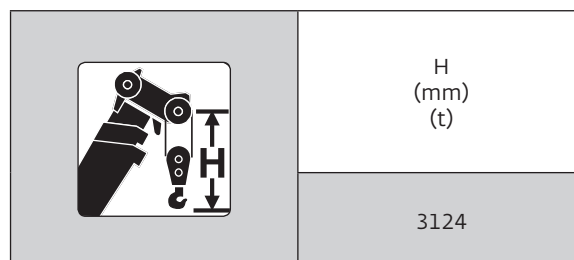
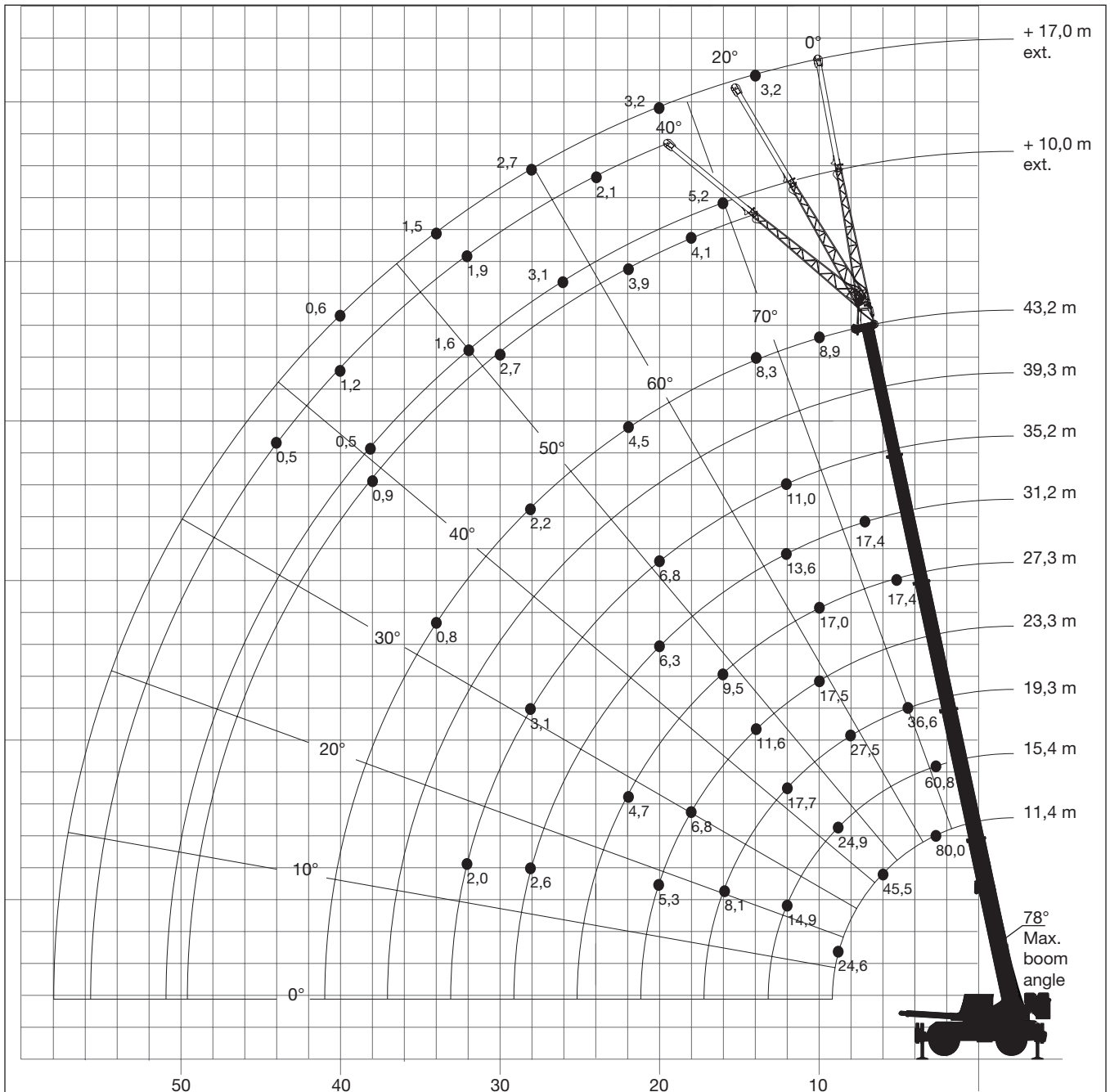

Load charts • Traglasten • Capacités de levage • Capacidades Caracità • Diagramas de carga • Таблицы грузоподъемности

Telescopic boom • Teleskopausleger • Flèche principale • Pluma telescópica • Braccio telescopico
Lança telescópica • Телескопическая стрела



11,4 - 43,2 m



100 %



360°



9,9 t



EN13000

Radius m	11,4	15,4	19,3	23,3	27,3	31,2	35,2	43,2	Radius m
3,0	80,000	60,775	36,650	-	-	-	-	-	3,0
3,5	72,500	60,775	36,650	-	-	-	-	-	3,5
4,0	66,000	59,950	36,650	17,550	-	-	-	-	4,0
4,5	59,425	58,775	36,650	17,550	-	-	-	-	4,5
5,0	54,000	53,000	35,375	17,550	17,450	-	-	-	5,0
6,0	45,475	45,000	32,450	17,550	17,450	17,400	-	-	6,0
7,0	38,975	39,100	29,850	17,550	17,450	17,400	-	-	7,0
8,0	32,650	33,000	27,450	17,550	17,450	17,300	11,050	-	8,0
9,0	24,550	26,075	24,875	17,550	17,450	17,025	11,050	-	9,0
10,0	-	21,200	20,950	17,550	17,000	15,875	11,050	8,890	10,0
12,0	-	14,925	14,725	15,675	15,075	13,575	11,050	8,640	12,0
14,0	-	-	10,775	11,575	12,325	11,800	10,850	8,280	14,0
16,0	-	-	8,080	8,820	9,525	9,970	9,440	7,780	16,0
18,0	-	-	-	6,825	7,465	7,905	8,330	6,795	18,0
20,0	-	-	-	5,300	5,910	6,340	6,770	5,530	20,0
22,0	-	-	-	-	4,690	5,120	5,545	4,500	22,0
24,0	-	-	-	-	3,695	4,140	4,565	3,645	24,0
26,0	-	-	-	-	-	3,335	3,755	2,905	26,0
28,0	-	-	-	-	-	2,645	3,080	2,240	28,0
30,0	-	-	-	-	-	-	2,505	1,680	30,0
32,0	-	-	-	-	-	-	2,000	1,195	32,0
34,0	-	-	-	-	-	-	-	0,775	34,0

AG-829-103480



85 %

Radius m	11,4	15,4	19,3	23,3	27,3	31,2	35,2	43,2	Radius m
3,0	80,000	60,775	36,650	-	-	-	-	-	3,0
3,5	73,650	60,775	36,650	-	-	-	-	-	3,5
4,0	66,225	59,950	36,650	17,550	-	-	-	-	4,0
4,5	59,425	58,775	36,650	17,550	-	-	-	-	4,5
5,0	54,550	54,725	35,375	17,550	17,450	-	-	-	5,0
6,0	45,475	45,600	32,450	17,550	17,450	17,400	-	-	6,0
7,0	38,975	39,100	29,850	17,550	17,450	17,400	-	-	7,0
8,0	32,650	34,200	27,450	17,550	17,450	17,300	11,050	-	8,0
9,0	24,550	28,300	25,350	17,550	17,450	17,025	11,050	-	9,0
10,0	-	23,125	23,100	17,550	17,000	15,900	11,050	11,050	10,0
12,0	-	16,475	16,225	17,075	15,075	13,600	11,050	11,000	12,0
14,0	-	-	12,025	12,825	13,075	11,800	10,850	9,755	14,0
16,0	-	-	9,175	9,905	10,600	10,325	9,525	8,550	16,0
18,0	-	-	-	7,785	8,425	8,855	8,425	7,475	18,0
20,0	-	-	-	6,160	6,770	7,200	7,495	6,565	20,0
22,0	-	-	-	-	5,475	5,900	6,325	5,455	22,0
24,0	-	-	-	-	4,415	4,860	5,280	4,430	24,0
26,0	-	-	-	-	-	4,000	4,425	3,585	26,0
28,0	-	-	-	-	-	3,270	3,705	2,885	28,0
30,0	-	-	-	-	-	-	3,095	2,285	30,0
32,0	-	-	-	-	-	-	2,560	1,775	32,0
34,0	-	-	-	-	-	-	-	1,330	34,0
36,0	-	-	-	-	-	-	-	0,940	36,0
38,0	-	-	-	-	-	-	-	0,585	38,0

AG-829-103458

Load charts • Traglasten • Capacités de levage • Capacidades Capacità • Diagramas de carga • Таблицы грузоподъемности

Telescopic boom • Teleskopausleger • Flèche principale • Pluma telescópica • Braccio telescopico
Lança telescópica • Телескопическая стрела



11,4 - 43,2 m



50 %



360°



9,9 t



EN13000

Radius m	11,4	15,4	19,3	23,3	27,3	31,2	35,2	43,2	Radius m
3,0	67,800	60,775	36,650	-	-	-	-	-	3,0
3,5	59,200	58,500	36,650	-	-	-	-	-	3,5
4,0	52,400	51,900	36,650	17,550	-	-	-	-	4,0
4,5	46,700	46,600	36,650	17,550	-	-	-	-	4,5
5,0	42,300	40,350	35,375	17,550	17,450	-	-	-	5,0
6,0	33,825	30,375	28,025	17,550	17,450	17,400	-	-	6,0
7,0	26,200	23,925	22,250	17,550	17,450	17,400	-	-	7,0
8,0	19,875	19,400	18,125	17,550	17,450	17,300	11,050	-	8,0
9,0	15,525	15,600	15,050	15,175	15,075	14,850	11,050	-	9,0
10,0	-	12,775	12,650	12,900	12,925	12,825	11,050	8,890	10,0
12,0	-	8,885	8,850	9,585	9,755	9,800	9,810	8,055	12,0
14,0	-	-	6,220	7,020	7,520	7,650	7,740	6,180	14,0
16,0	-	-	4,370	5,125	5,800	6,045	6,185	4,755	16,0
18,0	-	-	-	3,700	4,355	4,755	4,975	3,640	18,0
20,0	-	-	-	2,600	3,215	3,650	4,010	2,735	20,0
22,0	-	-	-	-	2,310	2,760	3,175	1,995	22,0
24,0	-	-	-	-	1,575	2,025	2,460	1,375	24,0
26,0	-	-	-	-	-	1,415	1,855	0,845	26,0
28,0	-	-	-	-	-	0,905	1,340	-	28,0
30,0	-	-	-	-	-	-	0,905	-	30,0
32,0	-	-	-	-	-	-	0,530	-	32,0

AG-829-103481



85 %

Radius m	11,4	15,4	19,3	23,3	27,3	31,2	35,2	43,2	Radius m
3,0	67,800	60,775	36,650	-	-	-	-	-	3,0
3,5	60,375	58,500	36,650	-	-	-	-	-	3,5
4,0	53,725	53,650	36,650	17,550	-	-	-	-	4,0
4,5	47,750	47,675	36,650	17,550	-	-	-	-	4,5
5,0	43,025	42,950	35,375	17,550	17,450	-	-	-	5,0
6,0	35,850	33,400	31,375	17,550	17,450	17,400	-	-	6,0
7,0	26,200	25,075	24,550	17,550	17,450	17,400	-	-	7,0
8,0	19,875	19,450	19,775	17,550	17,450	17,300	11,050	-	8,0
9,0	15,525	15,600	15,750	16,600	16,650	16,550	11,050	-	9,0
10,0	-	12,775	12,825	13,825	14,175	14,175	11,050	11,050	10,0
12,0	-	8,885	8,850	9,705	10,525	10,725	10,800	9,155	12,0
14,0	-	-	6,220	7,020	7,755	8,145	8,485	7,000	14,0
16,0	-	-	4,370	5,125	5,800	6,195	6,590	5,395	16,0
18,0	-	-	-	3,700	4,355	4,755	5,155	4,150	18,0
20,0	-	-	-	2,600	3,215	3,650	4,050	3,155	20,0
22,0	-	-	-	-	2,310	2,760	3,175	2,335	22,0
24,0	-	-	-	-	1,575	2,025	2,460	1,635	24,0
26,0	-	-	-	-	-	1,415	1,855	1,050	26,0
28,0	-	-	-	-	-	0,905	1,340	0,560	28,0
30,0	-	-	-	-	-	-	0,905	-	30,0
32,0	-	-	-	-	-	-	0,530	-	32,0

AG-829-103459

Load charts • Traglasten • Capacités de levage • Capacidades Caracità • Diagramas de carga • Таблицы грузоподъемности

Telescopic boom • Teleskopausleger • Flèche principale • Pluma telescópica • Braccio telescopico
Lança telescópica • Телескопическая стрела

 11,4 - 43,2 m
  0%
  360°
  9,9 t



EN13000

Radius m	11,4	15,4	19,3	23,3	27,3	31,2	35,2	43,2	Radius m
3,0	44,750	38,575	34,250	-	-	-	-	-	3,0
3,5	36,200	31,675	28,500	-	-	-	-	-	3,5
4,0	30,025	26,600	24,150	17,550	-	-	-	-	4,0
4,5	25,375	22,700	20,775	17,550	-	-	-	-	4,5
5,0	21,800	19,650	18,050	17,550	17,125	-	-	-	5,0
6,0	16,600	15,050	13,975	13,950	13,700	13,375	-	-	6,0
7,0	13,000	11,775	11,050	11,225	11,175	11,025	-	-	7,0
8,0	9,860	9,380	8,820	9,180	9,255	9,205	9,135	-	8,0
9,0	7,460	7,515	7,075	7,540	7,720	7,755	7,755	-	9,0
10,0	-	6,020	5,680	6,205	6,480	6,570	6,630	5,045	10,0
12,0	-	3,795	3,585	4,185	4,550	4,755	4,885	3,475	12,0
14,0	-	-	2,095	2,735	3,145	3,395	3,605	2,305	14,0
16,0	-	-	1,000	1,640	2,075	2,360	2,595	1,400	16,0
18,0	-	-	-	0,790	1,240	1,545	1,795	0,675	18,0
20,0	-	-	-	-	0,570	0,885	1,150	-	20,0
22,0	-	-	-	-	-	-	0,620	-	22,0

Ag-829-103481







85 %



Radius m	11,4	15,4	19,3	23,3	27,3	31,2	35,2	43,2	Radius m
3,0	49,400	45,500	36,650	-	-	-	-	-	3,0
3,5	40,800	36,575	33,575	-	-	-	-	-	3,5
4,0	33,450	30,275	28,025	17,550	-	-	-	-	4,0
4,5	28,000	25,575	23,850	17,550	-	-	-	-	4,5
5,0	23,850	21,950	20,550	17,550	17,450	-	-	-	5,0
6,0	17,875	16,375	15,725	15,850	15,725	15,475	-	-	6,0
7,0	13,125	12,400	12,350	12,650	12,725	12,625	-	-	7,0
8,0	9,860	9,630	9,850	10,275	10,450	10,475	10,475	-	8,0
9,0	7,460	7,585	7,820	8,335	8,695	8,800	8,860	-	9,0
10,0	-	6,020	6,175	6,725	7,235	7,440	7,550	6,025	10,0
12,0	-	3,795	3,805	4,420	4,955	5,385	5,555	4,200	12,0
14,0	-	-	2,195	2,820	3,400	3,885	4,115	2,865	14,0
16,0	-	-	1,035	1,665	2,250	2,740	3,010	1,845	16,0
18,0	-	-	-	0,790	1,380	1,830	2,135	1,040	18,0
20,0	-	-	-	-	0,700	1,110	1,430	-	20,0
22,0	-	-	-	-	-	0,535	0,850	-	22,0

Ag-829-103460

Load charts • Traglasten • Capacités de levage • Capacidades Capacità • Diagramas de carga • Таблицы грузоподъемности



Telescopic boom • Teleskopausleger • Flèche principale • Pluma telescópica • Braccio telescopico
Lança telescópica • Телескопическая стрела

 11,4 - 43,2 m
  0 km/h
  360°
  9,9 t

  EN13000





Radius m	11,4	15,4	19,3	23,3	Radius m
4,0	17,925	18,875	-	-	4,0
4,5	17,000	17,325	8,585	7,110	4,5
5,0	14,725	14,925	8,585	7,110	5,0
6,0	11,100	11,075	8,585	7,110	6,0
7,0	8,330	8,370	8,240	7,110	7,0
8,0	6,140	6,365	6,455	6,850	8,0
9,0	4,365	4,835	4,895	5,515	9,0
10,0	-	3,625	3,620	4,430	10,0
12,0	-	1,845	1,885	2,625	12,0



AG-829-1(034)5

  85 %

Radius m	11,4	15,4	19,3	23,3	Radius m
4,0	17,925	18,875	-	-	4,0
4,5	17,925	18,850	8,585	7,110	4,5
5,0	16,300	16,975	8,585	7,110	5,0
6,0	12,475	12,550	8,585	7,110	6,0
7,0	9,930	9,860	8,345	7,110	7,0
8,0	7,520	7,595	7,500	7,110	8,0
9,0	5,515	5,725	5,710	6,520	9,0
10,0	-	4,360	4,360	5,300	10,0
12,0	-	2,450	2,605	3,225	12,0



AG-829-01(03467A)

 11,4 - 43,2 m
  4,0 km/h
  0°
  9,9 t

  EN13000

Radius m	11,4	15,4	19,3	23,3	Radius m
4,0	18,875	18,900	-	-	4,0
4,5	18,875	18,900	10,150	7,110	4,5
5,0	18,200	18,225	10,150	7,110	5,0
6,0	16,575	16,675	10,150	7,110	6,0
7,0	14,100	14,325	10,150	7,110	7,0
8,0	11,800	12,125	10,150	7,110	8,0
9,0	9,765	10,175	10,150	7,110	9,0
10,0	-	8,170	8,335	7,110	10,0
12,0	-	5,370	5,600	6,210	12,0
14,0	-	-	3,765	4,400	14,0
16,0	-	-	2,455	3,090	16,0

AG-829-10-496

  85 %

Radius m	11,4	15,4	19,3	23,3	Radius m
4,0	18,875	18,900	-	-	4,0
4,5	18,875	18,900	10,150	7,110	4,5
5,0	18,200	18,225	10,150	7,110	5,0
6,0	16,575	16,675	10,150	7,110	6,0
7,0	14,100	14,325	10,150	7,110	7,0
8,0	11,800	12,125	10,150	7,110	8,0
9,0	9,930	10,325	10,150	7,110	9,0
10,0	-	8,870	9,025	7,110	10,0
12,0	-	6,470	6,715	7,110	12,0
14,0	-	-	4,970	5,630	14,0
16,0	-	-	3,635	4,310	16,0

AG-829-01(03467A)

Load charts • Traglasten • Capacités de levage • Capacidades Caracità • Diagramas de carga • Таблицы грузоподъемности

Swingaway • Klappspitze • Extension treillis • Plumín • Falcone • Swingaway • Складной удлинитель стрелы



11,4 - 43,2 m



10,0 - 17,0 m



100 %



360°



9,9 t



EN13000

Radius in m	10,0 m			17,0 m			Radius in m
	0°	20°	40°	0°	20°	40°	
12,0	5,200	-	-	-	-	-	12,0
14,0	5,200	5,200	-	3,160	-	-	14,0
16,0	5,200	5,110	-	3,160	-	-	16,0
18,0	5,100	4,920	4,060	3,160	2,550	-	18,0
20,0	4,915	4,745	3,975	3,160	2,465	-	20,0
22,0	4,635	4,590	3,900	2,850	2,405	-	22,0
24,0	3,825	4,350	3,835	2,850	2,340	2,050	24,0
26,0	3,140	3,610	3,775	2,710	2,280	2,005	26,0
28,0	2,555	2,975	3,295	2,705	2,275	1,965	28,0
30,0	2,045	2,420	2,695	2,330	2,175	1,930	30,0
32,0	1,600	1,935	2,170	1,890	2,125	1,900	32,0
34,0	1,210	1,505	1,705	1,500	2,050	1,870	34,0
36,0	0,860	1,110	1,270	1,155	1,650	1,845	36,0
38,0	0,530	0,745	0,870	0,850	1,295	1,590	38,0
40,0	-	-	-	0,570	0,970	1,200	40,0
42,0	-	-	-	-	0,680	0,850	42,0
44,0	-	-	-	-	-	0,535	44,0

AG-829-103407

Radius in m	22,0 m			27,0 m			Radius in m
	5°	20°	40°	5°	20°	40°	
18,0	2,900	-	-	-	-	-	18,0
20,0	2,900	2,900	-	2,265	-	-	20,0
22,0	2,900	2,900	-	2,265	2,265	-	22,0
24,0	2,900	2,900	2,500	2,265	2,265	-	24,0
26,0	2,200	2,340	2,450	1,495	1,605	1,730	26,0
28,0	2,150	2,295	2,260	1,470	1,570	1,730	28,0
30,0	2,060	2,240	2,090	1,430	1,530	1,725	30,0
32,0	1,610	2,060	1,935	1,390	1,495	1,630	32,0
34,0	1,215	1,620	1,790	1,215	1,460	1,480	34,0
36,0	0,855	1,225	1,600	0,865	1,245	1,345	36,0
38,0	0,540	0,875	1,200	0,550	0,900	1,220	38,0
40,0	-	0,555	0,840	-	0,580	0,895	40,0
42,0	-	-	0,505	-	-	0,570	42,0

AG-829-103899A

Load charts • Traglasten • Capacités de levage • Capacidades Capacità • Diagramas de carga • Таблицы грузоподъемности

Swingaway • Klappspitze • Extension treillis • Plumín • Falcone • Swingaway • Складной удлинитель стрелы



11,4 - 43,2 m



10,0 - 17,0 m



100 %



360°



9,9 t



85 %

Radius in m	10,0 m			17,0 m			Radius in m
	0°	20°	40°	0°	20°	40°	
12,0	6,210	-	-	-	-	-	12,0
14,0	6,210	5,890	-	3,245	-	-	14,0
16,0	6,210	5,795	-	3,245	-	-	16,0
18,0	6,210	5,565	4,575	3,245	2,900	-	18,0
20,0	6,200	5,375	4,480	3,245	2,825	-	20,0
22,0	5,905	5,180	4,395	3,245	2,745	-	22,0
24,0	5,085	5,015	4,315	3,245	2,665	2,285	24,0
26,0	4,195	4,615	4,235	3,235	2,595	2,230	26,0
28,0	3,455	3,825	4,005	3,125	2,530	2,185	28,0
30,0	2,825	3,155	3,500	3,015	2,465	2,145	30,0
32,0	2,280	2,580	2,865	2,735	2,410	2,110	32,0
34,0	1,815	2,080	2,310	2,250	2,350	2,080	34,0
36,0	1,400	1,640	1,830	1,820	2,290	2,050	36,0
38,0	1,040	1,255	1,400	1,445	1,870	2,025	38,0
40,0	0,715	0,910	-	1,110	1,495	1,730	40,0
42,0	-	0,605	-	0,810	1,160	1,355	42,0
44,0	-	-	-	0,540	0,860	1,020	44,0
46,0	-	-	-	-	0,585	0,720	46,0

AG-829-103469A

Radius in m	22,0 m			27,0 m			Radius in m
	5°	20°	40°	5°	20°	40°	
18,0	2,900	-	-	-	-	-	18,0
20,0	2,900	2,900	-	2,265	-	-	20,0
22,0	2,900	2,900	-	2,265	2,265	-	22,0
24,0	2,900	2,900	2,500	2,265	2,265	-	24,0
26,0	2,895	2,725	2,450	2,265	2,260	2,020	26,0
28,0	2,755	2,490	2,260	2,220	2,110	1,970	28,0
30,0	2,500	2,275	2,090	2,025	1,900	1,790	30,0
32,0	2,275	2,090	1,935	1,820	1,715	1,630	32,0
34,0	1,965	1,915	1,790	1,625	1,545	1,480	34,0
36,0	1,550	1,760	1,655	1,460	1,395	1,345	36,0
38,0	1,185	1,515	1,535	1,250	1,255	1,220	38,0
40,0	0,855	1,150	1,415	0,920	1,130	1,105	40,0
42,0	0,560	0,830	1,065	0,625	0,910	0,995	42,0
44,0	-	0,540	0,735	-	0,620	0,855	44,0

AG-829-103597

Load charts • Traglasten • Capacités de levage • Capacidades Caracità • Diagramas de carga • Таблицы грузоподъемности

Swingaway • Klappspitze • Extension treillis • Plumín • Falcone • Swingaway • Складной удлинитель стрелы



11,4 - 43,2 m



10,0 - 17,0 m



50 %



360°



9,9 t



EN13000

Radius in m	10,0 m			17,0 m			Radius in m
	0°	20°	40°	0°	20°	40°	
12,0	5,200	-	-	-	-	-	12,0
14,0	5,200	5,200	-	3,160	-	-	14,0
16,0	4,745	5,110	-	3,160	-	-	16,0
18,0	3,710	4,425	4,060	3,160	2,550	-	18,0
20,0	2,870	3,505	3,975	3,115	2,465	-	20,0
22,0	2,175	2,740	3,200	2,440	2,405	-	22,0
24,0	1,590	2,095	2,495	1,865	2,340	2,050	24,0
26,0	1,090	1,540	1,890	1,380	2,150	2,005	26,0
28,0	0,660	1,065	1,365	0,955	1,660	1,965	28,0
30,0	-	0,650	0,910	0,585	1,225	1,750	30,0
32,0	-	-	0,505	-	0,840	1,310	32,0
34,0	-	-	-	-	0,500	0,910	34,0
36,0	-	-	-	-	-	0,555	36,0

AG-829-103498



85 %

Radius in m	10,0 m			17,0 m			Radius in m
	0°	20°	40°	0°	20°	40°	
12,0	6,210	-	-	-	-	-	12,0
14,0	6,210	5,890	-	3,245	-	-	14,0
16,0	5,465	5,795	-	3,245	-	-	16,0
18,0	4,290	5,050	4,575	3,245	2,900	-	18,0
20,0	3,350	4,015	4,480	3,245	2,825	-	20,0
22,0	2,575	3,165	3,650	2,880	2,745	-	22,0
24,0	1,930	2,460	2,875	2,245	2,665	2,285	24,0
26,0	1,385	1,855	2,215	1,705	2,515	2,230	26,0
28,0	0,915	1,335	1,650	1,240	1,970	2,185	28,0
30,0	0,510	0,885	1,155	0,835	1,500	1,945	30,0
32,0	-	-	0,720	-	1,085	1,455	32,0
34,0	-	-	-	-	0,715	1,030	34,0
36,0	-	-	-	-	-	0,655	36,0

AG-829-103465A

Load charts • Traglasten • Capacités de levage • Capacidades Capacità • Diagramas de carga • Таблицы грузоподъемности

Weight reductions • Gewichtsreduzierung durch Lastaufnahmemittel • Reductions de charge
Reducciones de peso • Riduzioni di peso • Reduções de peso • Снижение веса

Auxiliary boom nose / Hilfsrollenkopf / Tête de flèche auxiliaire / Cabeza auxiliar / Falconcino ausiliario in testa al braccio / Cabeçote da lança auxiliar / Вспомогательный оголовок стрелы	60 kg
Hookblocks / Hakenflaschen / Moufles / Ganchos / Ganci / Cadernais / Крюковой блок	
85 tonne 5 sheave / Seilrollen / Réas / Poleas / Carrucole / Roldanas / блок	590 kg
73 tonne 5 sheave / Seilrollen / Réas / Poleas / Carrucole / Roldanas / блок	725 kg
9,1 tonne overhaul ball / 9,1 t Kugelhaken / Crochet simple de 9,1 tonnes / Ganho de bola de 9,1 toneladas / Bozzello a palla da 9,1 tonnellate / Bola e gancho de 9,1 toneladas / 9,1-крюк с шаром утяжелителем	258 kg
10-17 m bifold swingaway fly jib / Doppelklappspitze / Extension de flèche repliable / Plumín Plegable / Prolunga ripiegabile del braccio / Extensão da lança articulada. / складной удлинитель стрелы	
10 m erected / Klappspitze vorgebaut / Déplié / Montado / Montato / Montado / смонтированный	1 700 kg
17 m erected / Klappspitze vorgebaut / Déplié / Montado / Montato / Montado / смонтированный	3 630 kg

Note: All load handling devices and boom attachments are considered part of the load and suitable allowances must be made for their combined weights.

Hinweis: Alle Lastaufnahmemittel und jede Zusatzausrüstung des Hauptauslegers werden als Teil der Traglast betrachtet und ihre kombinierten Gewichte müssen beim Feststellen der Nettolast entsprechend berücksichtigt (abgezogen) werden.

Remarque : Les équipements complémentaires et accessoires de levage sont considérés comme faisant partie de la charge; les réductions de charges de leurs poids combinés doivent être effectuées.

Nota: Todos los aparos de elevacion e implementos de pluma son considerados parte de la carga y deben ser tenidos en cuenta para calcular los pesos a elevar.

Nota: Tutti gli accessori di sollevamento e le opzioni montate sul braccio sono considerati parte del carico e devono essere richieste adeguate autorizzazioni per l'uso dei loro pesi complessive.

Nota: Todos os acessórios de elevação e opcionais de lança contribuem para a carga a elevar pelo que devem ser tidos em conta nos cálculos dos pesos a elevar

Примечание: Все погрузочно/разгрузочные устройства и дополнительные приспособления стрелы считаются частью нагрузки, поэтому в общем весе для них нужно учитывать некоторые допущения.

Load charts • Traglasten • Capacités de levage • Capacidades Capacità • Diagramas de carga • Таблицы грузоподъемности

Notes • Hinweise • Notes • Notas • Note • Notas • Примечания

The lifting capacities correspond to EN 13000:2010-10 and 85 %.

Warning: THIS CHART IS ONLY A GUIDE. The Notes below are for illustration only and should not be relied upon to operate the crane. The individual crane's load chart, operating instructions and other instruction plates must be read and understood prior to operating the crane.

The lifting capacities likewise fulfil the requirements of ISO 4305 and DIN 15019, Part 2, with regard to stability, and DIN 15018, Part 3, and FEM 5004 with regard to strength.

85%: Capacities are in accordance with SAE J1063 and do not exceed 85% of the tipping load (SAE J1289 for outriggers 50% and 0% extended) as determined by SAE J765.

1. Capacities given do not include the weight of hookblocks, slings, auxiliary lifting equipment and load handling devices. Their weights MUST be added to the load to be lifted. When more than minimum required reeving is used, the additional rope weight shall be considered part of the load.
2. All capacities are for crane on firm, level surface. It may be necessary to have structural supports under the outrigger floats or tyres to spread the load to a larger bearing surface.
3. When either boom length or radius or both are between values listed, the smallest load shown at either the next larger radius or boom length shall be used.
4. For outrigger operation, ALL outriggers shall be fully extended with tyres raised free of ground before raising the boom or lifting loads.
5. Tyres shall be inflated to the recommended pressure before lifting on rubber.

Die Tragfähigkeiten entsprechen EN 13000:2010-10 und 85 %.

WARNUNG: DIESE TABELLE IST LEDIGLICHE EINE RICHTLINIE. Die Hinweise dienen als Erklärung und sind für die Kranbedienung nicht maßgebend. Vor Inbetriebnahme des Kranes sind Traglasttabellen, Bedienungsanleitung und andere Vorschriften eingehend zu studieren.

Die Tragfähigkeitswerte erfüllen ebenfalls die Anforderungen von ISO 4305 und DIN 15019 Teil 2 bezüglich Standsicherheit sowie von DIN 15018 Teil 3 und FEM 5004 bezüglich Festigkeit.

85%: Tragkraftwerte entsprechen SAE J1063 und überschreiten nicht 85 % der Kipplast (SAE J1289 bei halb- bzw. ganz ausgefahrener Abstützung) gemäß Richtlinien SAE J765.

1. Das Gewicht der Hakenflaschen und aller Anschlagmittel muß zu der Last hinzugerechnet werden. Beim Einscheren mit erhöhten Werten ist das zusätzliche Seilgewicht als Teil der Last zu betrachten.
2. Alle Werte gelten für den Kran auf festem, ebenem Untergrund. Eventuell müssen die Stützteller oder Reifen unterlegt werden, um die Last über eine größere Abstützfläche zu verteilen.
3. Wenn Auslegerlänge oder Radius oder beide Werte zwischen den aufgeführten Werten liegen, ist die geringere der Traglasten zu wählen, die für den die nächstgrößere Ausladung oder die nächste bzw. anschließende Auslegerlänge genannt sind.
4. In abgestütztem Zustand müssen ALLE Stützen komplette ausgefahren sein. Die Reifen dürfen den Boden nicht berühren. Erst danach dürfen Lasten oder der Ausleger angehoben werden.
5. Bevor frei auf Rädern gearbeitet wird, müssen, die Reifen mit dem vorschrittsmäßigen Druck aufgefüllt werden.

Les capacités de levage sont conformes à la norme EN 13000:2010-10 et 85 %.

ATTENTION: CE TABLEAU N'EST QU'UN GUIDE. Les notes ci-dessous sont données à titre d'exemple et ne devront pas être utilisées pour faire fonctionner la grue. Toute la documentation concernant chaque type de grue: tableau des charges, instructions de fonctionnement et toutes autres plaques d'instructions devront être lues et comprises avant de manoeuvrer la grue.

Les capacités de levage respectent également les exigences des normes ISO 4305 et DIN 15019, paragraphe 2, relatives à la stabilité, ainsi que celles des normes DIN 15018 paragraphe 3 et FEM 5004 relatives à la résistance.

85% : Les capacités de levage sont conformes à la norme SAE J1063 et ne dépassent pas 85% de la charge de basculement (SAE J1289 pour les poutres de calage déployées à 50% et 0%) tel que cela est prescrit par la norme SAE J765.

1. Les charges mentionnées dans les tableaux ne comprennent pas le poids des moufles, des élingues et autres accessoires de levage qui doit être additionné à celui de la charge levée. Lorsque le mouflage est supérieur au minimum requis le poids de l'excédent de câble doit être additionné à celui de la charge.
2. Les capacités sont données sur sol ferme et de niveau. Il peut être nécessaire d'utiliser des bastingis ou des accessoires similaires afin de répartir la charge transmise au sol par les roues ou les patins de calage.
3. Lorsque la longueur de flèche ou la portée ne correspond pas aux valeurs mentionnées dans les tableaux, il convient de se référer à la valeur inférieure mentionnée pour la portée ou la longueur de flèche immédiatement supérieure.
4. Pour utilisation machine calée, les poutres de calage doivent être totalement télescopées et les roues décollées du sol avant de relever la flèche ou de lever des charges.
5. Les pneumatiques devront être gonflés aux pressions préconisées avant tout levage en libre.

Las capacidades de carga corresponden a EN 13000:2010-10 y 85 %.

AVISO: ESTA TABLA ES SOLO UNA ORIENTACION. Las notas que aparecen al final de la misma solo sirven de ilustración y no deben ser tomadas como instrucciones para operar la grúa. La tabla de cargas, las instrucciones de operación y otras placas ilustrativas de cada grúa deben ser leídas y correctamente interpretadas antes de operar la grúa.

Asimismo los valores de carga cumplen las disposiciones de las normas ISO 4305 y DIN 15019, 2.ª parte, respecto a la estabilidad, y DIN 15018, 3.ª parte, y FEM 5004 respecto a la fuerza.

85%: La capacidad de sollevamento sono conformi alla norma SAE J1063 e non superano l'85% del carico di ribaltamento (SAE J1289 per gli stabilizzatori estesi al 50% e 0%) come prescritto dalla norma SAE J765.

1. Las cargas indicadas no incluyen el peso de los ganchos, eslingas, equipos auxiliares y aparejos de elevación. Sus pesos DEBEN ser añadidos al de la carga a elevar. Cuando se utilice un número de ramales de cable superior al necesario, el peso adicional del cable debe ser considerado como parte de la carga.
2. Todas las capacidades corresponden a la grúa situada sobre terreno firme nivelado y uniforme. La naturaleza del terreno puede hacer necesario colocar, bajo los apoyos de los estabilizadores o bajo los neumáticos, elementos estructurales que repartan la carga sobre una mayor superficie de apoyo.
3. Cuando se trabaje con longitudes de pluma o rádios, intermedios entre los valores reflejados en las tablas, se considerará la carga inmediata inferior indicada en el radio o longitud de pluma inmediato superior.
4. Para trabajos sobre estabilizadores, TODOS los estabilizadores estarán totalmente extendidos y los neumáticos sin tocar el suelo antes de elevar pluma o izar cargas.
5. Los neumáticos deberán estar inflados a la presión recomendada antes de elevar cargas sobre neumáticos.

Le tabelle di portata sono conformi alle norme EN 13000:2010-10 e 85 %.

ATTENZIONE: QUESTA TABELLA E' SOLO UNA GUIDA. Le note qui sotto riportate sono date a titolo d'esempio e non devono essere utilizzate per far funzionare la grua.

La tabella di carico, le istruzioni d'uso ed ogni altro foglio illustrativo devono essere letti e compresi prima di manovrare la grua.

I valori delle tabelle di portata sono conformi anche ai requisiti delle norme ISO 4305 e DIN 15019, Parte 2, per quanto riguarda la stabilità, ed alle norme DIN 15018, Parte 3, e FEM 5004 per quanto riguarda il calcolo di resistenza della struttura.

85%: Capacidades de acuerdo con las Normas SAE J1063 y no exceden del 85% del momento de vuelco (Normas SAE J1289 para las cargas sobre estabilizadores extendidos al 50% o sin extender 0%) como fijan las normas SAE J765.

1. I carichi indicati nelle tavole non comprendono il peso dei ganci, dei tiranti, e di nessun altro accessorio di sollevamento che deve essere aggiunto a quello del carico sollevato. Quando il numero di funi è superiore al minimo richiesto il peso addizionale della fune deve essere aggiunto a quello del carico.
2. Tutte le capacità si intendono per la gru situata su un terreno compatto livellato e uniforme. Potrebbe rendersi necessario utilizzare dei supporti strutturali, sotto gli appoggi degli stabilizzatori o sotto i pneumatici, per ripartire il carico su una superficie di appoggio maggiore.
3. Quando la lunghezza del braccio o la portata non corrispondono ai valori riportati nelle tabelle, conviene considerare il valore inferiore riportato per il raggio di lavoro o la lunghezza del braccio immediatamente superiore.
4. Per lavoro su stabilizzatori, TUTTI gli stabilizzatori devono essere completamente estesi e i pneumatici staccati da terra prima di rialzare il braccio o di sollevare carichi.
5. I pneumatici devono essere gonfiati alla pressione raccomandata prima di sollevare carichi sopra i pneumatici.

Capacidade de carga corresponde a EN 13000:2010-10 e 85 %.

Atenção: ESTE QUADRO SERVE APENAS DE GUIA. As notas abaixo são dadas a mero título exemplificativo e não deverão ser utilizadas para operar a grua. Toda a documentação e instruções relativas a cada tipo de grua, nas quais se incluem o diagrama de carga da grua, as respectivas instruções de operação e outras placas com instruções, têm de ser lidas e compreendidas antes de a grua ser operada.

Capacidade de elevação também satisfazer os requisitos da norma ISO 4305 e DIN 15019, Parte 2, a estabilidade relativa, bem como os da DIN 15018 3 e GEF 5004 no que diz respeito à sua resistência.

85%: As capacidades estão de acordo com a norma SAE J1063 e não excedem 85%, da carga de capotamento (SAE J1289 para os estabilizadores a 50% e a 0%) como determinado pela norma SAE J765.

1. As capacidades indicadas não incluem o peso de cadernais, eslingas, equipamento auxiliar de elevação e dispositivos de manuseamento de cargas. Os seus pesos TÊM de ser adicionados ao peso da carga a ser elevada. Sempre que for utilizada mais de que uma desmultiplicação de cabo, o peso adicional dos cabos deverá ser considerado parte da carga, devendo ser adicionado ao seu peso.
2. Todas as capacidades são indicadas para uma grua sobre uma superfície firme e nivelada. Pode ser necessário colocar suportes estruturais por baixo dos pneus ou das sapatas dos estabilizadores, para espalhar a carga por uma superfície de suporte maior.
3. Sempre que o comprimento da lança, o seu raio, ou ambos estiverem compreendidos entre os valores indicados, deve ser utilizada a carga mais baixa indicada para o raio ou para o comprimento de lança imediatamente superior.
4. Operação com estabilizadores: Antes de a lança ser erguida ou de serem elevadas cargas, TODOS os estabilizadores têm de estar totalmente estendidos, com os pneus erguidos de modo a não estarem em contacto com o solo.
5. Antes de serem elevadas cargas sobre os pneus, eles devem ser enchidos às pressões recomendadas.

Грузоподъемность соответствует EN 13000:2010-10 и 85 %.

Внимание: ДАННАЯ СХЕМА ПРИВЕДЕНА ИСКЛЮЧИТЕЛЬНО В ОЗНАКОМИТЕЛЬНЫХ ЦЕЛЯХ. Нижеприведенные данные являются лишь пояснительными, на них не следует полагаться при работе с краном. Перед работой на кране следует прочесть и понять таблицы грузоподъемности, инструкцию по эксплуатации, а также инструктирующие таблички.

Кроме того, грузоподъемность удовлетворяет требованиям ISO 4305 и DIN 15019 (часть 2) в отношении устойчивости, и DIN 15018, (часть 3), и FEM 5004 в отношении прочности материала.

85%: Нагрузка соответствует стандарту SAE J1063 и не превышает 85% от удерживающего момента (SAE J1289 для выносных опор, выдвигаемых на 50% и на 0%) в соответствии с SAE J765.

1. Указанная нагрузка не учитывает вес крюковых блоков, канатов, вспомогательного подъемного оборудования и погрузочно/разгрузочных устройств. Их вес СЛЕДУЕТ прибавлять к массе груза. При превышении минимально необходимой запоски канатаследует учитывать его дополнительный вес.
2. Все нагрузки указаны для крана, находящегося на прочной плоской поверхности. С целью распределения нагрузки, под выносные опоры или под колеса можно подложить поддерживающие конструкции для увеличения площади опоры.
3. Если длина стрелы, вылет (или и то и другое) находятся между указанными значениями в таблице, следует брать наименьшую нагрузку, указанную за следующим значением радиуса или длины стрелы.
4. Перед подъемом стрелы или грузы (при использовании выносных опор) следует выдвинуть ВСЕ выносные опоры на полную длину, чтобы колеса оказались над землей.
5. При подъеме с колес, шины должны быть накачаны до рекомендуемого давления.

Specification

Superstructure



Boom

11,4 m – 43,2 m, five-section, full power boom. Maximum tip height: 45,7 m.



*Bifold swingaway extension

10,0 m - 17,0 m hydraulic offsettable bifold lattice swingaway extension. Offsets 0°, 20° and 40°. Stows alongside base boom section. Maximum tip height: 62,7 m.



*Insert

2 x 4,8 m lattice extension inserts. Installs between the boom nose and bifold extension, non-stowable. Maximum tip height: 72,5 m.



Boom elevation

One double acting hydraulic cylinder with integral holding valve provides elevation from -3° to +78°.



Load moment and anti-two block system

Standard “Graphic Display” load moment and anti-two block system with audio-visual warning and control lever lockout. These systems provide electronic display of boom angle, length, radius, tip height, relative load moment, maximum permissible load, load indication and warning of impending two-block condition. The standard Work Area Definition System allows the operator to pre-select and define safe working areas. If the crane approaches the pre-set limits, audio-visual warnings aid the operator in avoiding job-site obstructions.



Cab

Full-vision, all-steel fabricated with acoustical lining and tinted safety glass throughout. Cab tilts to +20 degrees. Deluxe seat incorporates armrest-mounted hydraulic single-axis controllers. Dash panel incorporates gauges for all engine functions. Other standard features include: hot water heater, cab circulating air fan, sliding side and rear windows, sliding skylight with electric wiper and sunscreen, electric windshield wash/wipe, fire extinguisher and seat belt. Air conditioning (28 500 BTU).



Slewing

Two speed, planetary swing drive with foot applied multi-disc wet brake. Spring applied, hydraulically released swing brake. Single position mechanical house lock, operated from cab. Maximum speed: 2,0 RPM.



Counterweight

9 979 kg. Hydraulically installed and removed.



Hydraulic system

Two main pumps ([1] piston and [1] gear) with a combined capacity of 503 LPM. Maximum operating pressure: 277,7 bar. Three section pressure compensated valve bank. Return line type filter with full flow by-pass protection and service indicator. Replaceable cartridge with micron filtration rating of 5/12/16. 995 L hyd. reservoir. Carrier mounted oil cooler with thermostatically controlled hydraulic motor driven fan/air to oil. System pressure test ports.



Hoist

Planetary reduction with automatic spring applied multi-disc wet brake. Electronic hoist drum rotation indicators, and hoist drum cable followers.

Maximum Single Line Pull:

- 1st layer: 9 185 kg. • 3rd layer: 7 716 kg.
- 5th layer: 6 650 kg.

Maximum Permissible Line Pull: 7 620 kg with 6X37 class rope.

7 620 kg with 35X7 Rotation Resistant rope.

Maximum Single Line Speed: 156 m/min.

Rope Construction: 6X36 EIPS IWRC, Special Flexible

35x7 Flex-X, Rotation Resistant

Rope Diameter: 19mm.

Rope Length: Main Hoist: 183 m - Auxiliary Hoist: 183 m.

Maximum Rope Stowage: 256 m.



CraneSTAR

Crane asset management system.

Carrier



Carrier frame

Box section frame fabricated from high-strength, low alloy steel. Front/rear towing and tie down lugs.



Outriggers

Four hydraulic telescoping single-stage double box beam outriggers with inverted jacks and integral holding valves. Three position setting, 0%, 50% and fully extended. All steel fabricated, quick release type outrigger floats, 775 mm diameter. Maximum outrigger pad load: 56 700 kg. Controls and crane level indicator located in cab.



Engine

Engine (Tier III): Cummins QSB 6,7L diesel, six cylinders, turbocharged, 205 kW at 2 500 RPM. Maximum torque: 987 Nm at 1 500 RPM.

Note: Required for sale outside of North American and European Union countries

Engine (Tier IV): Cummins QSB 6.7 l diesel, six cylinders, turbocharged with Cummins Diesel Particulate Exhaust filter/muffler. Meets emissions per U.S.E.P.A. Tier IV and E.U. Stage III B. 205 kW at 2500 rpm. Maximum torque: 992 Nm at 1500 rpm. Fuel requirement: Maximum of 15 ppm sulphur content (Ultra Low Diesel Fuel).

Note: Tier IV engine Required in North American and European Union countries.

Fuel tank capacity: 280 l.



Transmission

Full ranges shift with 6 forward and 6 reverse speeds.

Front axle disconnect for 4 x 2 travel.



Drive/Steer

4 x 4.

Fully independent power steering:

Front: Full hydraulic steering wheel controlled.

Rear: Full hydraulic switch controlled.

Provides infinite variations of 4 main steering modes: front only, rear only, crab and coordinated. Rear steer indicator. Turning radius: 7,8 m.



Axles

Front: Drive/steer with differential and planetary reduction hubs rigid mounted to frame.

Rear: Drive/steer with differential and planetary reduction hubs pivot mounted to frame.



Tyres

Std. 29,5 x 25 - 34 bias ply, General.



Brakes

Full hydraulic split circuit operating on all wheels. Spring-applied, hydraulically released parking brake mounted on front axle.



Lights

Full lighting including turn indicators, head, tail, brake and hazard warning lights.



Maximum speed

35 km/h.



Electrical system

Two 12 V - maintenance free batteries. 12 V starting and lighting. Battery disconnect. CanBus Diagnostic system.

* Optional equipment

- Auxiliary lighting package (includes cab mounted amber flashing light, hoist mounted work light, and dual base boom mounted floodlights).
- LMI light bar (in cab).
- 360° NYC style mechanical swing lock.
- Rear Pintle hook.
- Cab controlled cross axle differential locks, (front and rear).
- PAT data logger.
- Rubber mat for storage trough.

*Denotes optional equipment

Kranoberwagen



Ausleger

Fünfteiliger, voll teleskopierbarer Ausleger, 11,4 m bis 43,2 m Länge. Maximale Rollenhöhe 45,7 m.



*Doppelklappspitze

Hydraulisch abwinkelbare Doppelklappspitze in Gitterbauweise, 10,0 bis 17,0 m Länge. Abwinkelung 0°, 20° und 40°. Maximale Arbeitshöhe : 62,7 m.



*Teleskopklappspitze

Zwei (2) Zwischenstücke in Gitterbauweise, jeweils 4,8 m lang. Anbau zwischen Auslegerkopf und Doppel-Klappspitze, nicht verstaubar. Maximale Rollenhöhe: 72,5 m.



Wippwerk

Ein doppelt wirkender Hydraulikzylinder mit integriertem Sicherheits-Rückschlagventil. Auslegerverstellwinkel von -3° bis +78°.



Lastmoment- und Hubendschalter-System

System für Lastmomentbegrenzung über Standard-„Grafikdisplay“ und Anti-Two Block System mit akustisch-optischer Warnung und Steuerhebelsperre. Diese Systeme bieten elektronische Anzeige von Auslegerwinkel, Auslegerlänge, Radius, Arbeitshöhe, relativem Lastmoment, maximal zulässiger Last, Hakenlast und Hubendschaltungs-Vorrichtung. Das zur Standardausrüstung gehörende System zur Arbeitsbereichsbegrenzung ermöglicht es dem Bediener, sichere Arbeitsbereiche vorzugeben und zu definieren. Nähert sich der Kran der Begrenzung des sicheren Arbeitsbereichs, wird der Bediener akustisch und optisch gewarnt, wodurch Kollisionen am Einsatzort vermieden werden.



Kabine

Rundsichtkabine, in Stahlblech ausgeführt, mit Schalldämmung und getöntem Sicherheitsglas. Kabine lässt sich um +20 Grad neigen. Komfortsitz mit in den Armlehnen integrierten, einachsigen verstellbaren Steuerhebeln. Armaturenbrett mit Anzeigen für alle Motorfunktionen. Weitere Standardausrüstung: Heißwasserheizung, Umluftgebläse, Schiebefenster seitlich und hinten, Dachschiebefenster mit elektrischem Scheibenwischer und Sonnenschutz, elektrischer Frontscheibenwischer/Waschanlage, Feuerlöscher und Sicherheitsgurt. Klimaanlage (28 500 BTU).



Schwenkwerk

Zweistufiges Planetenschwenkwerk mit fußbetätigter Mehrscheiben-Ölbadbremse. Hydraulisch lösbare Federspeicher-Feststellbremse. Von der Kabine aus in einer Stellung festsetzbare Bolzenverriegelung. Max. Drehgeschwindigkeit: 2,0 U/min.



Gegengewicht

Gegengewicht 9 979 kg, hydraulisch an- und abbaubar.



Hydrauliksystem

Zwei Hauptpumpen ([1] Kolben- und [1] Zahnradpumpe), Gesamtfördermenge 503 l/min. Maximaler Betriebsdruck: 277,7 bar. Druckkompensierter Ventilblock in drei Abschnitten. Filter mit Vollstrom-Bypassschutz und Wartungsanzeige im Rücklauf. Wechsellpatrone mit einer Filtrierleistung von 5/12/16 Mikron. Fassungsvermögen des Hydrauliköltanks : 995 Liter. Am Chassis angebaute Ölkühler mit thermostatisch geregelter, vom Hydraulikmotor angetriebenem Lüfter/Luft-zu-Öl. Systemdruck-Prüfanschlüsse.



Hubwerk

Planetengetriebe mit automatischer Federspeicher-Mehrscheibenbremse im Ölbad. Elektronischer Hubwerksumdrehungs-Melder sowie Seilführungsbügel. Maximaler Seilzug mit einfachem Strang:

• Erste Lage:	9 185 kg.	• Dritte Lage:	7 716 kg.
• Fünfte Lage:	6 650 kg.		

Maximal zulässiger Seilzug: 7 620 kg mit Seil Kategorie 6 x 37
7 620 kg mit 35x7 Flex-X, drallfrei.

Maximale Seilgeschwindigkeit mit einfachem Strang: 156 m/min.
Seilaufbau : 6X36 EIPS IWRC, besonders flexibel.

35x7 Flex-X, drallfrei..

Seildurchmesser: 19mm.

Seillänge: Haupthubwerk : 183 m. Hilfshubwerk : 183 m.

Hubwinde für max. 256 m Seil ausgelegt.



CraneSTAR

Flottenmanagementsystem.

Kranunterwagen



Rahmen

Kastenprofilrahmen aus hochfestem Feinkornstahl. Abschlepp- und Verzurrösen vorne/hinten.



Abstützungen

Vier hydraulisch teleskopierbare, einteilige Kastenprofil-Abstützträger mit innen geführten Stützzyllindern und integrierten Halteventilen. Drei Stellungen: 0%, 50% und voll ausgefahren. Abstützteller mit Schnellentriegelung aus Stahl, Durchmesser 775 mm, maximaler Stützdruck per Teller 56 700 kg. Bedienelemente und Nivellieranzeige in der Kabine.



Motor

Tier III : Cummins QSB 6,7 Liter Sechszylinder-Dieselmotor, Turbolader, 205 kW bei 2 500 U/Min. Max. Drehmoment : 987 Nm bei 1 500 U/Min.

Hinweis: Dieser Motor ist zum Verkauf außerhalb der Europäischen Union und Nordamerikas bestimmt.

Tier IV : Cummins QSB 6,7 Liter Sechszylinder-Dieselmotor Turbolader und Cummins-Dieselfußpartikelfilter/-dämpfer. Entspricht Emissionsvorgaben nach U.S.E.P.A. Tier IV und E.U. Stufe III B. 205 kW bei 2 500 U/Min.

Max. Drehmoment : 992 Nm bei 1 500 U/Min. Kraftstoffanforderung: Maximal 15 ppm Schwefelanteil (besonders schwefelarmer Dieseldieselkraftstoff). Hinweis: Dieser Motor ist zum Verkauf in Nordamerika und der Europäischen Union bestimmt.

Kraftstoffbehälter: 280 l.



Getriebe

Gruppenschaltung mit 6 Vorwärts- und 6 Rückwärtsgängen. Abkoppelung der Vorderachse für 4 x 2 Antrieb.



Antrieb/Lenkung

4 x 4.

Separate Servolenkung :

Vorne : Vollhydraulisch, über Lenkrad betätigt.

Hinten : Vollhydraulisch, über Schalter betätigt.

Stellt vier stufenlos veränderliche Lenkkarten bereit : Nur vorne, nur hinten, Hundegang und koordiniert. Lenkungsanzeige hinten. Wendekreis : 7,8 m.



Achslinien

Vorne: Antrieb/Lenkung über Differenzial und Planetenuntersetzungsgetriebe, fest mit dem Rahmen verbunden.

Hinten: Antrieb/Lenkung über Differenzial und Planetenuntersetzungsgetriebe, pendelnd mit dem Rahmen verbunden.



Bereifung

Standard 29,5 x 25 – 34-lagig, Diagonalreifen, General



Bremsen

Vollhydraulische Bremsen mit geteilten Bremskreisen, auf alle Räder wirkend. Hydraulisch lösbare Federspeicher-Feststellbremse, auf die Vorderachse wirkend.



Beleuchtung

Volle Beleuchtungsanlage mit Blinkleuchten, Scheinwerfern, Schluss- und Bremsleuchten und Warnblinkanlage.



Höchstgeschwindigkeit

35 km/h.



Elektrische Anlage

Zwei wartungsfreie 12-Volt-Batterien. 12-Volt-Starter und Beleuchtungsanlage. Batterie-Trennschalter. Diagnose über CAN-Datenbus.

* Zusatzausrüstung

- Zusatzbeleuchtungspaket (einschl. kabinenmontierte Rundumwarnleuchte [orange], hubwerksmontierte Arbeitsleuchte und zwei am Ausleger-Grundstück montierte Flutlichter).
- LMB Leuchtenleiste (in der Kabine).
- Mechanische Schwenkwerksverriegelung, 360 Grad, Typ NYC.
- Abschleppöse hinten.
- Differenzialsperren (vorne und hinten), von der Kabine aus zuschaltbar.
- PAT Datalogger.
- Gummimatte für Staufach.

*Kennzeichnet wahlweise Zusatzausrüstung

Caractéristiques techniques

Superstructure



Flèche

11,4 m – 43,2 m. Flèche télescopique hydraulique, à cinq éléments.
Hauteur maximale de tête de flèche : 45,7 m.



*Extension treillis

Extension treillis hydraulique à double repliage latéral de 10 m à 17 m avec possibilité de déport à 0°, 20° et 40°. Hauteur max. de tête d'extension : 62,7 m.



*Éléments intermédiaires pour extension de treillis

2 éléments intermédiaires de 4,8 m pour extension treillis installés entre la tête de flèche principale et l'extension treillis double ; éléments transportés séparément.
Hauteur max. d'extension treillis : 72,5 m.



Relevage

Un vérin hydraulique double effet avec clapet anti-retour intégré. Angles de relevage -3° à +78°.



Contrôleur d'état de charge et dispositif de fin de course haute crochet indépendant

En standard, contrôleur d'état de charge à affichage graphique et dispositif de course haute avec alarmes sonores et visuelles et dispositif de coupure des mouvements. Ces dispositifs donnent un affichage graphique de l'angle et de la longueur de flèche, de la portée, de la hauteur de tête de flèche, du moment relatif, de la charge maximum autorisée, de la charge levée et de sécurité de fin de course haute crochet. Le dispositif standard de limitation du domaine d'évolution (Work Area Definition System) permet à l'utilisateur de pré-définir et limiter le domaine de travail autorisé.



Cabine

Cabine panoramique tout acier avec isolation sonore et vitrages de sécurité teintés, inclinable à 20°. Siège ergonomique équipé de manipulateurs multidirectionnels électriques doubles-axes intégrés aux accoudoirs. Tableau de bord équipé de tous les instruments nécessaires à la surveillance du moteur. Autres équipements montés en standard : colonne de direction réglable en inclinaison, chauffage de cabine à eau chaude, ventilateur, vitrages coulissants latéraux et arrière, vitre de toit coulissante équipée d'un essuie-glace et d'un rideau pare-soleil, essuie-glace et lave-glace de pare-brise, extincteur et ceinture de sécurité. Dispositif d'air conditionné (28 500 BTU).



Orientation

Réducteur d'orientation à planétaires, frein multi-disques immergés à commande au pied. Frein de rotation à ressort à débrayage hydraulique. Verrouillage de sécurité mécanique à une position, actionné depuis la cabine. Vitesse maximale : 2 tpm.



Contrepoids

Contrepoids de 9 979 kg à mise en place et dépose hydraulique.



Système hydraulique

Deux pompes principales, une à pistons et une à engrenages, donnant un débit combiné de 503 litres/min. Pression maximum de service : 277,7 bars. Distributeur hydraulique trois éléments avec compensateurs de pression. Filtre hydraulique sur circuit de retour avec protection par dérivation plein débit et indicateur de colmatage. Cartouche amovible avec classe de filtration micrométrique 5/12/16. Réservoir hydraulique de 995 litres. Prises de pressions rapides.



Treuil

Entraînement par réducteur à planétaires et frein multi-disques immergés. Indicateurs électroniques de rotation du treuil et dispositif presse-câble.

Efforts max. sur brin simple :

- 1^{ère} couche : 9 185 kg.
- 3^e couche : 7 716 kg.
- 5^e couche : 6 650 kg.

Effort max. autorisé sur brin simple : 7 620 kg avec câble de classe 34x37.

Vitesse max. de déroulement : 171 m/min.

Câbles antigiratoires type 6 x 36 EIPS IWRC, Special Flexible ou 35x7 Flex-X.
Diamètre : 19 mm.

Longueur de câble : Treuil principal : 183 m et auxiliaire : 183 m

Capacité maximum de câble : 256 m



CraneSTAR

Système de gestion de parc de grues.

Châssis



Châssis

Châssis caissonné mécanosoudé en acier à haute limite élastique.
Chapes de remorquage et d'arrimage à l'avant et à l'arrière.



Dispositif de calage

Quatre poutres de calage hydrauliques télescopiques avec vérins inversés et clapets anti-retour intégrés. Calage autorisé en trois positions : 0 – 50% et 100%.
Patins d'appui carrés (775 mm de diamètre) en acier avec dispositifs de fixation rapide. Charge maximum sur appui : 56 700 kg
Commandes de calage et indicateur de niveau dans la cabine.



Moteur

Tier III : Moteur Diesel 6 cylindres Cummins QSB 6,7L turbocompressé développant 205 kW à 2 500 tours/min. Couple maximum : 987 Nm à 1 500 tours/min. Note : Requis pour les ventes hors des pays d'Amérique du Nord et de l'Union européenne.

Tier IV : Moteur Diesel à turbocompresseur 6 cylindres Cummins QSB 6,7L avec filtre/silencieux d'échappement à particules Cummins diesel. Respecte les exigences en matière d'émissions selon l'U.S.E.P.A. Tier IV et U.E. Phase III B. Développant 205 kW à 2 500 tours/min. Couple maximum : 992 Nm à 1 500 tours/min.

Exigences relatives au carburant : Maximum de 15 ppm de teneur en soufre (carburant diesel à très faible teneur). Note : Moteur Tier IV requis dans les pays d'Amérique du Nord et de l'Union européenne.

Capacité du réservoir : 280 l



Boîte de vitesse

Boîte de vitesses « range shift » à 6 rapports avant et 6 rapports arrière. Débrayage de pont avant pour déplacement en 4 x 2.



Direction/transmission

4 x 4.

Direction hydraulique indépendante :

Avant : Direction hydraulique indépendante actionnée par volant.

Arrière : Direction hydraulique indépendante commandée par interrupteur au tableau de bord.

Combinaisons infinies des quatre modes de direction : avant uniquement, arrière uniquement, marche en crabe et mode coordonné. Indicateur de direction arrière.
Rayon de braquage : 7,8 m.



Ponts

Avant : Pont moto-directeur avec différentiel et réductions à planétaires dans les moyeux fixé de manière rigide au châssis.

Arrière : Pont moto-directeur avec différentiel et réductions à planétaires dans les moyeux articulé au châssis.



Pneumatiques

Pneumatiques standard 29,5 x 25 à carcasse conventionnelle 34 plis.



Freins

Freinage sur toutes les roues avec circuit scindé. Frein de stationnement à serrage par ressorts et desserrage hydraulique sur l'essieu avant.



Eclairage

Eclairage complet incluant les clignotants, ainsi que les feux avant, arrière, de freinage et de détresse.



Vitesse maximum

35 km/h.



Installation électrique

Deux batteries sans entretien de 12 Volts pour l'éclairage et le démarrage. Coupe circuit. Système de diagnostic Can Bus.

* Equipements optionnels

- Ensemble d'éclairage auxiliaire (inclut le girophare orange sur cabine, le feu de travail sur treuil et deux phares de travail montés à l'extrémité du caisson de base).
- Barrette d'affichage CEC (en cabine).
- Verrouillage mécanique d'orientation 360° (type "Ville de New York").
- Crochet de remorquage.
- Différentiels inter-roues commandés depuis la cabine (avant et arrière).
- Enregistreur de données PAT data logger.
- Tapis en caoutchouc pour le coffre de stockage.

*Équipements optionnels

Superestructura



Pluma

Pluma totalmente hidráulica de cinco secciones, de 11,4 - 43,2 m.
Altura máxima en punta al suelo : 45,7 m.



*Plumín de celosía

Plumín de celosía articulado en dos secciones de 10,0 m - 17,0 m.
Angulable hidráulicamente a 0°, 20°, 40°, y plegable junto al tramo base de la pluma. Altura máxima en punta: 62,7 m.



*Extensión de pluma de celosía

2 secciones de extensión de pluma de celosía de 4,8 m. Se instalan entre la cabeza de la pluma y el plumín de celosía, no se pueden plegar junto al tramo base de la pluma. Altura máxima en punta : 72,5 m.



Elevación de pluma

Un cilindro hidráulico de doble efecto con válvula de retención integrada logrando elevación entre -3° y +78°.



Sistema indicador del momento de carga y de final de carrera del gancho

Momento de carga estándar "con indicador gráfico" y sistema antibloqueo doble con señal de aviso sonora y visual y bloqueo de la palanca de control. Estos sistemas proporcionan la visualización en una pantalla electrónica del ángulo, longitud, radio, altura de la punta al suelo, momento de carga relativo, carga máxima admisible, indicación de carga y aviso del estado del bloqueo doble inminente de la pluma. El sistema de definición del área de trabajo estándar permite al operario preseleccionar y definir zonas de trabajo seguras. Si la grúa se acerca a los límites predefinidos, una señal de aviso sonora y visual ayuda al operario a evitar obstrucciones en el lugar de la obra.



Cabina

Cabina de visión panorámica, toda ella fabricada en acero con revestimiento acústico y cristal de seguridad tintado por completo. La cabina bascula hasta +20 grados. Asiento de lujo que incorpora los controles eléctricos de operación montados en reposabrazos. El panel de instrumentos incorpora indicadores para todas las funciones del motor. Forman parte del equipo de serie: volante regulable en altura, calefacción de agua, ventilador para la cabina, ventanillas laterales y traseras deslizantes, ventana superior abatible con limpia-parabrisas eléctrico y parasol, extintor y cinturón de seguridad. Aire acondicionado (28.500 BTU).



Rotación

Dos velocidades, giro deslizante mediante planetarios con freno de discos múltiples accionado por pedal. Freno de giro accionado mediante resorte con desconexión hidráulica. Bloqueo interno mecánico de una única posición accionado desde la cabina. Velocidad máxima: 2 rpm.



Contrapeso

9 979 kg. Instalado y desmontado hidráulicamente.



Sistema hidráulico

Dos bombas principales (una de pistón y una de engranaje) con una capacidad combinada de 503 lpm. Presión de funcionamiento máxima: 277,7 bar. Banco de válvula de presión compensada de tres secciones. Filtro en la línea de retorno con protección by-pass de flujo e indicador de mantenimiento. Cartucho reemplazable con una tasa de microfiltrado de 5/12/16. Depósito de aceite hidráulico de 995 l. Puertos de prueba de presión del sistema.



Especificaciones del mecanismo de elevación principal y auxiliar

Reducción planetaria con freno automático de discos múltiples aplicado mediante resorte. Tambor acanalado con indicadores electrónicos de rotación del tambor. Tensión máxima de un solo ramal de cable:

- Primera capa: 9 185 kg.
- Tercera capa: 7 716 kg.
- Quinta capa: 6 650 kg.

Tracción máxima admisible del cable: 7 620 kg con cable de clase 34x37.
7 620 kg con cable 35 x 7 antirrotación.

Velocidad máxima de un solo cable: 156 m/min
Estructura del cable : 6x36 EIPS IWRC, flexible especial. 35x7 Flex-X, antirrotación.
Diámetro del cable : 19 mm.
Longitud del cable : Cabrestante principal : 183 m y auxiliar : 183 m.
Capacidad máxima de cable en el tambor : 256 m.



CraneSTAR

Sistema de gestión de flotas de grúas.

Chasis



Bastidor

Estructura tipo cajón fabricada en acero de alta resistencia y baja aleación.
Orejetas de amarre delanteras y traseras.



Estabilizadores

Cuatro estabilizadores hidráulicos telescópicos de doble viga con gatos invertidos y válvulas de retención integradas. Tres ajustes de posición: 0%, 50% y totalmente extendidos. Base de los estabilizadores de montaje rápido, fabricadas completamente en acero de 775 mm de diámetro.

Carga máxima sobre cada placa de apoyo: 56 700 kg.
Controles e indicador del nivel de la grúa situados en la cabina.



Motor

Tier III : Cummins QSB 6,7L diesel seis cilindros, turboalimentado, 205 kW a 2 500 rpm. Par motor máximo : 987 Nm a 1 500 rpm. Nota: Necesario para la venta fuera de los países norteamericanos y de la Unión Europea.

Tier IV : Cummins QSB 6,7L diesel seis cilindros turboalimentado, con silenciador/filtro Cummins de tubo escape de partículas diésel. Cumple los estándares de emisiones Tier IV de la U.S.E.P.A. y Fase IIIB de la U.E. 205 kW a 2 500 rpm. Par motor máximo : 992 Nm a 1 500 rpm. Exigencias de combustible: máximo de 15 ppm de contenido de azufre (diesel de muy bajo contenido en azufre). Nota: motor Tier IV necesario en los países norteamericanos y de la Unión Europea. Capacidad del depósito de combustible: 280 litros.



Transmisión

Rango total de desplazamiento con 6 velocidades de avance y otras 6 de marcha atrás. Desconexión del eje frontal para un desplazamiento 4 x 2.



Tracción/Dirección

4 x 4.

Dirección totalmente asistida independiente entre ejes :

Delantera : Totalmente hidráulica, controlada por volante.

Trasera : Totalmente hidráulica, controlada por interruptor.

Infinitamente variable en los 4 modos de dirección principales : sólo delantera, sólo trasera, control de giro (tipo cangrejo) y coordinada. Indicador de dirección trasera. Radio de giro: 7,8 m.



Ejes

Delantero : Tracción/dirección con reducción planetaria y diferencial, montaje rígido en la estructura.

Trasero : Tracción/dirección con reducción planetaria y diferencial, montaje pivotante en la estructura.



Neumáticos

Estándar 29,5 x 25 - 34 lonas, común.



Frenos

Circuito de frenos totalmente hidráulico operando sobre todas las ruedas. Freno de estacionamiento montado sobre el eje delantero que se acciona mediante resorte y se libera hidráulicamente.



Luces

Iluminación completa que incluye intermitentes, indicadores superiores, traseros, de freno y de peligro.



Velocidad máxima

35 km/h.



Sistema eléctrico

Dos baterías de 12V sin mantenimiento. Arranque e iluminación de 12V. Desconexión de la batería. Sistema de diagnóstico CanBus.

* Equipos especiales

- Paquete de iluminación auxiliar (incluye luz intermitente ámbar montada sobre la cabina, luz de trabajo montada en el mecanismo de elevación y luces de resalte dobles montadas en la pluma base).
- Barra de iluminación del LMI (en la cabina).
- Bloqueo de oscilación estilo NYC de 360 grados.
- Gancho trasero con pasador de cadena.
- Bloqueos del diferencial de eje cruzado controlados desde la cabina (delanteros y traseros).
- Registrador de datos PAT.
- Alfombrilla de goma para hueco de almacenamiento.

*Indica equipo opcional.

Caratteristiche tecniche

Sovrastruttura



Braccio

Braccio a piena potenza a cinque sezioni da 11,4 m a 43,2 m. Altezza massima in punta: 45,7 m.



*Jib ripiegabile

Falcone tralicciato inclinabile idraulicamente da 10,0 - 17,0 m. Inclinabile a 0°, 20° e 40°. Alloggiabile lungo la sezione del braccio. Altezza massima in punta: 62,7 m.



*Inserti

2 x 4,8 m sezioni intermedie tralicciate. Installabili tra la punta del braccio ed il falcone, non alloggiabili lungo il braccio. Altezza massima in punta: 72,5 m.



Sollevamento braccio

Un cilindro idraulico a doppia azione con valvola di blocco integrale fornisce il sollevamento braccio con angolo da -3° a +78°.



Limitatore di carico e finecorsa

Momento di carico standard con display grafico, sistema anti-doppio bloccaggio con allarme e bloccaggio dei movimenti. Visualizzazione grafica dell'angolo del braccio, lunghezza, raggio, altezza in punta, indicazione del carico e del carico ammissibile massimo. Il sistema standard di definizione dell'area di lavoro permette all'operatore di preselezionare e definire le aree di lavoro sicure. Se l'autogru si avvicina ai limiti preimpostati, degli allarmi acustici e visivi aiutano l'operatore ad evitare gli ostacoli sul posto di lavoro.



Cabina

Ottima visibilità, costruita completamente in acciaio, insonorizzata. La cabina si inclina fino a +20°. Il sedile ergonomico è dotato di comandi elettrici a doppio asse integrati nei braccioli. Il cruscotto incorpora la strumentazione per tutte le funzioni del motore. Altre caratteristiche standard comprendono: volante inclinabile, riscaldamento ad acqua, ventola per la circolazione dell'aria nella cabina, finestrini scorrevoli, lava/tergicristallo elettrico, estintore e cintura di sicurezza. Aria condizionata (28.500 BTU).



Rotazione

Doppia velocità di rotazione con riduttore planetario e freno idraulico a disco multiplo azionato a pedale. Freno di stazionamento a molla rilasciato idraulicamente. Bloccaggio con perno meccanico in posizione frontale con azionamento dalla cabina. Velocità massima: 2,0 giri/minuto.



Contrappeso

8 979 kg. Installato e rimosso idraulicamente.



Impianto idraulico

2 pompe principali (una a pistoni assiali e una a ingranaggi) con capacità totale di 503 l/min. Pressione operativa massima: 277,7 bar. Valvola di controllo principale a tre sezioni a pressione compensata. Filtro sulla linea di ritorno non bypassabile e indicatore di manutenzione. Cartuccia sostituibile con microfiltraggio di 5/12/16. Capacità del serbatoio idraulico: 995 l. Prese per la misura della pressione del sistema. Scambiatori di calore di serie per l'olio idraulico e l'olio della trasmissione.



Specifiche dell'organo principale e ausiliario

Riduttore planetario e freno negativo multidisco ad azionamento automatico. Indicatore elettronico di rotazione del tamburo sul joystick e guide per cavo tamburo organo.

Tiro massimo con singola fune:

- Primo strato: 9 185 kg.
- Terzo strato: 7 716 kg.
- Quinto strato: 6 650 kg.

Tiro massimo permesso sulla fune: 7 620 kg con fune di classe 6X37.

7 620 kg con fune di classe 35X7, resistente alla rotazione.

Velocità massima con singola fune : 156 m/min.

Costituzione della fune: 6 x 36 EIPS IWRC, flessibilità speciale 35x7 Flex-X, resistente alla rotazione.

Diametro fune : 19 mm.

Lunghezza della fune : sull'organo principale e ausiliario : 183 m

Massima capacità di avvolgimento della fune sul tamburo : 256 m.



CraneSTAR

Sistema di gestione della flotta gru.

Carro



Telaio

Costruito con sezioni realizzate in acciaio ad alta resistenza. Punto di fissaggio per traino anteriore e posteriore.



Stabilizzatori

Quattro stabilizzatori ad azionamento idraulico e cilindri a stelo rovesciato, valvole di blocco integrali. Impostazione a tre posizioni, 0%, 50% e completamente estesi. Costruzione completamente in acciaio, piattini stabilizzatori quadrati del tipo a rilascio rapido, con lato 775 mm. Carico massimo piattini stabilizzatori: 56 700 kg. Comandi e indicatore di livello della gru situati all'interno della cabina.



Motore

Tier III : Diesel Cummins QSB da 6,7 l, 6 cilindri con turbocompressore, 205 kW a 2500 giri al minuto. Coppia max : 987 Nm a 1500 giri al minuto. Nota: richiesto per vendita al di fuori dei paesi del Nord America e dell'Unione Europea.

Tier IV : Diesel Cummins QSB da 6,7 l, 6 cilindri con turbocompressore con sistema di post-trattamento costituito dal filtro antiparticolato Cummins DPF, 205 kW a 2500 giri al minuto. Coppia max : 992 Nm a 1500 giri al minuto. Conforme ai requisiti richiesti per le emissioni secondo E.P.A. (United States) Tier IV e EUROMOT (Comunità Europea) Stadio 3B. Carburante richiesto: diesel con contenuto massimo di zolfo 15 ppm (Ultra Low Diesel Fuel). Nota: il motore Tier IV / Euromot 3B è richiesto nei paesi del Nord America e dell'Unione Europea.

Capacità serbatoio: 280 l



Cambio

Con 6 marce avanti e 6 retromarcia. Scollegamento assale anteriore per marcia 4 x 2.



Trazione/Sterzo

4 x 4.

Idroguida completamente indipendente:

Anteriore : completamente idraulico azionato tramite il volante.

Posteriore : completamente idraulico azionato con interruttore.

Fornisce 4 modalità di sterzata: solo anteriore, solo posteriore, a granchio e combinata. Indicatore di allineamento delle ruote posteriori.

Raggio di sterzo : 7,8 m.



Assali

Anteriore : Montato rigido sul telaio, trazione con differenziale e mozzini di riduzione planetaria.

Posteriore : Su colla oscillante, trazione con differenziale e mozzini di riduzione planetaria montati.



Pneumatici

Standard 29,5 x 25 - 24 strati trasversali, General.



Freni

Doppio circuito completamente idraulico agente su tutte le ruote.

Freno di stazionamento negativo ad azionamento idraulico agente sull'asse anteriore.



Luci

Illuminazione completa compresi indicatori di direzione, luci anteriori, posteriori, freno e luci di segnalazione pericolo.



Velocità massima

35 km/h.



Impianto elettrico

2 batterie da 12 V. Avviamento e illuminazione a 12 V.

Interruttore di disconnessione, sistema di controllo CANbus.

* Equipaggiamenti opzionali

- Pacchetto di illuminazione ausiliario (comprende luci lampeggianti ambra montate in cabina, luce di lavoro montata sull'organo, e proiettori montati su braccio a base doppia).
- Barra luminosa LMI (in cabina).
- Bloccaggio meccanico della rotazione a 360° (tipo NYC).
- Gancio del rimorchio posteriore.
- Bloccaggio differenziali trasversali controllati dalla cabina (anteriore e posteriore).
- Registratore di dati PAT.
- Tappetino di gomma vano di stivaggio.

*Indica attrezzature opzionali

Superestrutura



Lança

Lança de cinco secções, potência total, 11,4 m – 43,2 m.
Altura máxima da ponta da lança : 45,7 m.



*Extensão swingaway fixa

Extensão swingaway treliçada de dobragem dupla angulável hidráulica, 10,0 m - 17,0 m. Angulações de 0°, 20° e 40°. Acondiciona-se ao longo da secção da lança base. Altura máx. da cabeça da extensão: 62,7 m.



*Extensão swingaway telescópica

2 extensões de 4,8 m da estrutura. Instalam-se entre a ponta da lança e a extensão bipartida, não acondicionáveis. Altura máx. da cabeça da extensão: 72,5 m.



Elevação da lança

Um cilindro hidráulico de acção dupla com válvula anti-retorno integral assegura a elevação de -3° a +78°.



Sistema de momento de carga e fim de curso do cadernal

“Indicador gráfico” standard do momento de carga e do sistema de fim de curso do cadernal com sistema audiovisual de sinalização e dispositivo de bloqueio automático das alavancas de comando. Estes sistemas fornecem informações, apresentadas em visor electrónico, do ângulo da lança, do comprimento, do raio, da altura da ponta da lança, do momento de carga relativo, da carga máxima admitida, da indicação de carga e aviso sobre o fim de curso do cadernal. O Sistema de Definição da Área de Trabalho standard permite ao operador seleccionar previamente e definir áreas de trabalho. Se a grua se estiver a aproximar dos limites previamente definidos, avisos audiovisuais ajudam o operador a evitar obstruções no local da obra.



Cabine

Cabine panorâmica, integralmente feita de aço, com isolamento sonoro e vidro de segurança colorido a toda a volta. Cabine inclinável até +20 graus. O assento Deluxe integra controladores de eixo duplo, eléctricos, instalados no apoio para os braços. O painel de controlo está equipado com manómetros para todas as funções do motor. Entre as demais funcionalidades standard incluem-se: Volante inclinável, aquecedor da cabine de água quente, ventoinha de circulação do ar na cabine, janelas lateral e traseira deslizantes, vidro de tejadilho deslizante com limpa-vidros eléctrico e pala para o sol, lava e limpa pára-brisas eléctricos, extintor de incêndios e cinto de segurança. Ar condicionado (28.500 BTU).



Rotação

Accionamento da rotação de planetários, de 2 velocidades, com travão em banho de óleo, tipo multidisco com aplicação com o pé. Travão de imobilização de mola e de libertação hidráulica. Dispositivo de bloqueio mecânico, de uma posição, accionado a partir da cabine. Velocidade máxima : 2,0 rpm.



Contrapeso

8 979 kg. Instalado e desmontado por meios hidráulicos.



Sistema hidráulico

Duas bombas principais (1 de pistão e 1 de engrenagens) com uma capacidade combinada de 503 l/min). Pressão de serviço máxima: 277,7 bar. Três conjuntos de válvulas de pressão compensada. Filtro no circuito de retorno com protecção por derivação de débito total e indicador de manutenção. Cartucho substituível com classe de filtragem micrométrica de 5/12/16. Depósito de 995 l. Tomadas para teste da pressão do sistema.



Guincho

Redutor de planetários com travão em banho de óleo multidiscos de mola, automático. Indicadores electrónicos da rotação do tambor de elevação e acamador de cabo no tambor de elevação. Esforço máximo no cabo singelo:

- Primeira camada: 9 185 kg.
- Terceira camada: 7 716 kg.
- Quinta camada: 6 650 kg.

Esforço máximo admitido no cabo singelo: 7 620 kg com cabo da classe 6x37.
7 620 kg com cabo da classe 35x7 resistente à rotação.

Velocidade máxima do cabo singelo : 156 m/min.

Tipo de Cabo: 6x37 EIPS IWRC, flexível especial. 35x7 Flex-X resistente à rotação. Diâmetro do Cabo: 19 mm.

Comprimento do cabo: Guincho principal : 183 m e auxiliar : 183 m.

Capacidade Máxima do Cabo : 256 m.



CraneSTAR

Sistema de gestão de frotas de gruas.

Chassis



Chassis do transportador

Chassis de caixa em aço de alta resistência. Olhais de fixação e de reboque dianteiros e traseiros.



Estabilizadores

Quatro vigas de estabilização hidráulicas e telescópicas, de caixa dupla, de secção simples, com macacos invertidos e válvulas anti-retorno integrais. Três posições : 0%, 50% e totalmente estendidas. Sapatas de apoio, integralmente feitas de aço, de libertação rápida, diâmetro 775 mm. Carga máxima nas sapatas : 56 700 kg. Comandos de estabilização e indicador de nível instalados no interior da cabine.



Motor

Tier III : Motor a gasóleo Cummins QSB 6.7L, de seis cilindros turboalimentado, de 205 kW a 2 500 rpm. Binário máximo: 987 Nm a 1 500 rpm. Nota: Necessário para venda nos países fora da América do Norte e da União Europeia

Tier IV : Cummins QSB 6,7 L diesel, seis cilindros, turboalimentado, com silenciador/filtro de partículas diesel Cummins. Respeita os níveis de emissões de acordo com Tier IV da U.S.E.P.A. e classe IIIB da U.E. 205 KW a 2500 rpm. Binário máximo: 992 Nm a 1500 rpm. Requisitos relativos ao combustível: máximo de 15 ppm de teor de enxofre (diesel de muito baixo teor em enxofre). Nota: o motor Tier IV é necessário para venda nos países da América do Norte e da União Europeia. Depósito de 280 l



Transmissão

Gama completa com 6 velocidades para a frente e 6 de marcha atrás. Desembraiagem do eixo frontal para deslocação 4 x 2.



Tracção/direcção

4 x 4.

Direcção assistida de comando independente:

À frente : totalmente hidráulica, comandada pelo volante.

Atrás : totalmente hidráulica, comandada por interruptor.

Disponibiliza um número infinito de variações dos 4 principais modos de direcção: só dianteira, só traseira, direcção tipo caranguejo e direcção coordenada. Indicador de direcção traseira. Raio de viragem : 7,8 m.



EIXOS

Dianteiros : Eixo de tracção/direcção com cubos do redutor de planetários e diferencial rigidamente montados no chassis.

Traseiros : Eixo de tracção/direcção com cubos do redutor de planetários e diferencial montados no chassis de forma articulada (pivôs).



Pneus

Pneus standard 29,5 x 25 - 34 telas.



Travões

Travões de circuito dividido, totalmente hidráulicos, que actuam sobre todas as rodas. Travão de estacionamento de mola e de libertação hidráulica, montada no eixo dianteiro.



Iluminação

Conjunto completo, incluindo luzes de sinalização de mudança de direcção, faróis dianteiros, faróis traseiros, luzes de travagem e luzes de sinalização de perigo.



Velocidade máxima

35 km/h.



Sistema eléctrico

Duas baterias de 12 V que dispensam manutenção. Arranque e luzes de 12 V. Interruptor de desconexão da bateria. Sistema de diagnóstico CanBus.

* Equipamento opcional

- Conjunto de iluminação auxiliar (inclui luz intermitente âmbar montada na cabine, luz de trabalho montada no mecanismo de elevação e dois faróis de trabalho montados na base da lança).
- Barra de iluminação do LMI (na cabine).
- Bloqueio de oscilação mecânico estilo NYC de 360°.
- Gancho traseiro para corrente.
- Bloqueios do diferencial do eixo cruzado controlados na cabine (dianteiros e traseiros).
- Registador de dados PAT.
- Tapete de borracha para a caleira de armazenamento.

*Assinala o equipamento opcional

Технические характеристики

Крановая установка



Стрела

Пятисекционная, синхронизированная, телескопическая стрела длиной 11,4 – 43,2 м. Максимальная высота оголовка стрелы: 45,7 м.



*Фиксированный удлинитель стрелы

Складной решетчатый удлинитель стрелы (гидравлическое управление) на 10,0 - 17,0 м. Возможность установки под углом на 0°, 20° или 40°. Складывается вдоль секции основной стрелы. Максимальная высота оголовка удлинителя: 62,7 м.



*Промежуточные вставки удлинителя стрелы

2 решетчатых вставки длиной 4,8 м. Устанавливаются между оголовком стрелы и складным удлинителем. Не складываются. Максимальная высота оголовка удлинителя стрелы: 72,5 м.



Угол наклона стрелы

Один гидравлический цилиндр двойного действия со встроенным обратным клапаном обеспечивает подъем от -3° до +78°.



Ограничитель грузовой моменты и ограничитель высоты подъема крюка

Стандартный ограничитель грузовой моменты с графическим дисплеем и система блокировки при переподъеме с звуковой и визуальной сигнализацией и блокировкой органов управления. Эти системы выводят на электронный дисплей угол наклона стрелы, длину, радиус, высоту оголовка стрелы, относительный грузовой момент, максимально допустимую нагрузку, текущую нагрузку и предупреждение о возможности перегруза. Стандартная система ограничения рабочей зоны позволяет оператору заранее выбрать и определить безопасные рабочие зоны. При приближении крана к установленным границам срабатывает звуковая и визуальная сигнализация предупреждения оператора.



Кабина

Полностью стальная кабина с круговым обзором, звукоизоляцией и тонированными небьющимися стеклами по всему периметру. Наклон кабины до +20 градусов. Высококачественное сиденье оборудовано встроенными в подлокотники органами управления с одноосевым перемещением. Контрольные приборы для всех рабочих функций выведены на приборную панель. Остальные опции, включенные в стандартную поставку: обогреватель на горячей воде, вентилятор, раздвижные боковые и задние стекла, раздвижная застекленная крыша с электрическим стеклоочистителем и солнцезащитным экраном, электроомыватель и очиститель лобового стекла, огнетушитель и ремень безопасности. Воздушный кондиционер (28 500 БТЕ).



Поворот

Двухскоростной, привод механизма поворота через планетарный редуктор с жидкоохлаждаемым многодисковым тормозом. Пружинный, гидравлически отпускаемый тормоз механизма поворота. Механическая блокировка крановой установки в одном положении, выполняемая из кабины. Максимальная скорость: 2 об./мин.



Противовес

8 979 кг. Гидравлическая система монтажа.



Гидравлическая система

Два главных насоса ([1] поршневой и [1] шестеренчатый) с общей мощностью мощностью 503 л/с. Максимальное рабочее давление: 27,77 бар. Трехсекционная группа клапанов с компенсацией давления. Фильтр возвратной магистрали с полнопоточной обходной защитой и индикатором обслуживания. Сменный картридж, минимальный размер частиц, удаляемых фильтром - 5/12/16. Бак на 995 л. Устанавливаемый на опоре масляный радиатор с термостатом и вентиляторным охлаждением с приводом от гидравлического мотора. Контрольные отверстия для проверки давления системы.



Лебедка подъема

Планетарный редуктор с автоматическим пружинным многодисковым жидкоохлаждаемым тормозом. Электронные индикаторы вращения подъемного барабана и кабельные держатели. Максимальное натяжение каната при однократной запасовке: • 1 слой: 9 185 кг. • 3 слой: 7 716 кг. • 5 слой: 6 650 кг. Максимально допустимое натяжение каната: 7620 кг с канатом класса 6X37. 7620 кг с устойчивым к скручиванию канатом 35X7.

Максимальная скорость каната при однострунной оснастке: 156 м/мин. Конструкция каната: 6X36 с сердечником из высокопрочной стали для подъемных канатов особой гибкости, высокого качества. 35x7 Flex-X, устойчивый к скручиванию. Диаметр каната: 19 мм. Длина каната: Лебедка основного подъема: 183 м - Лебедка вспомогательного подъема: 183 м. Максимальная длина укладки каната: 256 м



CraneSTAR

Система управления ресурсом крана.

Тягач



Шасси

Коробчатая рама выполнена из высокопрочной низколегированной стали. Передние/задние буксировочные и крепежные проушины.



Выносные опоры

Четыре гидравлические телескопические одноступенчатые двухмуфтовые балочные выносные опоры с перевернутыми цилиндрами и встроенными блокирующими клапанами. 3 позиции выдвижения: 0%, 50% и на полную длину. Стальные, легко доступные опоры диаметром 775 мм. Максимальная нагрузка на подушку выносной опоры: 56 700 кг. Органы управления и указатель уровня крана расположены в кабине.



Двигатель

Tier III : Дизельный, 6-цилиндровый двигатель Cummins QSB объемом 6,7 л, мощность 205 кВт на 2 500 об./мин. Максимальный крутящий момент: 987 Нм при 1 500 об/мин. нормативное требование для продаж вне Европейского Союза и Северной Америки.

Tier IV : Дизельный Cummins QSB 6,7 л, 6-цилиндровый, с турбонагнетателем и выхлопным фильтром/шумоглушителем Cummins Diesel Particulate. Соответствует требованиям U.S.E.P.A. Tier IV и E.U. Stage III B, мощность 205 кВт при 2500 оборотов/мин. Максимальный крутящий момент: 992 Нм при 1500 оборотах/мин. Требования для горючего: максимальное содержание серы 15 частей на миллион (дизельное топливо с ультранизким содержанием серы) Примечание: двигатель Tier IV - нормативное требование для продаж в Европейском Союзе и Северной Америке. Емкость топливного бака: 280 л.



Трансмиссия

Полнофункциональный механизм переключения передач с 6 передними и 6 задними скоростями. Отключение переднего моста для передвижения в режиме 4 x 2.



Ведущие/управляемые колеса

4 x 4.

Полностью независимое рулевое управление с усилителем:

Передние: С полным гидравлическим усилением. Управление от рулевого колеса.

Задние: С полным гидравлическим усилением. Ручное управление с помощью переключателей.

Возможны многочисленные варианты 4 основных режимов рулевого управления: только передние, только задние, кравовый ход и согласованный режим. Индикатор заднего движения. Радиус разворота: 7,8 м.



Оси

Передняя: Ведущая с управляемыми колесами, с дифференциальными и планетарными колесными редукторами, жестко смонтированными на раму.

Задняя: Ведущая с управляемыми колесами, с дифференциальными и планетарными колесными редукторами, шарнирно закрепленными на раму.



Шины

Станд. 29,5 x 25 - 34 с диагональным кордом, общего применения.



Тормоза

Полностью гидравлические, раздельные на все колеса. Пружинный, гидравлически отпускаемый парковочный тормоз, закрепленный на передней оси.



Фары

Полное освещение, включая индикаторы поворота, передние, задние, тормозные фары и лампы аварийной сигнализации.



Максимальная скорость

35 км/ч.



Электросистема

Две, не требующие обслуживания, батареи на 12 В. Напряжение запуска и освещения - 12 В. Отключение батарей. Система диагностики CanBus.

* Дополнительное оборудование (по выбору)

- Дополнительный пакет освещения (фонарь желтого мигающего света в кабине, фонарь на лебедке и двойные прожекторы на основной стреле).
- Световая панель ограничителя грузовой моменты (в кабине).
- Механический фиксатор поворота типа NYC на 360°.
- Задний поворотный буксирный крюк.
- Механизм блокировки межколесного дифференциала, (передний и задний).
- Регистратор данных РАТ.
- Резиновый коврик на пол.

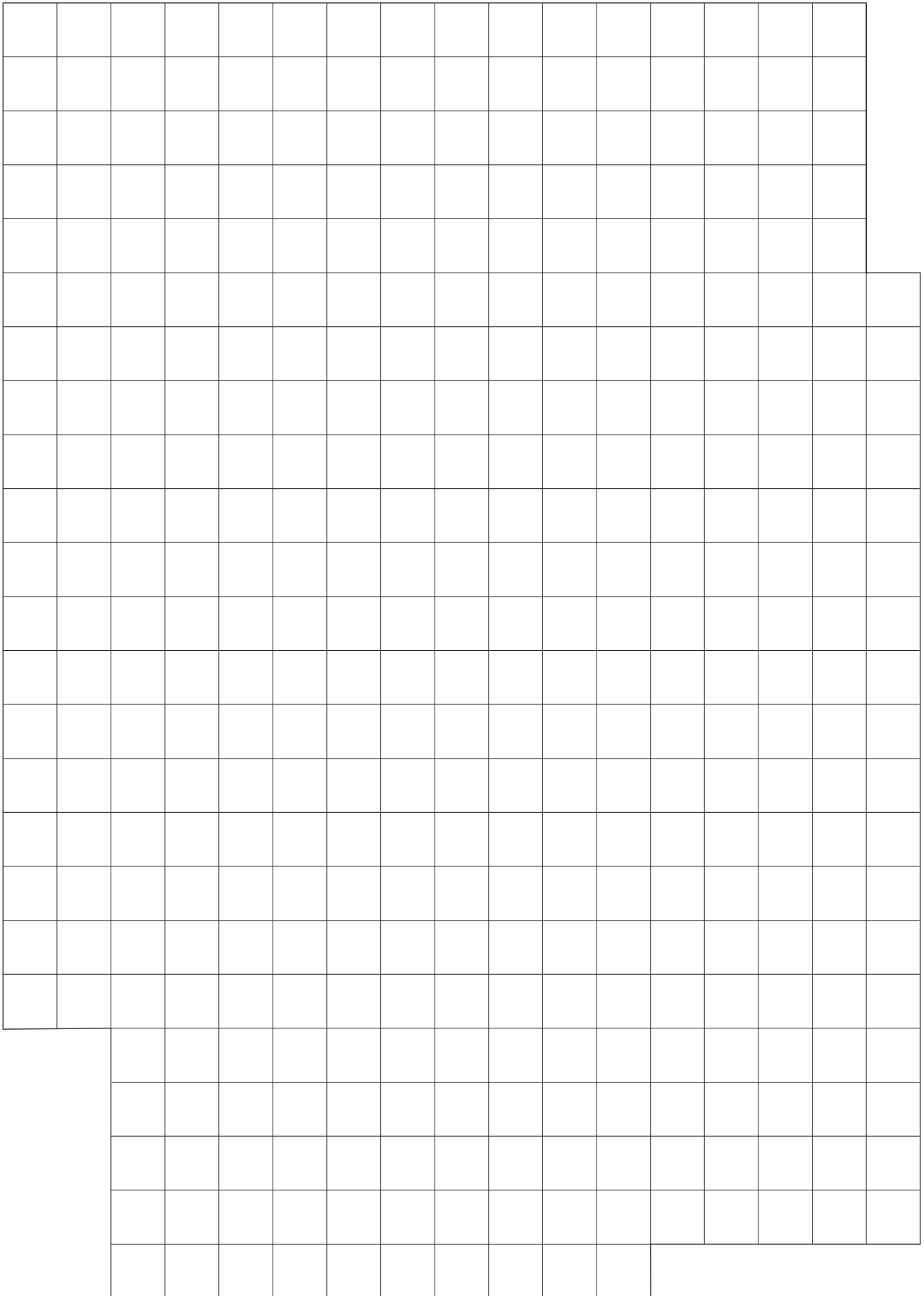

*Дополнительное оборудование

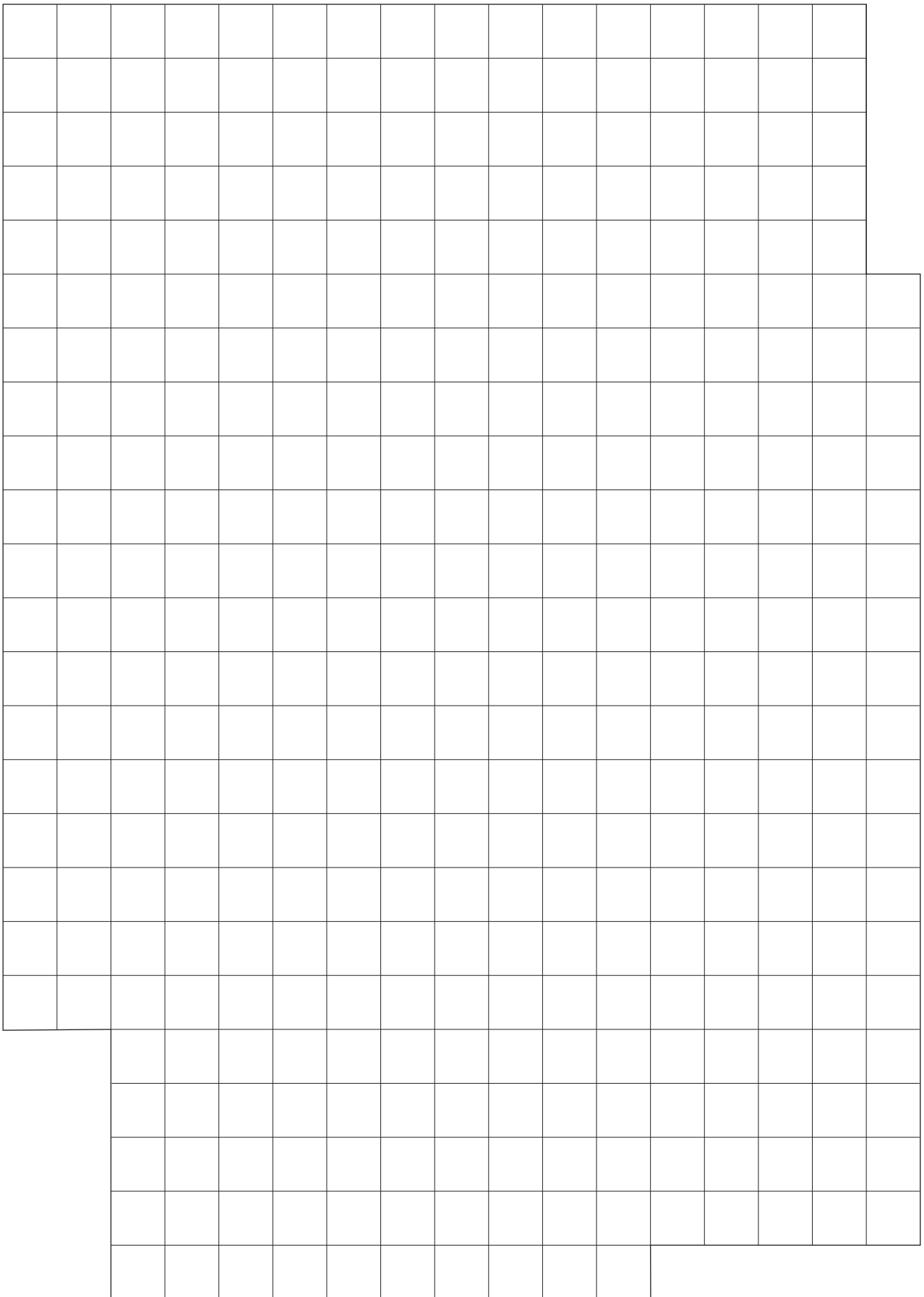



Notes • Hinweise • Notes • Notas • Note • Примечания

Symbols • Symbolerklärung • Glossaire des symboles • Glosario de simbolos • Glossario dei simboli • Simbolos • Символы

	Axles Achsen Ponts Ejes Assali Eixos Оси		Crane functions Kranbewegungen Mouvements de la grue Funciones de la grúa Funzioni della gru Funções da grua Функции крана		Hookblock / Capacity Hakenflasche / Traglast Moufle / Force de levage Gancho / Capacidad Gancio / Capacità Gancho / Capacidade Крюковой блок / Грузоподъемность		Speed Geschwindigkeit Vitesse Velocidad Velocità Velocidade СКОРОСТЬ
	Axle load Achslast Charge à l'essieu Carga por eje Carico sugli assi Carga por eixo Нагрузка на ось		Crane travel Fahrstellung Déplacement de la grue Grúa en traslado Traslazione gru Deslocação da grua Перемещение крана		Hydraulic system Hydrauliksystem Circuit hydraulique Sistema hidráulico Impianto idraulico Sistema hidráulico Гидравлическая система		Suspension Federung Suspension Suspensión Suspensio Suspensão Подвеска
	Boom Ausleger Flèche Pluma Braccio Lança Стрела		Drive/Steer Antrieb/Lenkung Direction/Déplacement Tracción/Dirección Trazione/Sterzo Tração / Direcção Ведущие/Управляемые оси		Lattice extension Gitterspitze Extension treillis Extensión de celosia Falcone tralicciato Extensão treliçada Гусек		Transmission / Gear Getriebe / Gang Boîte de vitesses / Rapport Transmisión / Cambio Cambio Transmissão / Mudança Трансмиссия / передача
	Boom elevation Wippwerk Relevage Elevacion de pluma Elevazione braccio Elevação da lança Подъем стрелы		Electrical system Elektrische Anlage Circuit électrique Sistema eléctrico Impianto elettrico Sistema eléctrico Электросистема		Lattice extension (luffing) Gitterspitze (wippbar) Extension treillis (volée variable) Extensión de celosia (angulable hidráulicamente) Falcone tralicciato (inclinabile) Extensão treliçada (angulação hidráulica) Гусек (с изменением вылета)		Travel speed Fahrgeschwindigkeit Vitesse de déplacement Velocidad de desplazamiento Velocità di traslazione Velocidade de translação СКОРОСТЬ ДВИЖЕНИЯ
	Boom telescoping Teleskopieren Télescopage de flèche Telescopaje de pluma Lunghezza braccio Telescopagem da lança Выдвижение стрелы		Engine Motor Moteur Motor Motore Motor Двигатель		Luffing Jib Wippspitzenausleger Volée variable Plumín angulable Falcone a volata variabile Jib angulável Маневровый гусек		Tyres Bereifung Pneumatiques Neumáticos Pneumatici Pneus Шины
	Brakes Bremsen Freins Frenos Freni Travões Тормоза		Free on wheels Freistehend Sur pneus Sobre neumáticos Su gomme - Sobre pneus Свободные внутренние колеса		Low range Kriechgang Gamme basse Marchas cortas Fuoristrada Marcha lenta Низкий диапазон		
	Cab Kabine Cabine Cabina Cabina Cabine Кабина		Gradeability Steigfähigkeit Aptitude en pente Superacion de pendientes Pendenza superabile Declive Преодолеваемый уклон		Outriggers Abstützung Calage Estabilizadores Stabilizzatori Estabilizadores Выносные опоры		
	Carrier frame Chassis-Rahmen Châssis porteur Bastidor Telaio Chassis Рама тягача		Main hoist Haupthubwerk Treuil principal Cabrestante principal Argano principale Guincho principal Лебедка основного подъема		Radius Ausladung Portée Radio Raggio Raio Вылет		
	Counterweight Gegengewicht Contrepoids Contrapeso Contrapeso - Contrapeso Противовес		Auxiliary hoist - Hilfshebwerk Treuil auxiliaire Cabrestante auxiliar Argano secundario Guincho auxiliar Лебедка вспомогательного подъема		Slewing/Working range Drehwerk/Arbeitsbereich Orientation/Rayon d'opération Giro/Gama de trabajo Rotazione/Area di lavoro - Giratória / Gama de trabalho Поворот/ Рабочий диапазон		

Manitowoc Cranes

Regional headquarters

Americas

Manitowoc, Wisconsin, USA

Tel: +1 920 684 6621

Fax: +1 920 683 6277

Shady Grove, Pennsylvania, USA

Tel: +1 717 597 8121

Fax: +1 717 597 4062

Europe, Middle East, Africa

Dardilly, France

Tel: +33 (0)4 72 18 20 20

Fax: +33 (0)4 72 18 20 00

China

Shanghai, China

Tel: +86 21 6457 0066

Fax: +86 21 6457 4955

Greater Asia-Pacific

Singapore

Tel: +65 6264 1188

Fax: +65 6862 4040

Regional offices

Americas

Brazil

Alphaville

Mexico

Monterrey

Chile

Santiago

Europe, Middle East,

Africa

France

Baudemont

Cergy

Decines

Germany

Langenfeld

Italy

Lainate

Netherlands

Breda

Poland

Warsaw

Portugal

Baltar

Russia

Moscow

South Africa

Johannesburg

U.A.E.

Dubai

U.K.

Buckingham

China

Beijing

Chengdu

Guangzhou

Xian

Greater Asia-Pacific

Australia

Brisbane

Melbourne

Sydney

India

Chennai

Delhi

Hyderabad

Pune

Korea

Seoul

Philippines

Makati City

Singapore

Factories

Brazil

Passo Fundo

China

TaiAn

Zhangjiagang

France

Charlieu

Moulines

Germany

Wilhelmshaven

India

Pune

Italy

Niella Tanaro

Portugal

Baltar

Fânzeres

USA

Manitowoc

Port Washington

Shady Grove

This document is non-contractual. Constant improvement and engineering progress make it necessary that we reserve the right to make specification, equipment, and price changes without notice. Illustrations shown may include optional equipment and accessories and may not include all standard equipment.

Die Angaben in diesem Dokument erfolgen ohne Gewähr. Wir verbessern unsere Produkte ständig und integrieren den technischen Fortschritt. Aus diesem Grund behalten wir uns das Recht vor, die technischen Daten, die Ausstattungsdetails und die Preise unserer Maschinen ohne Vorankündigung zu ändern.

Ce document est non-contractuel. Du fait de sa politique d'amélioration constante de ses produits liée au progrès technique, la Société se réserve le droit de procéder sans préavis à des changements de spécifications, d'équipement ou de prix. Les illustrations peuvent comporter des équipements ou accessoires optionnels ou ne pas comporter des équipements standards.

Este documento no es contractual. El perfeccionamiento constante y el avance tecnológico hacen necesario que la empresa se reserve el derecho de efectuar cambios en las especificaciones, equipo y precios sin previo aviso. En las ilustraciones se puede incluir equipo y accesorios opcionales y es posible que no se muestre el equipo normal.

Documento non contrattuale. In considerazione della sua politica di costante miglioramento dei prodotti connesso al progresso tecnico, la Società si riserva il diritto di modificare senza preavviso specifiche, equipaggiamenti o prezzi. Le illustrazioni possono contenere equipaggiamenti o accessori optional o non contenere equipaggiamenti standard.

Este documento não se reveste de qualquer carácter contratual. A introdução constante de melhorias e o progresso da engenharia tornam necessário reservarmos o direito de introduzir alterações nas características técnicas, no equipamento e no preço sem qualquer aviso prévio. As ilustrações aqui apresentadas podem incluir equipamento e acessórios adicionais, podendo não incluir todo o equipamento padrão.

Данный документ не является контрактным. Принимая во внимание необходимость постоянного совершенствования и модернизации мы оставляем за собой право изменять спецификации, конструкции и стоимость без предварительного уведомления. Приведенные иллюстрации могут содержать дополнительные компоненты и принадлежности, не входящие в стандартный комплект поставки оборудования.