

MDT 389 L12

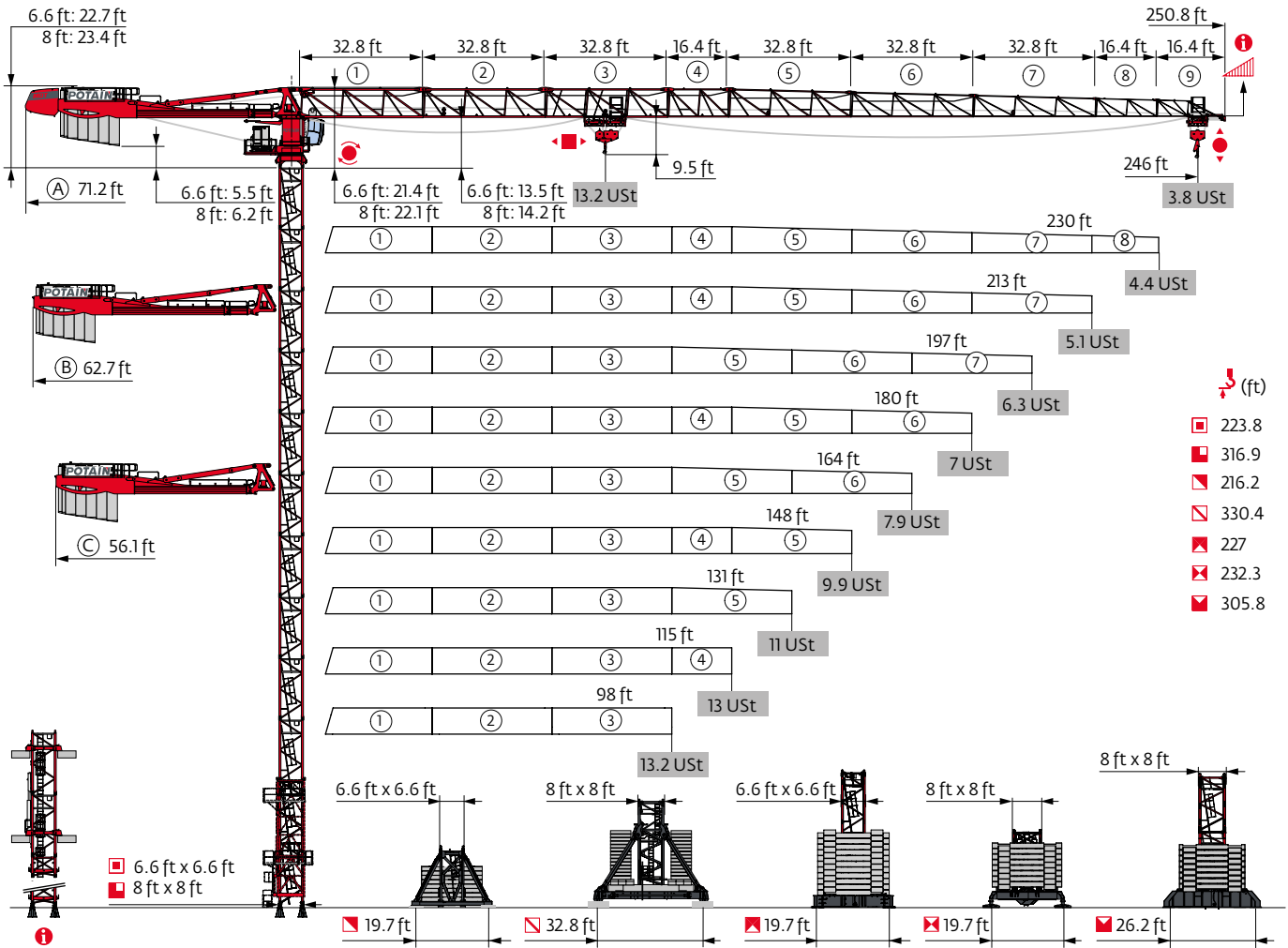

- ↓ (ft)
- ▣ 223.8
 - ▣ 316.9
 - ▣ 216.2
 - ▣ 330.4
 - ▣ 227
 - ▣ 232.3
 - ▣ 305.8

Potain Plus Power Control Top Site Anti-collision systems Automatic Rotation Control

P+

kVA

POTAIN
CONNECT

ARC

Mast - Reactions

6.6 ft - P 63A

Height (ft)	98	115	131	148	164	180	197	213	230	246
Height (ft)	223.8	223.8	223.8	218.5	218.5	218.5	218.5	218.5	212.9	212.9
Height/P _r (ft)	223.8	202.1	202.1	207.4	218.5	207.4	218.5	218.5	212.9	212.9
10.9 ft	2	2	2	0	0	0	0	0	1	1
16.4 ft	10	10	10	11	11	11	11	11	10	10
32.8 ft	1	1	1	1	1	1	1	1	1	1
F2 (Ust)	● 219 ■ 287	228 293	227 293	223 274	230 282	224 283	224 287	228 295	230 289	232 296
F3 (Ust)	● 155 ■ 230	161 233	159 232	154 211	160 218	155 220	155 224	157 230	159 224	161 232

6.6 ft - V 60A

Height (ft)	98	115	131	148	164	180	197	213	230	246
Height (ft)	216.2	216.2	216.2	216.2	216.2	216.2	210.6	205	205	205
Height/P _r (ft)	216.2	199.8	199.8	199.8	216.2	199.8	210.6	205	205	205
10.9 ft	0	0	0	0	0	0	1	2	2	2
16.4 ft	12	12	12	12	12	12	11	10	10	10
F1 (Ust)	● 123 ■ 130	126 132	122 132	123 129	125 133	123 134	121 129	124 127	125 133	126 137

6.6 ft - ZX 640

Height (ft)	98	115	131	148	164	180	197	213	230	246
Height (ft)	227	227	227	221.5	221.5	221.5	221.5	221.5	216.2	216.2
Height/P _r (ft)	227	205.1	205.1	205.1	221.5	205.1	221.5	221.5	216.2	216.2
10.9 ft	2	2	2	0	0	0	0	0	1	1
16.4 ft	10	10	10	11	11	11	11	11	10	10
32.8 ft	1	1	1	1	1	1	1	1	1	1
F1 (Ust)	● 133 ■ 146	134 149	134 149	133 139	136 142	134 143	134 145	136 150	136 146	137 151

8 ft - P 800B

Height (ft)	98	115	131	148	164	180	197	213	230	246
Height (ft)	267.7	267.7	267.7	262.1	262.1	262.1	262.1	251.3	251.3	251.3
Height/P _r (ft)	267.7	267.7	267.7	262.1	262.1	262.1	262.1	251.3	251.3	251.3
10.9 ft	0	0	0	1	1	1	1	0	0	0
16.4 ft	16	16	16	15	15	15	15	15	15	15
F2 (Ust)	● 233 ■ 398	244 402	243 403	239 388	237 394	238 395	232 398	233 370	235 378	237 385
F3 (Ust)	● 152 ■ 324	161 326	159 325	153 309	151 315	152 316	147 319	148 291	149 299	151 305

8 ft - P 854A

Height (ft)	98	115	131	148	164	180	197	213	230	246
Height (ft)	316.9	316.9	316.9	316.9	316.9	316.9	316.9	316.9	311.4	305.8
Height/P _r (ft)	316.9	316.9	316.9	316.9	316.9	316.9	316.9	316.9	311.4	305.8
10.9 ft	0	0	0	0	0	0	0	0	1	2
16.4 ft	19	19	19	19	19	19	19	19	18	17
F2 (Ust)	● 290 ■ 574	301 579	300 580	299 577	298 583	299 585	293 586	308 597	305 589	302 581
F3 (Ust)	● 199 ■ 489	205 490	203 489	201 485	200 492	199 492	196 496	208 504	206 496	203 489

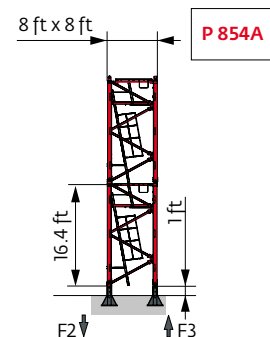
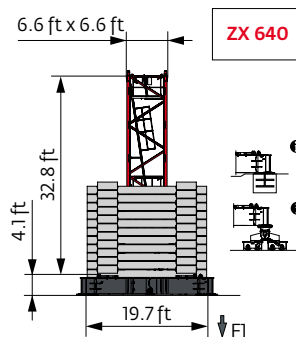
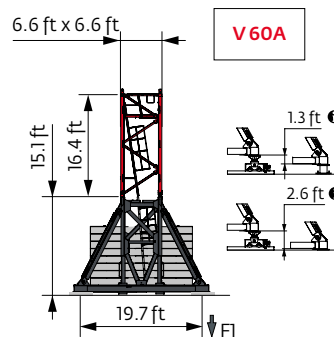
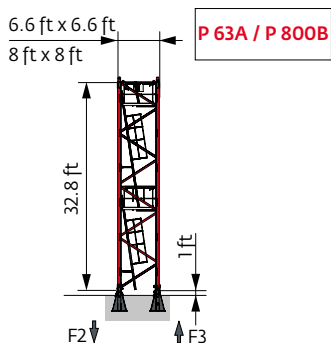

8 ft - JM 850

Height (ft)	98	115	131	148	164	180	197	213	230	246
Height (ft)	330.4	330.4	330.4	330.4	330.4	324.8	324.8	319.2	319.2	314
Height/P _r (ft)	330.4	330.4	330.4	330.4	330.4	324.8	324.8	319.2	319.2	314
10.9 ft	0	0	0	0	0	1	1	2	2	0
16.4 ft	18	18	18	18	18	17	17	16	16	17
FI (Ust)	● 161	166	166	166	166	162	160	162	163	154
	■ 252	253	253	252	255	249	250	247	251	233

8 ft - ZX 6830

Height (ft)	98	115	131	148	164	180	197	213	230	246
Height (ft)	232.3	232.3	232.3	232.3	232.3	232.3	227	227	221.5	221.5
Height/P _r (ft)	232.3	232.3	232.3	232.3	232.3	232.3	227	227	221.5	221.5
10.9 ft	1	1	1	1	1	1	2	2	0	0
16.4 ft	13	13	13	13	13	13	12	12	13	13
FI (Ust)	● 142	147	147	145	147	148	141	146	143	144
	■ 188	190	189	186	191	192	186	191	183	188

8 ft - ZY 800

Height (ft)	98	115	131	148	164	180	197	213	230	246
Height (ft)	255.6	255.6	255.6	255.6	255.6	255.6	255.6	244.8	244.8	244.8
Height/P _r (ft)	255.6	255.6	255.6	255.6	255.6	255.6	255.6	244.8	244.8	244.8
10.9 ft	0	0	0	0	0	0	0	2	2	2
16.4 ft	15	15	15	15	15	15	15	13	13	13
FI (Ust)	● 136	141	138	139	139	139	141	135	139	140
	■ 187	188	188	186	192	192	195	185	191	196

8 ft - ZY 854

Height (ft)	98	115	131	148	164	180	197	213	230	246
Height (ft)	305.8	305.8	305.8	305.8	305.8	305.8	305.8	305.8	300.2	295
Height/P _r (ft)	305.8	305.8	305.8	305.8	305.8	305.8	305.8	305.8	300.2	295
10.9 ft	0	0	0	0	0	0	0	0	1	2
16.4 ft	18	18	18	18	18	18	18	18	17	16
FI (Ust)	● 188	192	192	190	193	193	192	198	197	192
	■ 284	283	283	282	288	289	294	298	297	292

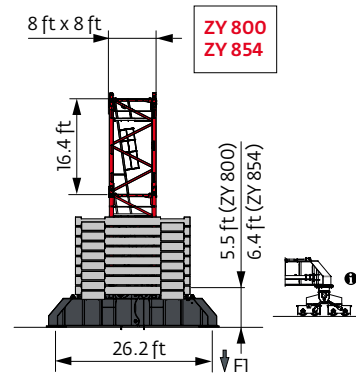
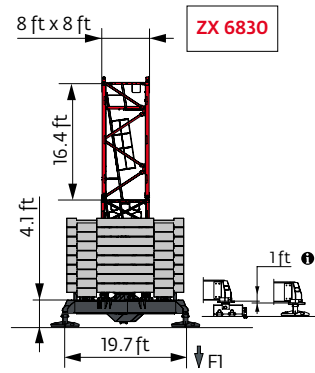
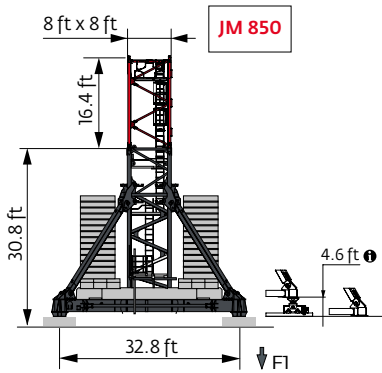

Note: When "ASCE" is noted in this data sheet it is referring to 115 mph Wind Zone, Exposure B, Design Wind Speed = 98 mph. See back cover for design wind speed calculations.

i Motorized accesses: adapted mast compositions, base ballast and reactions.

Other mast compositions - Please consult us

Anchorage

i

Base ballast

Ust) / 6.6 ft - V 60A -

Ust) / 6.6 ft - V 60A -	98	115	131	148	164	180	197	213	230	246
216.2	132.3	132.3	119.1	119.1	119.1	119.1				
210.6	132.3	119.1	119.1	119.1	119.1	119.1	119.1			
205	119.1	119.1	119.1	119.1	105.8	105.8	105.8	119.1	119.1	119.1
188.6	105.8	105.8	105.8	105.8	92.6	105.8	92.6	105.8	105.8	105.8
172.2	92.6	105.8	105.8	105.8	92.6	92.6	79.4	92.6	79.4	79.4
155.8	79.4	105.8	92.6	92.6	79.4	92.6	66.1	66.1	66.1	66.1
139.4	66.1	92.6	92.6	92.6	79.4	79.4	52.9	52.9	52.9	66.1
123	66.1	92.6	92.6	92.6	79.4	79.4	52.9	52.9	52.9	52.9

Ust) / 6.6 ft - ZX 640 -

Ust) / 6.6 ft - ZX 640 -	98	115	131	148	164	180	197	213	230	246
227	154.3	143.3	143.3							
221.5	143.3	143.3	143.3	143.3	143.3	143.3	143.3	143.3		
216.2	143.3	132.3	132.3	132.3	132.3	132.3	132.3	132.3	143.3	143.3
199.8	121.3	121.3	121.3	121.3	121.3	110.2	121.3	110.2	121.3	121.3
183.4	99.2	110.2	110.2	110.2	99.2	99.2	99.2	99.2	99.2	99.2
167	88.2	110.2	110.2	99.2	88.2	99.2	77.2	77.2	88.2	88.2
150.6	66.1	99.2	99.2	99.2	77.2	88.2	66.1	66.1	66.1	66.1
134.2	55.1	99.2	88.2	88.2	66.1	77.2	55.1	55.1	55.1	55.1
117.8	55.1	88.2	88.2	88.2	66.1	77.2	55.1	55.1	44.1	55.1

Ust) / 8 ft - JM 850 -

Ust) / 8 ft - JM 850 -	98	115	131	148	164	180	197	213	230	246
330.4	198.4	198.4	198.4	198.4	198.4					
324.8	198.4	198.4	185.2	185.2	185.2	185.2	185.2			
319.2	185.2	185.2	185.2	172	185.2	172	185.2	185.2	185.2	
314	158.7	158.7	145.5	145.5	145.5	145.5	145.5	145.5	158.7	158.7
297.6	132.3	132.3	119.1	119.1	119.1	119.1	119.1	119.1	132.3	132.3
281.2	105.8	92.6	92.6	92.6	92.6	92.6	92.6	92.6	105.8	105.8
264.8	79.4	79.4	66.1	66.1	66.1	66.1	66.1	66.1	79.4	79.4
248.4 ↓	52.9	52.9	52.9	52.9	52.9	52.9	52.9	52.9	52.9	52.9
133.5	52.9	52.9	52.9	52.9	52.9	52.9	52.9	52.9	52.9	52.9

Ust) / 8 ft - ZX 6830 -

Ust) / 8 ft - ZX 6830 -	98	115	131	148	164	180	197	213	230	246
232.3	166.5	166.5	166.5	155.4	166.5	166.5				
227	155.4	155.4	155.4	144.4	155.4	155.4	155.4	155.4		
221.5	144.4	144.4	144.4	133.4	133.4	133.4	144.4	144.4	155.4	155.4
205.1	122.4	122.4	122.4	122.4	111.3	111.3	111.3	122.4	122.4	122.4
188.7	111.3	100.3	100.3	100.3	100.3	100.3	89.3	100.3	100.3	100.3
172.2	89.3	89.3	89.3	89.3	78.3	78.3	78.3	89.3	89.3	78.3
155.8	67.2	89.3	89.3	89.3	67.2	78.3	56.2	67.2	67.2	67.2
139.4	56.2	89.3	89.3	89.3	67.2	78.3	56.2	56.2	45.2	56.2

Ust) / 8 ft - ZY 800 -

Ust) / 8 ft - ZY 800 -	98	115	131	148	164	180	197	213	230	246
255.6	132.3	132.3	119.1	119.1	119.1	119.1	132.3			
244.8	105.8	105.8	105.8	105.8	105.8	105.8	105.8	105.8	119.1	119.1
228.4	79.4	79.4	79.4	66.1	79.4	79.4	79.4	79.4	79.4	92.6
211.9	66.1	52.9	52.9	52.9	52.9	52.9	52.9	52.9	52.9	66.1
195.5	52.9	52.9	39.7	39.7	39.7	39.7	39.7	39.7	39.7	39.7
179.1	39.7	39.7	39.7	26.5	26.5	26.5	26.5	26.5	26.5	26.5
162.7	26.5	39.7	26.5	26.5	13.2	13.2	13.2	13.2	13.2	13.2
146.3	13.2	39.7	26.5	26.5	13.2	13.2	13.2	13.2	13.2	13.2
129.9	13.2	39.7	26.5	26.5	13.2	13.2	13.2	13.2	13.2	13.2

Ust) / 8 ft - ZY 854 -

Ust) / 8 ft - ZY 854 -	98	115	131	148	164	180	197	213	230	246
305.8	238.1	238.1	238.1	224.9	238.1	238.1	238.1	238.1		
300.2	224.9	224.9	224.9	211.6	224.9	224.9	224.9	224.9	238.1	
295	211.6	211.6	211.6	198.4	211.6	211.6	211.6	224.9	224.9	224.9
278.5	172	172	172	158.7	172	172	172	172	185.2	185.2
262.1	132.3	132.3	132.3	119.1	132.3	132.3	132.3	132.3	145.5	145.5
245.7	105.8	105.8	105.8	92.6	92.6	92.6	92.6	105.8	105.8	119.1
229.3	66.1	66.1	66.1	66.1	66.1	66.1	66.1	66.1	79.4	79.4
212.9	52.9	52.9	39.7	39.7	39.7	39.7	39.7	52.9	52.9	52.9
196.5	39.7	39.7	26.5	26.5	26.5	26.5	26.5	39.7	39.7	39.7
180.1	26.5	26.5	26.5	26.5	13.2	13.2	13.2	26.5	13.2	13.2
163.7 ↓	13.2	26.5	13.2	13.2	13.2	13.2	13.2	13.2	13.2	13.2
130.9	13.2	26.5	13.2	13.2	13.2	13.2	13.2	13.2	13.2	13.2

Load curves



		(ft)		72	89	98	105	115	121	131	138	148	154	164	171	180	187	197	203	213	220	230	236	246	ft	
		13.2 USt	6.6 USt																							
246	10 → 82	143 - 156		13.2	12.2	10.8	10	9	8.4	7.5	7	6.6	6.6	6.1	5.8	5.4	5.1	4.8	4.5	4.3	4.1	3.9	3.7	3.6	USt	
	10 → 86	147 - 159		13.2	12.8	11.3	10.3	9.2	8.5	7.7	7.2	6.6	6.6	6.4	6.1	5.7	5.4	5	4.8	4.5	4.3	4.1	3.9	3.8	USt P+	
230	10 → 87	151 - 163		13.2	12.9	11.5	10.7	9.6	8.9	8.1	7.5	6.8	6.6	6.5	6.2	5.7	5.5	5.1	4.9	4.6	4.4	4.2			USt	
	10 → 90	154 - 168		13.2	13.2	11.9	11	9.8	9.1	8.2	7.7	7	6.6	6.6	6.5	6	5.7	5.4	5.1	4.8	4.6	4.4			USt P+	
213	10 → 93	158 - 170		13.2	13.2	12.4	11.5	10.3	9.5	8.6	8	7.3	6.8	6.6	6.5	6.1	5.8	5.4	5.2	4.9					USt	
	10 → 95	161 - 174		13.2	13.2	12.7	11.6	10.3	9.6	8.7	8.1	7.4	7	6.6	6.6	6.4	6.1	5.7	5.4	5.1					USt P+	
197	10 → 95	172 - 185		13.2	13.2	12.7	11.8	10.7	10	9.1	8.6	8	7.6	7	6.7	6.6	6.5	6.2							USt	
	10 → 97	175 - 188		13.2	13.2	13	12.1	10.9	10.2	9.3	8.8	8.1	7.7	7.1	6.8	6.6	6.6	6.3							USt P+	
180	10 → 100			13.2	13.2	13.2	12.5	11.3	10.6	9.7	9.2	8.5	8.1	7.5	7.2	6.7									USt	
	10 → 108			13.2	13.2	13.2	13.2	12.3	11.4	10.4	9.7	8.9	8.4	7.8	7.4	6.9									USt P+	
164	10 → 100			13.2	13.2	13.2	12.5	11.3	10.7	9.8	9.2	8.5	8.1	7.6											USt	
	10 → 105			13.2	13.2	13.2	13.2	11.9	11.2	10.2	9.7	8.9	8.5	7.9											USt P+	
148	10 → 104			13.2	13.2	13.2	13.1	11.9	11.2	10.2	9.7	9													USt	
	10 → 114			13.2	13.2	13.2	13.2	13.1	12.3	11.3	10.7	9.9													USt P+	
131	10 → 102			13.2	13.2	13.2	12.9	11.6	10.9	10															USt	
	10 → 111			13.2	13.2	13.2	13.2	12.8	12	11															USt P+	
115	10 → 103			13.2	13.2	13.2	13	11.7																		USt
	10 → 112			13.2	13.2	13.2	13.2	12.9																		USt P+
98	10 → 98			13.2	13.2	13.2																				USt
	10 → 98			13.2	13.2	13.2																				USt P+

$U_{L2} = U_{L1} - 0.74 \text{ USt max.}$



		(ft)		72	89	98	105	115	121	131	138	148	154	164	171	180	187	197	203	213	220	230	236	246	ft	
		13.2 USt	6.6 USt																							
246	8 → 82	144 - 148		13.2	12.2	10.9	10.1	9.1	8.4	7.6	7.1	6.6	6.2	5.6	5.3	4.9	4.6	4.3	4.1	3.8	3.6	3.4	3.3	3.1	USt	
	8 → 86	148 - 150		13.2	12.9	11.3	10.4	9.3	8.6	7.8	7.2	6.6	6.4	5.9	5.6	5.2	4.9	4.6	4.3	4.1	3.9	3.6	3.5	3.3	USt P+	
230	8 → 87	152 - 154		13.2	13	11.5	10.7	9.7	9	8.1	7.6	6.9	6.6	6.1	5.7	5.3	5	4.6	4.4	4.1	4	3.7			USt	
	8 → 90	155 - 158		13.2	13.2	12	11	9.9	9.1	8.3	7.7	7.1	6.7	6.3	6	5.6	5.3	4.9	4.7	4.4	4.2	4			USt P+	
213	8 → 93	159 - 161		13.2	13.2	12.4	11.5	10.3	9.6	8.6	8	7.3	6.9	6.5	6.1	5.7	5.4	5	4.8	4.5					USt	
	8 → 95	163 - 165		13.2	13.2	12.7	11.6	10.4	9.6	8.7	8.2	7.5	7.1	6.6	6.4	6	5.7	5.3	5	4.8					USt P+	
197	8 → 96	173 - 177		13.2	13.2	12.8	11.9	10.7	10.1	9.2	8.7	8	7.6	7.1	6.7	6.5	6.2	5.8							USt	
	8 → 97	176 - 180		13.2	13.2	13	12.1	10.9	10.3	9.4	8.9	8.2	7.8	7.2	6.9	6.6	6.3	6							USt P+	
180	8 → 100			13.2	13.2	13.2	12.6	11.4	10.7	9.8	9.3	8.6	8.2	7.6	7.3	6.8									USt	
	8 → 109			13.2	13.2	13.2	13.2	12.3	11.5	10.4	9.8	9	8.5	7.9	7.5	7									USt P+	
164	8 → 100			13.2	13.2	13.2	12.6	11.4	10.7	9.8	9.3	8.6	8.2	7.6											USt	
	8 → 105			13.2	13.2	13.2	13.2	12	11.3	10.3	9.7	9	8.5	7.9											USt P+	
148	8 → 105			13.2	13.2	13.2	13.2	12	11.2	10.3	9.8	9													USt	
	8 → 114			13.2	13.2	13.2	13.2	13.1	12.4	11.3	10.7	9.9													USt P+	
131	8 → 103			13.2	13.2	13.2	12.9	11.7	11	10															USt	
	8 → 112			13.2	13.2	13.2	13.2	12.9	12.1	11															USt P+	
115	8 → 104			13.2	13.2	13.2	13.1	11.8																		USt
	8 → 113			13.2	13.2	13.2	13.2	13																		USt P+
98	8 → 98			13.2	13.2	13.2																				USt
	8 → 98			13.2	13.2	13.2																				USt P+

$U_{L2} = U_{L1} - 0.2 \text{ USt max.}$

Jib weight & counter-jib ballast

Height (ft)	Jib Weight (lb) (+/- 5%)			CBS-10,141 lb			CBS-3,373 lb		
	Windward	Leeward	Windward	Windward	Leeward	Windward	Windward	Leeward	Windward
246 ft	39,840	38,964	39,996	5	2	57,452	8	1	57,519
230 ft	39,253	38,411	39,388	5	2	57,452	8	1	57,519
213 ft	38,402	37,626	38,603	5	2	57,452	8	1	57,519
197 ft	36,363	35,653	36,520	5	1	54,079	8	0	54,146
180 ft	36,387	35,677	36,544	5	1	54,079	8	0	54,146
164 ft	34,595	33,885	34,751	5	2	57,452	8	1	57,519
148 ft	34,013	33,303	34,169	5	2	57,452	8	1	57,519
131 ft	32,221	31,511	32,377	5	0	50,706	7	1	50,750
115 ft	31,052	30,342	31,209	4	2	47,311	7	0	47,377
98 ft	29,205	28,495	29,361	4	1	43,938	6	1	43,982

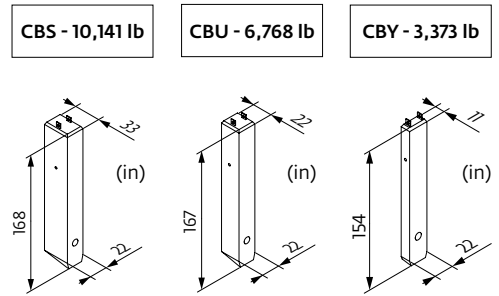





Dimensions and weight

Slewing crane part:  246 ft -  -  90 HPL™

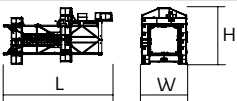

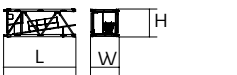
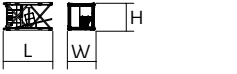
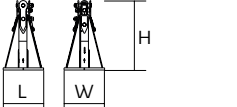
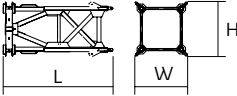
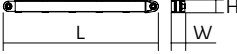
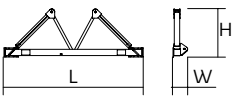
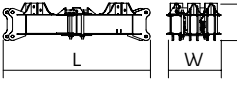
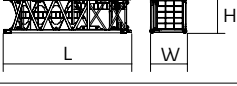
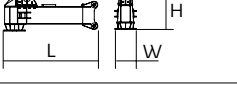
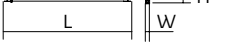
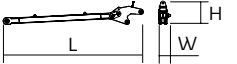
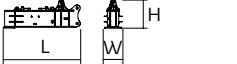
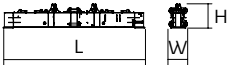
Slewing crane part			L (ft)	W (ft)	H (ft)	lb (+/- 5%)	
Counter-jib		Ⓐ	39.4	4.1	8.2	31,107	
			Ⓑ	39.4	4.1	8.2	29,983
			Ⓒ	39.4	4.1	8.2	25,441
Cab mast + cab		Ultra View	16.5	7.3	8.2	14,815	
Towerhead			6.6 ft	9.7	8.1	16,799	
			8 ft	10.7	8.2	9	19,180
Hoisting winch (+ rope)		90 HPL™	14	7.5	7.6	9,921	
Jib section		① 6 DVF	35.3	5.9	9	12,015	
Jib section		② ③ ⑤ ⑥ ⑦	33.5	3.9	8.2	6,934	
			33.8	3.9	7.9	5,335	
			33.5	3.9	7.8	3,439	
			33.6	3.9	6.9	2,723	
			33.4	3.9	6	2,094	
Jib section		④ ⑧ ⑨	17.3	3.9	7.8	2,116	
			16.7	3.9	5	683	
			16.7	3.9	4.6	485	
Trolley			6.1	5	3.4	882	
Pulley block			3.9	1.4	7.6	1,003	
Trolley			5.2	5	3.2	463	
Trolley			5.6	5	3.4	540	
				6.1	5	3.2	520
Pulley block			5.4	0.7	5.8	992	
				3.6	0.9	5.3	584

Crane tower			L (ft)	W (ft)	H (ft)	lb (+/- 5%)
Telescopic cage T 61 Telescopic cage T 851		□ 6.6 ft □ 8 ft	35.5 36.7	13.6 15.9	14.7 19	21,385 34,723
K 649B KM 649E KRM 6410B KRM 849B K 85/KR 84B2 KM 850.10B KM 850.14B		□ 6.6 ft □ 6.6 ft □ 6.6 ft □ 8 ft □ 8 ft □ 8 ft □ 8 ft	33.6 33.8 33.6 33.6 33.6 33.9 33.9	6.8 6.7 6.9 8.4 8.3 8.3 8.3	6.7 6.7 6.8 8.3 8.2 8.2 8.2	11,663 10,692 15,653 17,196 21,242 22,201 24,670
K 649A KMT 649A KR 649A KRMT 649A K 849A KMT 849A KR 849A KRMT 849A K 85/KR 84A2 KMT 850.10A KMT 850.14A		□ 6.6 ft □ 6.6 ft □ 6.6 ft □ 6.6 ft □ 8 ft □ 8 ft □ 8 ft □ 8 ft □ 8 ft □ 8 ft □ 8 ft □ 8 ft	17.2 17.2 17.2 17.2 17.2 17.2 17.2 17.2 17.2 17.2 17.5 17.5	6.8 6.8 6.9 6.9 8.3 8.4 8.3 8.3 8.3 8.3 8.3 8.3	6.7 6.7 6.8 6.8 8.2 8.3 8.2 8.3 8.2 8.2 8.2 8.2	6,184 5,666 7,165 6,724 7,496 6,945 9,458 9,017 12,236 12,015 13,206
KRMT 649C KRMT 849C		□ 6.6 ft □ 8 ft	11.7 11.7	6.9 8.4	6.8 8.3	5,401 7,066
Fixing angles		P 63A / P 800B P 854A	2.5 3	2.5 3	4.2 4.9	1,025 2,072
Basic mast unit		V 60A	16.4	7.9	7.9	10,494
Struts		V 60A	14.8	1	1	1,036
Half-bearer		V 60A	22	2.3	7.6	4,057
Central cross (transport position)		JM 850	17.1	5.6	4.9	14,771
Basic mast unit		JM 850	28.7	8.2	8.2	32,187
Chassis girder		JM 850	17.1	3	5.1	7,055
Chassis ties		JM 850	23.6	0.8	1.1	551
Struts		JM 850	26.9	2.5	4.3	5,071
1/2 Cross girder		ZX 640 ZY 800 ZY 854	14.3 18.6 18.7	3.3 3.2 3.2	5.1 6.3 7.4	7,319 10,406 14,176
Cross girder		ZX 640 ZY 800 ZY 854	30 39.2 39	3.9 4.6 4.7	5.1 6.3 7.4	15,168 22,212 30,865
		ZX 6830	29.9 29.9	3.7 2.5	3.6 4.9	11,607 12,004

Mechanisms

480 V - 60 Hz													hp	kW	
	90 HPL™ 30	fpm USt	176 6.6	228 5	326 3.3	469 1.7	723 0.2	90 13.2	120 9.9	172 6.6	244 3.3	361 0.9	90	66	2,772 ft
	6 DVF 6 Optima	fpm	0 → 138 (13.2 USt) 0 → 276 (8.8 USt) 0 → 328 (4.4 USt)									5.5	4		
	RVF 172 Optima+	rpm	0 → 0.9									2 x 10	2 x 7.5		

480 V(+6% -10%) 60 Hz	96 → 60 kVA	

These most combinations meet the EN 14439 and ASME B30.3-2016 specifications for “out of service” wind conditions, provided the illustrated wind speed matches required design wind speed for the location of the tower crane. The “out of service” design wind speed was determined in accordance with ASCE 7-10, Figure 26.5-1A. The wind velocity, used for this configuration was 98 mph (158 kph), which represents a nominal design 3-second wind gust at 33 ft (10 m) above ground for Exposure B category. A factor of 0.85 was applied to the 700-year ultimate design wind speed of 115 mph (185 kph), per ASCE 37-02, with the assumption that this crane is considered a temporary structure used during a construction period of 2 years or less.

- Jib elevation
- Standard equipment
- Options
- Potain Plus function: Plus load curves
- Hook heights with Plus load curves
- Reactions in service
- Reactions out of service
- Total ballast weight
- Jib weight
- Lorry 44 ft
- Container High Cube 40 ft, and/or Flat Rack 20 ft
- Hoisting
- Trolleying
- Slewing
- Travelling
- Required power
- Power Control Function: winch speeds adapted to the available power
- Consult us

This commercial document is not legally binding. For any technical information, please refer to the corresponding instructions.

