

Liftcrane Boom Capacities With Luffing Jib Attached

Boom No. B60:500

Luffing Jib No. LJ10:501

with Mast No. M10:503 or Mast No. M11:503

175 100 kg VPC (Variable Position Counterweight)

360 Degree Rating

MLC300 VPC-MAX SERIES 2

 **LIFTING CAPACITIES:** Lifting capacities for various boom lengths, luffing jib lengths, boom-to-luffing jib angles, and boom operating radii are for freely suspended loads and may be based on percent of static tipping or strength of structural components. Capacities must be reduced by applicable deducts.

Weight of all load blocks, hooks, weight ball, slings, hoist lines, etc., beneath boom point sheaves, is considered part of main boom load. Weight of luffing jib and 5 000 kg suspended beneath luffing jib point sheaves have been included in capacity determination. Boom is not to be lowered beyond radii where combined weights are greater than rated capacity. Where no capacity is shown, operation is not intended or approved.

OPERATING CONDITIONS: Machine to operate on a firm, level, and uniformly supporting surface. Supporting surface and bearing turntable are to be level within a tolerance of 13 mm in 3 m. During operation, luffing jib must be maintained at proper boom-to-luffing jib angle shown in table. Refer to Luffing Jib Rigging **No. 81023384**, Mast Rigging **No. 81025690** or **No. 84045340**, Wire Rope Specification chart **No. 9568-A**, Counterweight Arrangement chart **No. 9345-A**, Luffing Jib Raising Procedure chart **No. 9502-AM**, and Wind Conditions chart **No. 9501-A**. Crane operator judgment must be used to allow for dynamic load effects of swinging, hoisting or lowering, travel, wind conditions, as well as adverse operating conditions and physical machine depreciation. Refer to the Operator Manual for operating guidelines.

MACHINE TRAVEL: Machine to travel on a firm, level, and uniformly supporting surface. Boom and luffing jib must be within angle range shown in capacity chart. Refer to Maximum Allowable Travel Specification chart **No. 9500-A**.

 **OPERATING RADIUS:** Operating radius is horizontal distance from axis of rotation to center of vertical hoist line or load block.



 **BOOM ANGLE:** Boom angle in degrees (°) is angle between horizontal and centerline of boom butt and inserts, and is an indication of operating radius. In all cases, operating radius shall govern capacity.

 **BOOM POINT ELEVATION:** Boom point elevation is vertical distance from ground level to centerline of boom point shaft.

MACHINE EQUIPMENT: Machine equipped with VPC-MAX, 9 700 mm crawlers, 1 219 mm or 1 524 mm treads, 9 144 mm live mast, 30,0 m mast, 10 part boom hoist reeving, boom support straps, 14 part luffing jib hoist reeving, luffing jib and backstay support straps, and 175 100 kg VPC.

Select counterweight position from Luffing Jib Raising Procedure chart **No. 9502-AM** that will allow raising and lowering of boom and luffing jib length. Counterweight position selection may be changed with luffing jib on ground or while luffing jib is within operating range of capacity chart.

Consult Chart **No. 9498-AM** for luffing jib capacities.

Luffing Jib Position During Operation	
 Luffing Jib Length Meters	 Boom-to-Luffing Jib Angle Degrees
24,0 - 30,0	140
36,0 - 48,0	155
54,0 - 96,0	169

Explanation of Symbols

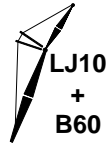

Luffing Jib No. LJ10:501
+
Boom No. B60:500



VPC (Variable Position Counterweight)



360 Degree Rating

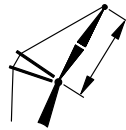

Luffing Jib Length



Boom-to-Luffing Jib Angle



Boom Length

REFERENCE ONLY!

Explanation of Symbols
(continued)



Operating Radius
(see page 1)



Boom Angle
(see page 1)

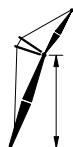

Boom Point Elevation
(see page 1)

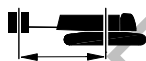

Counterweight Position
from Axis of Rotation



Lifting Capacities
(see page 1)

REFERENCE ONLY!

MLC300 VPC-MAX S-2

ASME B30.5

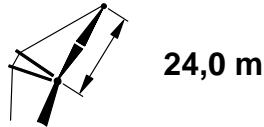
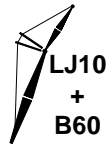

24,0 m



140°

42,0 m				
m	°	m	kg	kg
6,7	84,4	43,9	266 700	266 700
7,0	84,0	43,8	266 700	266 700
8,0	82,6	43,7	266 700	266 700
9,0	81,2	43,5	266 700	266 700
10,0	79,8	43,3	264 900	264 900
12,0	77,0	42,9	221 300	249 700
14,0	74,2	42,3	178 300	240 600
16,0	71,3	41,6	147 000	204 700
18,0	68,4	40,8	123 000	171 100
20,0	65,4	39,9	104 300	145 700
22,0	62,3	38,9	89 400	126 200
24,0	59,1	37,7	77 100	110 200
26,0	55,8	36,3	66 700	97 100
28,0	52,4	34,8	58 000	86 200
30,0	48,8	33,1	50 500	77 000
32,0	45,0	31,1	44 000	68 900

48,0 m				
m	°	m	kg	kg
7,3	84,4	49,8	246 800	246 800
8,0	83,5	49,8	246 800	246 800
9,0	82,3	49,6	246 800	246 800
10,0	81,1	49,4	246 800	246 800
12,0	78,7	49,0	221 900	238 000
14,0	76,2	48,5	178 700	220 900
16,0	73,7	48,0	147 400	205 300
18,0	71,2	47,3	123 300	171 500
20,0	68,7	46,5	104 500	146 100
22,0	66,1	45,6	89 500	126 400
24,0	63,4	44,6	77 100	110 400
26,0	60,6	43,5	66 700	97 200
28,0	57,8	42,2	58 000	86 300
30,0	54,9	40,8	50 500	77 000
32,0	51,9	39,3	43 900	69 000
34,0	48,7	37,6	38 200	62 100
36,0	45,4	35,6	33 100	56 000
38,0	41,9	33,4	28 600	50 600

MLC300 VPC-MAX S-2

ASME B30.5

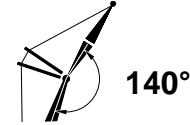
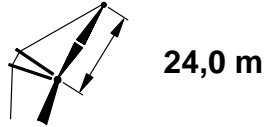
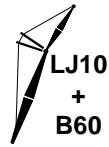

54,0 m				
m	°	m	10,6 m kg	14,6 m kg
7,3	85,0	55,9	224 100	224 100
8,0	84,3	55,8	224 100	224 100
9,0	83,2	55,7	224 100	224 100
10,0	82,1	55,5	224 100	224 100
12,0	80,0	55,2	219 600	222 300
14,0	77,8	54,7	179 400	211 800
16,0	75,6	54,2	148 000	200 500
18,0	73,4	53,6	123 800	172 100
20,0	71,1	52,9	105 000	146 600
22,0	68,9	52,2	90 000	126 900
24,0	66,6	51,3	77 600	110 900
26,0	64,2	50,3	67 200	97 600
28,0	61,8	49,3	58 400	86 700
30,0	59,3	48,1	50 900	77 400
32,0	56,8	46,8	44 200	69 300
34,0	54,2	45,4	38 500	62 400
36,0	51,5	43,8	33 400	56 300
38,0	48,7	42,0	28 900	50 900
40,0	45,7	40,1	24 800	46 100
42,0	42,6	38,0	21 200	41 800

60,0 m				
m	°	m	10,6 m kg	14,6 m kg
7,9	84,9	61,8	201 900	201 900
8,0	84,8	61,9	201 900	201 900
9,0	83,9	61,7	201 900	201 900
10,0	82,9	61,6	201 900	201 900
12,0	81,0	61,3	201 900	201 900
14,0	79,0	60,9	179 200	199 700
16,0	77,1	60,4	147 700	190 100
18,0	75,1	59,9	123 500	171 800
20,0	73,1	59,3	104 600	146 500
22,0	71,1	58,6	89 600	126 800
24,0	69,0	57,8	77 100	110 700
26,0	67,0	57,0	66 700	97 400
28,0	64,9	56,1	57 900	86 500
30,0	62,7	55,0	50 300	77 100
32,0	60,5	53,9	43 700	69 000
34,0	58,3	52,7	38 000	62 100
36,0	56,0	51,3	32 900	55 900
38,0	53,6	49,9	28 300	50 500
40,0	51,2	48,3	24 200	45 700
42,0	48,6	46,5	20 500	41 400
44,0	46,0	44,6	17 200	37 500
46,0	43,2	42,5	14 200	33 900

MLC300 VPC-MAX S-2

ASME B30.5

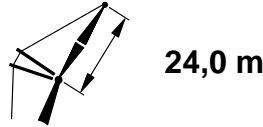

66,0 m				
			10,6 m	14,6 m
m	o	m	kg	kg
8,5	84,8	67,8	181 000	181 000
9,0	84,4	67,8	181 000	181 000
10,0	83,6	67,6	181 000	181 000
12,0	81,8	67,3	181 000	181 000
14,0	80,0	67,0	176 100	179 300
16,0	78,3	66,6	147 900	172 900
18,0	76,5	66,1	123 700	166 700
20,0	74,7	65,5	104 800	146 700
22,0	72,9	64,9	89 700	127 000
24,0	71,0	64,2	77 200	110 800
26,0	69,2	63,5	66 800	97 600
28,0	67,3	62,6	58 000	86 600
30,0	65,4	61,7	50 400	77 200
32,0	63,4	60,7	43 700	69 100
34,0	61,5	59,6	38 000	62 200
36,0	59,4	58,5	32 900	56 000
38,0	57,4	57,2	28 300	50 600
40,0	55,3	55,8	24 200	45 700
42,0	53,1	54,3	20 500	41 400
44,0	50,9	52,7	17 200	37 500
46,0	48,6	50,9	14 200	34 000
48,0	46,2	49,0	11 400	30 700
50,0	43,7	47,0	8 800	27 800

72,0 m				
			10,6 m	14,6 m
m	o	m	kg	kg
9,1	84,8	73,8	160 400	160 400
10,0	84,1	73,7	160 400	160 400
12,0	82,5	73,4	159 500	159 500
14,0	80,9	73,1	154 400	154 400
16,0	79,3	72,7	143 900	149 000
18,0	77,6	72,3	123 000	143 700
20,0	76,0	71,8	104 100	138 200
22,0	74,3	71,2	89 000	126 600
24,0	72,7	70,6	76 500	110 400
26,0	71,0	69,9	66 000	97 100
28,0	69,3	69,1	57 200	86 100
30,0	67,6	68,3	49 600	76 700
32,0	65,8	67,4	42 900	68 600
34,0	64,1	66,4	37 200	61 600
36,0	62,3	65,4	32 000	55 500
38,0	60,4	64,3	27 400	50 000
40,0	58,6	63,0	23 400	45 200
42,0	56,7	61,7	19 700	40 800
44,0	54,7	60,3	16 300	36 900
46,0	52,7	58,8	13 300	33 300
48,0	50,7	57,2	10 500	30 100
50,0	48,5	55,4	7 900	27 200
52,0	46,4	53,5		24 500
54,0	44,1	51,5		22 000
56,0	41,7	49,3		19 700

MLC300 VPC-MAX S-2

ASME B30.5

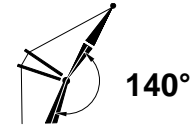
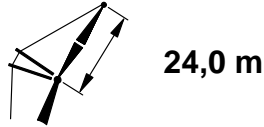
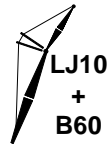

78,0 m				
m	°	m	10,6 m kg	14,6 m kg
9,8	84,7	79,8	130 600	130 600
10,0	84,6	79,7	130 600	130 600
12,0	83,1	79,5	130 600	130 600
14,0	81,6	79,2	130 300	130 400
16,0	80,1	78,8	128 500	128 500
18,0	78,6	78,4	121 200	126 700
20,0	77,1	78,0	103 900	125 500
22,0	75,6	77,5	88 800	122 300
24,0	74,0	76,9	76 300	110 400
26,0	72,5	76,2	65 800	97 000
28,0	71,0	75,6	57 000	86 000
30,0	69,4	74,8	49 300	76 600
32,0	67,8	74,0	42 600	68 400
34,0	66,2	73,1	36 900	61 500
36,0	64,6	72,2	31 700	55 300
38,0	62,9	71,1	27 100	49 800
40,0	61,2	70,0	23 000	45 000
42,0	59,5	68,9	19 300	40 600
44,0	57,8	67,6	16 000	36 700
46,0	56,0	66,3	12 900	33 100
48,0	54,2	64,8	10 100	29 900
50,0	52,4	63,3	7 600	27 000
52,0	50,5	61,7		24 200
54,0	48,5	59,9		21 700
56,0	46,5	58,0		19 400
58,0	44,4	56,0		17 300
60,0	42,2	53,8		15 300

84,0 m				
m	°	m	10,6 m kg	14,6 m kg
10,4	84,7	85,7	108 300	108 500
12,0	83,6	85,5	108 300	108 500
14,0	82,2	85,3	108 300	108 500
16,0	80,8	84,9	108 300	108 500
18,0	79,4	84,6	108 300	108 500
20,0	78,0	84,1	103 100	108 500
22,0	76,6	83,7	88 000	108 500
24,0	75,2	83,1	75 400	106 800
26,0	73,8	82,5	64 900	96 400
28,0	72,4	81,9	56 000	85 400
30,0	70,9	81,2	48 400	76 000
32,0	69,5	80,5	41 700	67 800
34,0	68,0	79,7	35 900	60 800
36,0	66,5	78,8	30 800	54 600
38,0	65,0	77,9	26 100	49 100
40,0	63,5	76,9	22 000	44 300
42,0	61,9	75,8	18 400	40 000
44,0	60,4	74,7	15 000	36 000
46,0	58,8	73,5	11 900	32 400
48,0	57,2	72,2	9 100	29 200
50,0	55,5	70,8	6 600	26 200
52,0	53,8	69,3		23 500
54,0	52,1	67,8		21 000
56,0	50,3	66,1		18 700
58,0	48,5	64,4		16 500
60,0	46,6	62,5		14 600
62,0	44,7	60,5		12 700
64,0	42,7	58,3		10 900

MLC300 VPC-MAX S-2

ASME B30.5

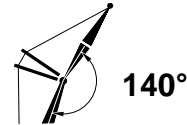
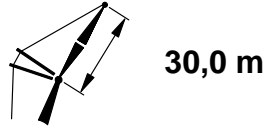
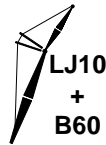

42,0 m				
m	°	m	kg	kg
6,7	84,4	43,9	263 600	263 600
7,0	84,0	43,8	263 600	263 600
8,0	82,6	43,7	263 500	263 500
9,0	81,2	43,5	263 500	263 500
10,0	79,8	43,3	261 400	261 400
12,0	77,0	42,9	213 400	245 900
14,0	74,2	42,3	171 200	237 900
16,0	71,3	41,6	140 500	199 300
18,0	68,4	40,8	117 000	166 100
20,0	65,4	39,9	98 600	141 100
22,0	62,3	38,9	84 100	121 800
24,0	59,1	37,7	72 000	106 100
26,0	55,8	36,3	61 900	93 200
28,0	52,4	34,8	53 400	82 600
30,0	48,8	33,1	46 100	73 500
32,0	45,0	31,1	39 700	65 600

48,0 m				
m	°	m	kg	kg
7,3	84,4	49,8	242 200	242 200
8,0	83,5	49,8	242 100	242 100
9,0	82,3	49,6	242 100	242 100
10,0	81,1	49,4	242 100	242 100
12,0	78,7	49,0	214 100	235 600
14,0	76,2	48,5	171 800	220 700
16,0	73,7	48,0	141 000	199 900
18,0	71,2	47,3	117 400	166 600
20,0	68,7	46,5	99 000	141 600
22,0	66,1	45,6	84 300	122 200
24,0	63,4	44,6	72 200	106 400
26,0	60,6	43,5	62 000	93 400
28,0	57,8	42,2	53 500	82 800
30,0	54,9	40,8	46 100	73 600
32,0	51,9	39,3	39 700	65 700
34,0	48,7	37,6	34 100	58 900
36,0	45,4	35,6	29 200	52 900
38,0	41,9	33,4	24 800	47 600

MLC300 VPC-MAX S-2

ASME B30.5

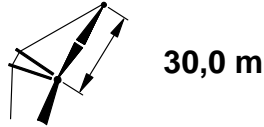
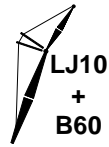

54,0 m				
m	°	m	10,6 m kg	14,6 m kg
7,3	85,0	55,9	219 900	219 900
8,0	84,3	55,8	219 900	219 900
9,0	83,2	55,7	219 900	219 900
10,0	82,1	55,5	219 900	219 900
12,0	80,0	55,2	213 100	219 900
14,0	77,8	54,7	172 600	209 200
16,0	75,6	54,2	141 700	197 700
18,0	73,4	53,6	118 000	167 300
20,0	71,1	52,9	99 600	142 200
22,0	68,9	52,2	84 900	122 800
24,0	66,6	51,3	72 700	107 000
26,0	64,2	50,3	62 500	94 000
28,0	61,8	49,3	54 000	83 200
30,0	59,3	48,1	46 600	74 000
32,0	56,8	46,8	40 100	66 100
34,0	54,2	45,4	34 500	59 300
36,0	51,5	43,8	29 500	53 300
38,0	48,7	42,0	25 100	47 900
40,0	45,7	40,1	21 200	43 200
42,0	42,6	38,0	17 600	39 000

60,0 m				
m	°	m	10,6 m kg	14,6 m kg
7,9	84,9	61,8	198 200	198 200
8,0	84,8	61,9	198 200	198 200
9,0	83,9	61,7	198 200	198 200
10,0	82,9	61,6	198 200	198 200
12,0	81,0	61,3	198 200	198 200
14,0	79,0	60,9	172 500	196 500
16,0	77,1	60,4	141 600	187 800
18,0	75,1	59,9	117 800	167 300
20,0	73,1	59,3	99 300	142 200
22,0	71,1	58,6	84 600	122 700
24,0	69,0	57,8	72 400	106 900
26,0	67,0	57,0	62 100	93 800
28,0	64,9	56,1	53 600	83 000
30,0	62,7	55,0	46 100	73 800
32,0	60,5	53,9	39 600	65 800
34,0	58,3	52,7	34 000	59 000
36,0	56,0	51,3	29 000	53 000
38,0	53,6	49,9	24 500	47 600
40,0	51,2	48,3	20 600	42 900
42,0	48,6	46,5	17 000	38 600
44,0	46,0	44,6	13 700	34 800
46,0	43,2	42,5	10 800	31 300

MLC300 VPC-MAX S-2

ASME B30.5

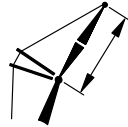
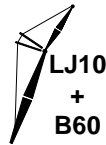

30,0 m



140°

66,0 m				
			10,6 m	14,6 m
m	°	m	kg	kg
8,5	84,8	67,8	177 500	177 600
9,0	84,4	67,8	177 500	177 600
10,0	83,6	67,6	177 500	177 600
12,0	81,8	67,3	177 500	177 600
14,0	80,0	67,0	171 500	175 000
16,0	78,3	66,6	141 800	168 600
18,0	76,5	66,1	118 100	162 400
20,0	74,7	65,5	99 500	142 500
22,0	72,9	64,9	84 800	123 000
24,0	71,0	64,2	72 500	107 100
26,0	69,2	63,5	62 300	94 000
28,0	67,3	62,6	53 700	83 200
30,0	65,4	61,7	46 200	74 000
32,0	63,4	60,7	39 700	66 000
34,0	61,5	59,6	34 100	59 100
36,0	59,4	58,5	29 100	53 100
38,0	57,4	57,2	24 600	47 700
40,0	55,3	55,8	20 600	43 000
42,0	53,1	54,3	17 000	38 700
44,0	50,9	52,7	13 800	34 900
46,0	48,6	50,9	10 800	31 400
48,0	46,2	49,0	8 100	28 200
50,0	43,7	47,0	5 600	25 300

72,0 m				
			10,6 m	14,6 m
m	°	m	kg	kg
9,1	84,8	73,8	158 000	158 000
10,0	84,1	73,7	158 000	158 000
12,0	82,5	73,4	155 500	155 500
14,0	80,9	73,1	150 300	150 300
16,0	79,3	72,7	139 000	144 900
18,0	77,6	72,3	117 500	139 600
20,0	76,0	71,8	98 900	134 000
22,0	74,3	71,2	84 100	122 600
24,0	72,7	70,6	71 900	106 700
26,0	71,0	69,9	61 600	93 600
28,0	69,3	69,1	53 000	82 800
30,0	67,6	68,3	45 500	73 500
32,0	65,8	67,4	39 000	65 500
34,0	64,1	66,4	33 300	58 600
36,0	62,3	65,4	28 300	52 600
38,0	60,4	64,3	23 800	47 200
40,0	58,6	63,0	19 800	42 400
42,0	56,7	61,7	16 200	38 100
44,0	54,7	60,3	12 900	34 300
46,0	52,7	58,8	9 900	30 800
48,0	50,7	57,2	7 200	27 600
50,0	48,5	55,4		24 700
52,0	46,4	53,5		22 100
54,0	44,1	51,5		19 600
56,0	41,7	49,3		17 300

MLC300 VPC-MAX S-2

ASME B30.5

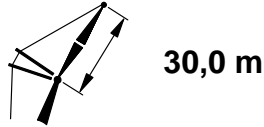
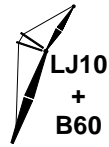

78,0 m				
m	°	m	10,6 m kg	14,6 m kg
9,8	84,7	79,8	128 200	128 200
10,0	84,6	79,7	128 200	128 200
12,0	83,1	79,5	128 200	128 200
14,0	81,6	79,2	127 700	127 700
16,0	80,1	78,8	124 600	124 600
18,0	78,6	78,4	116 100	122 900
20,0	77,1	78,0	98 800	121 700
22,0	75,6	77,5	84 000	118 500
24,0	74,0	76,9	71 700	106 700
26,0	72,5	76,2	61 400	93 500
28,0	71,0	75,6	52 800	82 700
30,0	69,4	74,8	45 300	73 400
32,0	67,8	74,0	38 700	65 400
34,0	66,2	73,1	33 100	58 500
36,0	64,6	72,2	28 000	52 400
38,0	62,9	71,1	23 500	47 000
40,0	61,2	70,0	19 500	42 300
42,0	59,5	68,9	15 900	38 000
44,0	57,8	67,6	12 600	34 100
46,0	56,0	66,3	9 600	30 600
48,0	54,2	64,8	6 900	27 400
50,0	52,4	63,3		24 500
52,0	50,5	61,7		21 900
54,0	48,5	59,9		19 400
56,0	46,5	58,0		17 100
58,0	44,4	56,0		15 000
60,0	42,2	53,8		13 100

84,0 m				
m	°	m	10,6 m kg	14,6 m kg
10,4	84,7	85,7	106 000	106 200
12,0	83,6	85,5	106 000	106 200
14,0	82,2	85,3	106 000	106 200
16,0	80,8	84,9	106 000	106 200
18,0	79,4	84,6	106 000	106 200
20,0	78,0	84,1	98 000	106 200
22,0	76,6	83,7	83 200	106 200
24,0	75,2	83,1	70 900	103 200
26,0	73,8	82,5	60 500	93 000
28,0	72,4	81,9	51 900	82 100
30,0	70,9	81,2	44 400	72 800
32,0	69,5	80,5	37 800	64 800
34,0	68,0	79,7	32 200	57 900
36,0	66,5	78,8	27 100	51 800
38,0	65,0	77,9	22 600	46 400
40,0	63,5	76,9	18 600	41 600
42,0	61,9	75,8	15 000	37 300
44,0	60,4	74,7	11 700	33 400
46,0	58,8	73,5	8 700	29 900
48,0	57,2	72,2	5 900	26 800
50,0	55,5	70,8		23 800
52,0	53,8	69,3		21 200
54,0	52,1	67,8		18 700
56,0	50,3	66,1		16 400
58,0	48,5	64,4		14 300
60,0	46,6	62,5		12 300
62,0	44,7	60,5		10 500
64,0	42,7	58,3		8 500

MLC300 VPC-MAX S-2

ASME B30.5

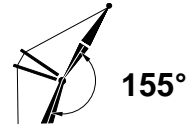
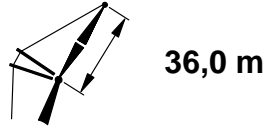
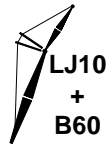

42,0 m				
			10,6 m	14,6 m
m	°	m	kg	kg
6,7	84,4	43,9	264 000	264 000
7,0	84,0	43,8	263 900	263 900
8,0	82,6	43,7	263 600	263 600
9,0	81,2	43,5	263 400	263 400
10,0	79,8	43,3	261 600	261 600
12,0	77,0	42,9	214 300	246 300
14,0	74,2	42,3	171 300	237 900
16,0	71,3	41,6	140 000	199 000
18,0	68,4	40,8	116 000	165 400
20,0	65,4	39,9	97 300	140 100
22,0	62,3	38,9	82 400	120 600
24,0	59,1	37,7	70 100	104 600
26,0	55,8	36,3	59 700	91 500
28,0	52,4	34,8	51 000	80 700
30,0	48,8	33,1	43 500	71 500
32,0	45,0	31,1	37 000	63 500
34,0	40,9	28,8	31 300	56 600
36,0	36,3	26,2	26 300	50 600
38,0	31,2	23,0	21 800	45 300

48,0 m				
			10,6 m	14,6 m
m	°	m	kg	kg
7,3	84,4	49,8	242 200	242 200
8,0	83,5	49,8	242 000	242 000
9,0	82,3	49,6	241 900	241 900
10,0	81,1	49,4	241 900	241 900
12,0	78,7	49,0	215 400	236 300
14,0	76,2	48,5	172 300	220 600
16,0	73,7	48,0	140 900	200 000
18,0	71,2	47,3	116 800	166 300
20,0	68,7	46,5	98 000	140 900
22,0	66,1	45,6	83 100	121 300
24,0	63,4	44,6	70 700	105 300
26,0	60,6	43,5	60 300	92 100
28,0	57,8	42,2	51 600	81 300
30,0	54,9	40,8	44 100	72 000
32,0	51,9	39,3	37 500	64 000
34,0	48,7	37,6	31 800	57 100
36,0	45,4	35,6	26 700	51 000
38,0	41,9	33,4	22 200	45 600
40,0	38,0	30,9	18 100	40 900
42,0	33,8	28,0	14 500	36 600
44,0	29,1	24,6	11 200	32 700

MLC300 VPC-MAX S-2

ASME B30.5

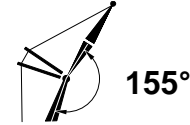
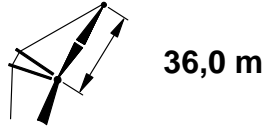
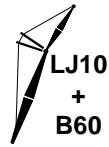

54,0 m				
m	°	m	10,6 m kg	14,6 m kg
7,3	85,0	55,9	219 700	219 700
8,0	84,3	55,8	219 600	219 600
9,0	83,2	55,7	219 600	219 600
10,0	82,1	55,5	219 600	219 600
12,0	80,0	55,2	214 100	219 600
14,0	77,8	54,7	173 400	209 700
16,0	75,6	54,2	142 000	198 000
18,0	73,4	53,6	117 800	167 200
20,0	71,1	52,9	99 000	141 800
22,0	68,9	52,2	84 000	122 100
24,0	66,6	51,3	71 600	106 100
26,0	64,2	50,3	61 200	92 900
28,0	61,8	49,3	52 400	82 100
30,0	59,3	48,1	44 900	72 700
32,0	56,8	46,8	38 300	64 700
34,0	54,2	45,4	32 500	57 800
36,0	51,5	43,8	27 500	51 700
38,0	48,7	42,0	22 900	46 200
40,0	45,7	40,1	18 900	41 500
42,0	42,6	38,0	15 200	37 200
44,0	39,3	35,6	11 900	33 300
46,0	35,7	32,8	8 900	29 800
48,0	31,8	29,7	6 100	26 600
50,0	27,3	26,0		23 700

60,0 m				
m	°	m	10,6 m kg	14,6 m kg
7,9	84,9	61,8	197 600	197 600
8,0	84,8	61,9	197 600	197 600
9,0	83,9	61,7	197 600	197 600
10,0	82,9	61,6	197 600	197 600
12,0	81,0	61,3	197 600	197 600
14,0	79,0	60,9	173 500	196 200
16,0	77,1	60,4	142 000	188 100
18,0	75,1	59,9	117 800	167 500
20,0	73,1	59,3	99 000	142 000
22,0	71,1	58,6	84 000	122 300
24,0	69,0	57,8	71 500	106 200
26,0	67,0	57,0	61 000	93 000
28,0	64,9	56,1	52 300	82 100
30,0	62,7	55,0	44 700	72 700
32,0	60,5	53,9	38 100	64 600
34,0	58,3	52,7	32 300	57 700
36,0	56,0	51,3	27 200	51 600
38,0	53,6	49,9	22 700	46 200
40,0	51,2	48,3	18 600	41 400
42,0	48,6	46,5	14 900	37 100
44,0	46,0	44,6	11 600	33 100
46,0	43,2	42,5	8 600	29 600
48,0	40,3	40,2	5 800	26 400
50,0	37,2	37,6		23 500
52,0	33,8	34,7		20 800
54,0	30,1	31,3		18 300

MLC300 VPC-MAX S-2

ASME B30.5

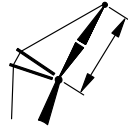
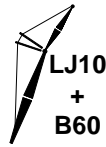

36,0 m



155°

66,0 m				
			10,6 m	14,6 m
m	°	m	kg	kg
8,5	84,8	67,8	176 800	176 800
9,0	84,4	67,8	176 800	176 800
10,0	83,6	67,6	176 800	176 800
12,0	81,8	67,3	176 800	176 800
14,0	80,0	67,0	171 900	175 400
16,0	78,3	66,6	142 500	168 900
18,0	76,5	66,1	118 300	162 700
20,0	74,7	65,5	99 400	142 400
22,0	72,9	64,9	84 400	122 700
24,0	71,0	64,2	71 900	106 600
26,0	69,2	63,5	61 400	93 400
28,0	67,3	62,6	52 700	82 400
30,0	65,4	61,7	45 100	73 100
32,0	63,4	60,7	38 400	65 000
34,0	61,5	59,6	32 700	58 000
36,0	59,4	58,5	27 500	51 900
38,0	57,4	57,2	23 000	46 500
40,0	55,3	55,8	18 900	41 600
42,0	53,1	54,3	15 200	37 300
44,0	50,9	52,7	11 900	33 400
46,0	48,6	50,9	8 800	29 900
48,0	46,2	49,0	6 100	26 700
50,0	43,7	47,0		23 700
52,0	41,0	44,7		21 000
54,0	38,3	42,2		18 600
56,0	35,3	39,4		16 300
58,0	32,1	36,3		14 100
60,0	28,6	32,8		12 200

72,0 m				
			10,6 m	14,6 m
m	°	m	kg	kg
9,1	84,8	73,8	156 200	156 200
10,0	84,1	73,7	156 200	156 200
12,0	82,5	73,4	155 500	155 500
14,0	80,9	73,1	150 500	150 500
16,0	79,3	72,7	139 400	145 100
18,0	77,6	72,3	117 900	139 800
20,0	76,0	71,8	98 900	134 200
22,0	74,3	71,2	83 900	122 500
24,0	72,7	70,6	71 400	106 400
26,0	71,0	69,9	60 900	93 100
28,0	69,3	69,1	52 100	82 100
30,0	67,6	68,3	44 500	72 700
32,0	65,8	67,4	37 800	64 600
34,0	64,1	66,4	32 100	57 700
36,0	62,3	65,4	26 900	51 500
38,0	60,4	64,3	22 400	46 100
40,0	58,6	63,0	18 300	41 300
42,0	56,7	61,7	14 600	36 900
44,0	54,7	60,3	11 200	33 000
46,0	52,7	58,8	8 200	29 500
48,0	50,7	57,2		26 200
50,0	48,5	55,4		23 300
52,0	46,4	53,5		20 600
54,0	44,1	51,5		18 100
56,0	41,7	49,3		15 800
58,0	39,2	46,8		13 600
60,0	36,6	44,2		11 700
62,0	33,7	41,3		9 800
64,0	30,7	38,0		7 900
66,0	27,3	34,2		5 900

MLC300 VPC-MAX S-2

ASME B30.5

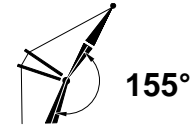
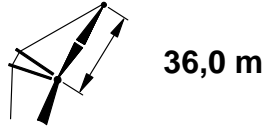
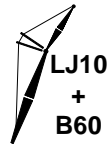

78,0 m				
m	°	m	kg	kg
9,8	84,7	79,8	126 500	126 500
10,0	84,6	79,7	126 500	126 500
12,0	83,1	79,5	126 500	126 500
14,0	81,6	79,2	126 300	126 300
16,0	80,1	78,8	124 600	124 600
18,0	78,6	78,4	116 400	122 800
20,0	77,1	78,0	99 000	121 500
22,0	75,6	77,5	83 900	118 300
24,0	74,0	76,9	71 400	106 500
26,0	72,5	76,2	60 900	93 200
28,0	71,0	75,6	52 100	82 200
30,0	69,4	74,8	44 400	72 800
32,0	67,8	74,0	37 700	64 600
34,0	66,2	73,1	32 000	57 700
36,0	64,6	72,2	26 800	51 500
38,0	62,9	71,1	22 200	46 100
40,0	61,2	70,0	18 200	41 200
42,0	59,5	68,9	14 500	36 900
44,0	57,8	67,6	11 100	33 000
46,0	56,0	66,3	8 100	29 400
48,0	54,2	64,8		26 200
50,0	52,4	63,3		23 200
52,0	50,5	61,7		20 500
54,0	48,5	59,9		18 000
56,0	46,5	58,0		15 700
58,0	44,4	56,0		13 600
60,0	42,2	53,8		11 600
62,0	40,0	51,5		9 700
64,0	37,6	48,9		7 600
66,0	35,0	46,1		5 600

84,0 m				
m	°	m	kg	kg
10,4	84,7	85,7	104 400	104 600
12,0	83,6	85,5	104 400	104 600
14,0	82,2	85,3	104 400	104 600
16,0	80,8	84,9	104 400	104 600
18,0	79,4	84,6	104 400	104 600
20,0	78,0	84,1	98 300	104 600
22,0	76,6	83,7	83 200	104 500
24,0	75,2	83,1	70 700	101 500
26,0	73,8	82,5	60 100	92 700
28,0	72,4	81,9	51 300	81 700
30,0	70,9	81,2	43 700	72 300
32,0	69,5	80,5	37 000	64 200
34,0	68,0	79,7	31 200	57 200
36,0	66,5	78,8	26 100	51 000
38,0	65,0	77,9	21 400	45 500
40,0	63,5	76,9	17 400	40 700
42,0	61,9	75,8	13 700	36 300
44,0	60,4	74,7	10 300	32 400
46,0	58,8	73,5	7 200	28 900
48,0	57,2	72,2		25 600
50,0	55,5	70,8		22 700
52,0	53,8	69,3		19 900
54,0	52,1	67,8		17 400
56,0	50,3	66,1		15 100
58,0	48,5	64,4		13 000
60,0	46,6	62,5		10 900
62,0	44,7	60,5		8 800
64,0	42,7	58,3		6 700

MLC300 VPC-MAX S-2

ASME B30.5

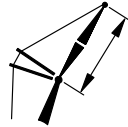
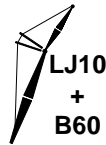

42,0 m



155°

42,0 m				
			10,6 m	14,6 m
m	°	m	kg	kg
6,7	84,4	43,9	259 100	259 100
7,0	84,0	43,8	258 900	258 900
8,0	82,6	43,7	258 500	258 500
9,0	81,2	43,5	258 200	258 200
10,0	79,8	43,3	257 000	257 000
12,0	77,0	42,9	207 000	242 700
14,0	74,2	42,3	164 600	233 000
16,0	71,3	41,6	133 800	193 700
18,0	68,4	40,8	110 100	160 500
20,0	65,4	39,9	91 700	135 500
22,0	62,3	38,9	77 100	116 200
24,0	59,1	37,7	64 900	100 500
26,0	55,8	36,3	54 700	87 500
28,0	52,4	34,8	46 200	76 900
30,0	48,8	33,1	38 800	67 800
32,0	45,0	31,1	32 400	59 900
34,0	40,9	28,8	26 900	53 100
36,0	36,3	26,2	22 000	47 200
38,0	31,2	23,0	17 600	42 000

48,0 m				
			10,6 m	14,6 m
m	°	m	kg	kg
7,3	84,4	49,8	237 700	237 700
8,0	83,5	49,8	237 500	237 500
9,0	82,3	49,6	237 300	237 300
10,0	81,1	49,4	237 200	237 200
12,0	78,7	49,0	208 300	233 100
14,0	76,2	48,5	165 800	221 400
16,0	73,7	48,0	134 900	194 900
18,0	71,2	47,3	111 200	161 600
20,0	68,7	46,5	92 700	136 500
22,0	66,1	45,6	78 000	117 100
24,0	63,4	44,6	65 700	101 300
26,0	60,6	43,5	55 500	88 300
28,0	57,8	42,2	46 900	77 600
30,0	54,9	40,8	39 500	68 400
32,0	51,9	39,3	33 000	60 500
34,0	48,7	37,6	27 500	53 700
36,0	45,4	35,6	22 500	47 700
38,0	41,9	33,4	18 000	42 400
40,0	38,0	30,9	14 100	37 700
42,0	33,8	28,0	10 600	33 600
44,0	29,1	24,6	7 400	29 800

MLC300 VPC-MAX S-2

ASME B30.5

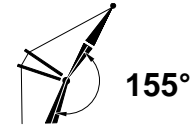
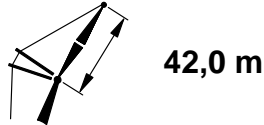
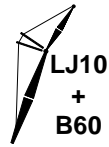

54,0 m				
m	°	m	kg	kg
7,3	85,0	55,9	215 600	215 600
8,0	84,3	55,8	215 500	215 500
9,0	83,2	55,7	215 500	215 500
10,0	82,1	55,5	215 400	215 400
12,0	80,0	55,2	208 100	215 400
14,0	77,8	54,7	167 100	206 800
16,0	75,6	54,2	136 100	194 200
18,0	73,4	53,6	112 300	162 700
20,0	71,1	52,9	93 800	137 600
22,0	68,9	52,2	79 100	118 100
24,0	66,6	51,3	66 800	102 300
26,0	64,2	50,3	56 500	89 200
28,0	61,8	49,3	47 900	78 500
30,0	59,3	48,1	40 500	69 300
32,0	56,8	46,8	34 000	61 300
34,0	54,2	45,4	28 400	54 500
36,0	51,5	43,8	23 400	48 500
38,0	48,7	42,0	18 900	43 100
40,0	45,7	40,1	14 900	38 400
42,0	42,6	38,0	11 400	34 200
44,0	39,3	35,6	8 100	30 400
46,0	35,7	32,8		26 900
48,0	31,8	29,7		23 800
50,0	27,3	26,0		21 000

60,0 m				
m	°	m	kg	kg
7,9	84,9	61,8	193 900	193 900
8,0	84,8	61,9	193 900	193 900
9,0	83,9	61,7	193 900	193 900
10,0	82,9	61,6	193 900	193 900
12,0	81,0	61,3	193 900	193 900
14,0	79,0	60,9	167 400	193 500
16,0	77,1	60,4	136 300	186 800
18,0	75,1	59,9	112 500	163 100
20,0	73,1	59,3	93 900	137 800
22,0	71,1	58,6	79 100	118 400
24,0	69,0	57,8	66 800	102 500
26,0	67,0	57,0	56 500	89 400
28,0	64,9	56,1	47 900	78 600
30,0	62,7	55,0	40 500	69 400
32,0	60,5	53,9	33 900	61 400
34,0	58,3	52,7	28 300	54 600
36,0	56,0	51,3	23 300	48 500
38,0	53,6	49,9	18 800	43 100
40,0	51,2	48,3	14 800	38 400
42,0	48,6	46,5	11 200	34 200
44,0	46,0	44,6	7 900	30 300
46,0	43,2	42,5		26 800
48,0	40,3	40,2		23 700
50,0	37,2	37,6		20 800
52,0	33,8	34,7		18 200
54,0	30,1	31,3		15 800

MLC300 VPC-MAX S-2

ASME B30.5

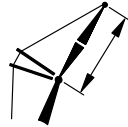
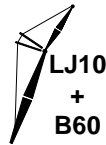

42,0 m



155°

66,0 m				
			10,6 m	14,6 m
m	°	m	kg	kg
8,5	84,8	67,8	173 300	173 300
9,0	84,4	67,8	173 300	173 300
10,0	83,6	67,6	173 300	173 300
12,0	81,8	67,3	173 300	173 300
14,0	80,0	67,0	167 600	171 300
16,0	78,3	66,6	136 900	164 800
18,0	76,5	66,1	113 100	158 500
20,0	74,7	65,5	94 400	138 400
22,0	72,9	64,9	79 600	118 900
24,0	71,0	64,2	67 300	103 000
26,0	69,2	63,5	57 000	89 900
28,0	67,3	62,6	48 400	79 100
30,0	65,4	61,7	40 900	69 800
32,0	63,4	60,7	34 400	61 800
34,0	61,5	59,6	28 700	55 000
36,0	59,4	58,5	23 700	48 900
38,0	57,4	57,2	19 200	43 500
40,0	55,3	55,8	15 200	38 800
42,0	53,1	54,3	11 600	34 500
44,0	50,9	52,7	8 300	30 600
46,0	48,6	50,9		27 200
48,0	46,2	49,0		24 000
50,0	43,7	47,0		21 100
52,0	41,0	44,7		18 400
54,0	38,3	42,2		16 000
56,0	35,3	39,4		13 700
58,0	32,1	36,3		11 700
60,0	28,6	32,8		9 700

72,0 m				
			10,6 m	14,6 m
m	°	m	kg	kg
9,1	84,8	73,8	153 600	153 600
10,0	84,1	73,7	153 600	153 600
12,0	82,5	73,4	151 900	151 900
14,0	80,9	73,1	146 600	146 600
16,0	79,3	72,7	134 800	141 200
18,0	77,6	72,3	112 700	135 800
20,0	76,0	71,8	94 100	130 200
22,0	74,3	71,2	79 300	118 800
24,0	72,7	70,6	66 900	102 800
26,0	71,0	69,9	56 600	89 700
28,0	69,3	69,1	48 000	78 900
30,0	67,6	68,3	40 500	69 600
32,0	65,8	67,4	33 900	61 500
34,0	64,1	66,4	28 200	54 700
36,0	62,3	65,4	23 200	48 600
38,0	60,4	64,3	18 700	43 200
40,0	58,6	63,0	14 700	38 400
42,0	56,7	61,7	11 000	34 200
44,0	54,7	60,3	7 700	30 300
46,0	52,7	58,8		26 800
48,0	50,7	57,2		23 600
50,0	48,5	55,4		20 700
52,0	46,4	53,5		18 000
54,0	44,1	51,5		15 600
56,0	41,7	49,3		13 300
58,0	39,2	46,8		11 200
60,0	36,6	44,2		9 100
62,0	33,7	41,3		6 900
64,0	30,7	38,0		4 800

MLC300 VPC-MAX S-2

ASME B30.5

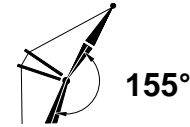
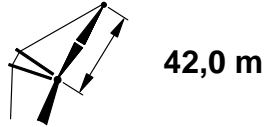
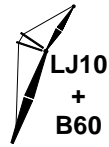

78,0 m				
m	°	m	kg	kg
9,8	84,7	79,8	123 900	123 900
10,0	84,6	79,7	123 900	123 900
12,0	83,1	79,5	123 900	123 900
14,0	81,6	79,2	123 500	123 500
16,0	80,1	78,8	120 900	120 900
18,0	78,6	78,4	111 700	119 000
20,0	77,1	78,0	94 200	117 800
22,0	75,6	77,5	79 400	114 600
24,0	74,0	76,9	67 000	103 000
26,0	72,5	76,2	56 700	89 800
28,0	71,0	75,6	48 000	79 000
30,0	69,4	74,8	40 500	69 700
32,0	67,8	74,0	33 900	61 600
34,0	66,2	73,1	28 200	54 700
36,0	64,6	72,2	23 200	48 700
38,0	62,9	71,1	18 600	43 300
40,0	61,2	70,0	14 600	38 500
42,0	59,5	68,9	11 000	34 200
44,0	57,8	67,6	7 700	30 300
46,0	56,0	66,3		26 800
48,0	54,2	64,8		23 600
50,0	52,4	63,3		20 700
52,0	50,5	61,7		18 000
54,0	48,5	59,9		15 600
56,0	46,5	58,0		13 300
58,0	44,4	56,0		11 200
60,0	42,2	53,8		8 900
62,0	40,0	51,5		6 700
64,0	37,6	48,9		4 600

84,0 m				
m	°	m	kg	kg
10,4	84,7	85,7	101 900	102 100
12,0	83,6	85,5	101 900	102 100
14,0	82,2	85,3	101 900	102 100
16,0	80,8	84,9	101 900	102 100
18,0	79,4	84,6	101 900	102 100
20,0	78,0	84,1	93 600	102 100
22,0	76,6	83,7	78 800	101 300
24,0	75,2	83,1	66 400	97 400
26,0	73,8	82,5	56 000	89 500
28,0	72,4	81,9	47 300	78 600
30,0	70,9	81,2	39 800	69 300
32,0	69,5	80,5	33 200	61 200
34,0	68,0	79,7	27 500	54 300
36,0	66,5	78,8	22 400	48 200
38,0	65,0	77,9	17 900	42 800
40,0	63,5	76,9	13 900	38 000
42,0	61,9	75,8	10 200	33 700
44,0	60,4	74,7	6 900	29 800
46,0	58,8	73,5		26 300
48,0	57,2	72,2		23 100
50,0	55,5	70,8		20 200
52,0	53,8	69,3		17 500
54,0	52,1	67,8		15 000
56,0	50,3	66,1		12 700
58,0	48,5	64,4		10 400
60,0	46,6	62,5		8 000
62,0	44,7	60,5		5 800

MLC300 VPC-MAX S-2

ASME B30.5

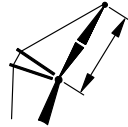
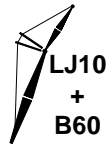

48,0 m



155°

42,0 m				
m	°	m	kg	kg
6,7	84,4	43,9	253 400	253 400
7,0	84,0	43,8	253 200	253 200
8,0	82,6	43,7	252 700	252 700
9,0	81,2	43,5	252 200	252 200
10,0	79,8	43,3	250 000	251 900
12,0	77,0	42,9	198 800	238 500
14,0	74,2	42,3	157 100	227 500
16,0	71,3	41,6	126 800	187 800
18,0	68,4	40,8	103 600	155 100
20,0	65,4	39,9	85 500	130 400
22,0	62,3	38,9	71 100	111 400
24,0	59,1	37,7	59 200	95 900
26,0	55,8	36,3	49 200	83 100
28,0	52,4	34,8	40 800	72 600
30,0	48,8	33,1	33 600	63 600
32,0	45,0	31,1	27 300	55 900
34,0	40,9	28,8	21 900	49 300
36,0	36,3	26,2	17 200	43 500
38,0	31,2	23,0	12 900	38 300

48,0 m				
m	°	m	kg	kg
7,3	84,4	49,8	232 600	232 600
8,0	83,5	49,8	232 400	232 400
9,0	82,3	49,6	232 100	232 100
10,0	81,1	49,4	231 900	231 900
12,0	78,7	49,0	200 400	228 800
14,0	76,2	48,5	158 600	222 200
16,0	73,7	48,0	128 200	189 300
18,0	71,2	47,3	104 900	156 400
20,0	68,7	46,5	86 700	131 600
22,0	66,1	45,6	72 200	112 500
24,0	63,4	44,6	60 200	96 900
26,0	60,6	43,5	50 200	84 100
28,0	57,8	42,2	41 800	73 500
30,0	54,9	40,8	34 500	64 500
32,0	51,9	39,3	28 200	56 700
34,0	48,7	37,6	22 700	50 000
36,0	45,4	35,6	17 900	44 100
38,0	41,9	33,4	13 500	38 900
40,0	38,0	30,9	9 700	34 300
42,0	33,8	28,0	6 300	30 200
44,0	29,1	24,6		26 500

MLC300 VPC-MAX S-2

ASME B30.5

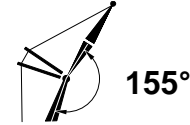
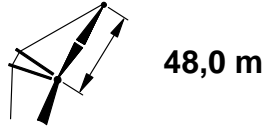
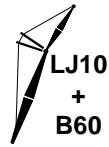

54,0 m				
m	°	m	10,6 m kg	14,6 m kg
7,3	85,0	55,9	211 100	211 100
8,0	84,3	55,8	210 900	210 900
9,0	83,2	55,7	210 800	210 800
10,0	82,1	55,5	210 700	210 700
12,0	80,0	55,2	201 300	210 600
14,0	77,8	54,7	160 100	203 600
16,0	75,6	54,2	129 600	189 700
18,0	73,4	53,6	106 200	157 600
20,0	71,1	52,9	88 000	132 800
22,0	68,9	52,2	73 500	113 700
24,0	66,6	51,3	61 500	98 000
26,0	64,2	50,3	51 400	85 200
28,0	61,8	49,3	43 000	74 600
30,0	59,3	48,1	35 700	65 500
32,0	56,8	46,8	29 300	57 600
34,0	54,2	45,4	23 800	50 900
36,0	51,5	43,8	18 900	45 000
38,0	48,7	42,0	14 500	39 700
40,0	45,7	40,1	10 600	35 100
42,0	42,6	38,0	7 200	30 900
44,0	39,3	35,6		27 200
46,0	35,7	32,8		23 800
48,0	31,8	29,7		20 800
50,0	27,3	26,0		18 000

60,0 m				
m	°	m	10,6 m kg	14,6 m kg
7,9	84,9	61,8	189 700	189 700
8,0	84,8	61,9	189 700	189 700
9,0	83,9	61,7	189 700	189 700
10,0	82,9	61,6	189 700	189 700
12,0	81,0	61,3	189 700	189 700
14,0	79,0	60,9	160 500	189 700
16,0	77,1	60,4	130 000	183 200
18,0	75,1	59,9	106 600	158 100
20,0	73,1	59,3	88 300	133 300
22,0	71,1	58,6	73 800	114 000
24,0	69,0	57,8	61 700	98 400
26,0	67,0	57,0	51 600	85 400
28,0	64,9	56,1	43 100	74 800
30,0	62,7	55,0	35 800	65 700
32,0	60,5	53,9	29 400	57 800
34,0	58,3	52,7	23 900	51 100
36,0	56,0	51,3	18 900	45 100
38,0	53,6	49,9	14 500	39 800
40,0	51,2	48,3	10 600	35 200
42,0	48,6	46,5	7 100	31 000
44,0	46,0	44,6		27 200
46,0	43,2	42,5		23 800
48,0	40,3	40,2		20 700
50,0	37,2	37,6		17 900
52,0	33,8	34,7		15 300
54,0	30,1	31,3		12 900

MLC300 VPC-MAX S-2

ASME B30.5

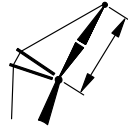
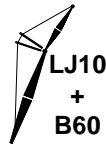

48,0 m



155°

66,0 m				
m	°	m	kg	kg
8,5	84,8	67,8	169 400	169 400
9,0	84,4	67,8	169 400	169 400
10,0	83,6	67,6	169 400	169 400
12,0	81,8	67,3	169 400	169 400
14,0	80,0	67,0	161 300	166 600
16,0	78,3	66,6	130 800	160 100
18,0	76,5	66,1	107 300	153 800
20,0	74,7	65,5	89 000	133 900
22,0	72,9	64,9	74 400	114 700
24,0	71,0	64,2	62 300	99 000
26,0	69,2	63,5	52 200	86 000
28,0	67,3	62,6	43 700	75 400
30,0	65,4	61,7	36 400	66 200
32,0	63,4	60,7	29 900	58 300
34,0	61,5	59,6	24 400	51 600
36,0	59,4	58,5	19 500	45 600
38,0	57,4	57,2	15 000	40 300
40,0	55,3	55,8	11 100	35 600
42,0	53,1	54,3	7 600	31 400
44,0	50,9	52,7		27 600
46,0	48,6	50,9		24 200
48,0	46,2	49,0		21 100
50,0	43,7	47,0		18 200
52,0	41,0	44,7		15 600
54,0	38,3	42,2		13 200
56,0	35,3	39,4		11 000
58,0	32,1	36,3		8 700
60,0	28,6	32,8		6 400

72,0 m				
m	°	m	kg	kg
9,1	84,8	73,8	150 200	150 200
10,0	84,1	73,7	150 200	150 200
12,0	82,5	73,4	147 400	147 400
14,0	80,9	73,1	142 100	142 100
16,0	79,3	72,7	129 600	136 600
18,0	77,6	72,3	107 100	131 200
20,0	76,0	71,8	88 700	125 700
22,0	74,3	71,2	74 200	114 600
24,0	72,7	70,6	62 000	98 900
26,0	71,0	69,9	51 900	85 900
28,0	69,3	69,1	43 400	75 200
30,0	67,6	68,3	36 000	66 100
32,0	65,8	67,4	29 600	58 100
34,0	64,1	66,4	24 000	51 400
36,0	62,3	65,4	19 100	45 400
38,0	60,4	64,3	14 600	40 100
40,0	58,6	63,0	10 700	35 400
42,0	56,7	61,7	7 100	31 200
44,0	54,7	60,3		27 300
46,0	52,7	58,8		23 900
48,0	50,7	57,2		20 800
50,0	48,5	55,4		17 900
52,0	46,4	53,5		15 300
54,0	44,1	51,5		12 900
56,0	41,7	49,3		10 500
58,0	39,2	46,8		8 000
60,0	36,6	44,2		5 700

MLC300 VPC-MAX S-2

ASME B30.5

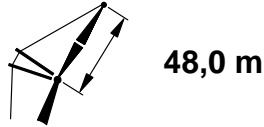
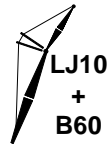

78,0 m				
m	°	m	10,6 m kg	14,6 m kg
9,8	84,7	79,8	120 800	120 800
10,0	84,6	79,7	120 800	120 800
12,0	83,1	79,5	120 800	120 800
14,0	81,6	79,2	120 200	120 200
16,0	80,1	78,8	116 600	116 600
18,0	78,6	78,4	106 400	114 800
20,0	77,1	78,0	89 000	113 500
22,0	75,6	77,5	74 400	110 500
24,0	74,0	76,9	62 200	99 200
26,0	72,5	76,2	52 000	86 200
28,0	71,0	75,6	43 500	75 500
30,0	69,4	74,8	36 100	66 300
32,0	67,8	74,0	29 700	58 300
34,0	66,2	73,1	24 100	51 500
36,0	64,6	72,2	19 100	45 500
38,0	62,9	71,1	14 700	40 200
40,0	61,2	70,0	10 700	35 500
42,0	59,5	68,9	7 200	31 200
44,0	57,8	67,6		27 400
46,0	56,0	66,3		24 000
48,0	54,2	64,8		20 800
50,0	52,4	63,3		18 000
52,0	50,5	61,7		15 300
54,0	48,5	59,9		12 900
56,0	46,5	58,0		10 400
58,0	44,4	56,0		7 800

84,0 m				
m	°	m	10,6 m kg	14,6 m kg
10,4	84,7	85,7	98 900	99 100
12,0	83,6	85,5	98 900	99 100
14,0	82,2	85,3	98 900	99 100
16,0	80,8	84,9	98 900	99 100
18,0	79,4	84,6	98 900	99 100
20,0	78,0	84,1	88 500	99 100
22,0	76,6	83,7	73 800	97 600
24,0	75,2	83,1	61 700	92 700
26,0	73,8	82,5	51 500	85 800
28,0	72,4	81,9	42 900	75 100
30,0	70,9	81,2	35 500	65 900
32,0	69,5	80,5	29 000	57 900
34,0	68,0	79,7	23 500	51 100
36,0	66,5	78,8	18 500	45 100
38,0	65,0	77,9	14 000	39 800
40,0	63,5	76,9	10 100	35 000
42,0	61,9	75,8	6 500	30 800
44,0	60,4	74,7		27 000
46,0	58,8	73,5		23 500
48,0	57,2	72,2		20 400
50,0	55,5	70,8		17 500
52,0	53,8	69,3		14 800
54,0	52,1	67,8		12 300
56,0	50,3	66,1		9 500
58,0	48,5	64,4		7 000

MLC300 VPC-MAX S-2

ASME B30.5

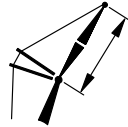
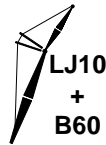

54,0 m



169°

42,0 m				
m	°	m	kg	kg
6,7	84,4	43,9	259 300	259 300
7,0	84,0	43,8	259 000	259 000
8,0	82,6	43,7	258 200	258 200
9,0	81,2	43,5	257 400	257 400
10,0	79,8	43,3	256 300	256 300
12,0	77,0	42,9	207 000	242 000
14,0	74,2	42,3	163 100	231 700
16,0	71,3	41,6	131 100	191 700
18,0	68,4	40,8	106 500	157 700
20,0	65,4	39,9	87 400	132 100
22,0	62,3	38,9	72 200	112 400
24,0	59,1	37,7	59 500	96 300
26,0	55,8	36,3	48 900	83 000
28,0	52,4	34,8	40 000	72 000
30,0	48,8	33,1	32 300	62 600
32,0	45,0	31,1	25 500	54 500
34,0	40,9	28,8	19 700	47 500
36,0	36,3	26,2	14 500	41 400
38,0	31,2	23,0	9 800	35 900
40,0	25,2	19,1		31 100

48,0 m				
m	°	m	kg	kg
7,3	84,4	49,8	237 200	237 200
8,0	83,5	49,8	236 800	236 800
9,0	82,3	49,6	236 200	236 200
10,0	81,1	49,4	235 800	235 800
12,0	78,7	49,0	209 200	232 200
14,0	76,2	48,5	165 100	220 100
16,0	73,7	48,0	133 000	193 600
18,0	71,2	47,3	108 400	159 500
20,0	68,7	46,5	89 200	133 900
22,0	66,1	45,6	74 000	114 000
24,0	63,4	44,6	61 300	97 900
26,0	60,6	43,5	50 600	84 500
28,0	57,8	42,2	41 700	73 500
30,0	54,9	40,8	34 000	64 100
32,0	51,9	39,3	27 200	56 000
34,0	48,7	37,6	21 400	49 000
36,0	45,4	35,6	16 100	42 800
38,0	41,9	33,4	11 500	37 300
40,0	38,0	30,9	7 300	32 500
42,0	33,8	28,0		28 100
44,0	29,1	24,6		24 200
46,0	23,4	20,3		20 600

MLC300 VPC-MAX S-2

ASME B30.5

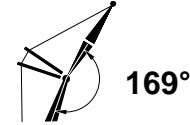
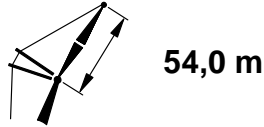
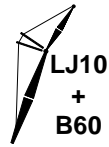

54,0 m				
m	°	m	10,6 m kg	14,6 m kg
7,3	85,0	55,9	214 600	214 600
8,0	84,3	55,8	214 300	214 300
9,0	83,2	55,7	214 000	214 000
10,0	82,1	55,5	213 800	213 800
12,0	80,0	55,2	208 300	213 400
14,0	77,8	54,7	167 000	206 200
16,0	75,6	54,2	134 900	193 400
18,0	73,4	53,6	110 300	161 200
20,0	71,1	52,9	91 000	135 500
22,0	68,9	52,2	75 800	115 600
24,0	66,6	51,3	63 000	99 400
26,0	64,2	50,3	52 400	86 000
28,0	61,8	49,3	43 400	75 000
30,0	59,3	48,1	35 700	65 600
32,0	56,8	46,8	28 900	57 400
34,0	54,2	45,4	23 100	50 400
36,0	51,5	43,8	17 900	44 200
38,0	48,7	42,0	13 200	38 700
40,0	45,7	40,1	9 000	33 900
42,0	42,6	38,0		29 500
44,0	39,3	35,6		25 500
46,0	35,7	32,8		22 000
48,0	31,8	29,7		18 700
50,0	27,3	26,0		15 700
52,0	22,0	21,4		13 000

60,0 m				
m	°	m	10,6 m kg	14,6 m kg
7,9	84,9	61,8	192 100	192 100
8,0	84,8	61,9	192 100	192 100
9,0	83,9	61,7	192 000	192 000
10,0	82,9	61,6	192 000	192 000
12,0	81,0	61,3	192 000	192 000
14,0	79,0	60,9	167 800	191 900
16,0	77,1	60,4	135 600	186 400
18,0	75,1	59,9	110 900	162 000
20,0	73,1	59,3	91 700	136 200
22,0	71,1	58,6	76 400	116 300
24,0	69,0	57,8	63 600	100 100
26,0	67,0	57,0	53 000	86 700
28,0	64,9	56,1	44 000	75 600
30,0	62,7	55,0	36 300	66 100
32,0	60,5	53,9	29 500	57 900
34,0	58,3	52,7	23 600	50 900
36,0	56,0	51,3	18 400	44 700
38,0	53,6	49,9	13 700	39 200
40,0	51,2	48,3	9 500	34 400
42,0	48,6	46,5	5 800	30 000
44,0	46,0	44,6		26 000
46,0	43,2	42,5		22 400
48,0	40,3	40,2		19 200
50,0	37,2	37,6		16 200
52,0	33,8	34,7		13 400
54,0	30,1	31,3		10 900
56,0	25,9	27,4		8 200

MLC300 VPC-MAX S-2

ASME B30.5

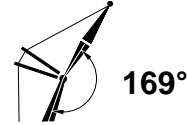
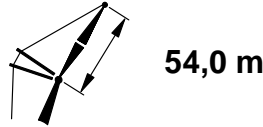
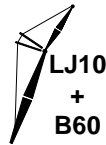

66,0 m				
m	o	m	kg	kg
8,5	84,8	67,8	170 900	170 900
9,0	84,4	67,8	170 900	170 900
10,0	83,6	67,6	170 900	170 900
12,0	81,8	67,3	170 900	170 900
14,0	80,0	67,0	165 900	169 200
16,0	78,3	66,6	136 700	162 700
18,0	76,5	66,1	111 900	156 400
20,0	74,7	65,5	92 600	137 200
22,0	72,9	64,9	77 300	117 200
24,0	71,0	64,2	64 600	100 900
26,0	69,2	63,5	53 900	87 500
28,0	67,3	62,6	44 900	76 400
30,0	65,4	61,7	37 200	67 000
32,0	63,4	60,7	30 400	58 700
34,0	61,5	59,6	24 500	51 700
36,0	59,4	58,5	19 300	45 500
38,0	57,4	57,2	14 600	40 000
40,0	55,3	55,8	10 400	35 100
42,0	53,1	54,3	6 700	30 700
44,0	50,9	52,7		26 800
46,0	48,6	50,9		23 200
48,0	46,2	49,0		19 900
50,0	43,7	47,0		16 900
52,0	41,0	44,7		14 200
54,0	38,3	42,2		11 600
56,0	35,3	39,4		8 900

72,0 m				
m	o	m	kg	kg
9,1	84,8	73,8	148 700	148 700
10,0	84,1	73,7	148 700	148 700
12,0	82,5	73,4	148 700	148 700
14,0	80,9	73,1	144 500	144 500
16,0	79,3	72,7	133 600	139 000
18,0	77,6	72,3	112 000	133 700
20,0	76,0	71,8	92 700	128 100
22,0	74,3	71,2	77 300	117 400
24,0	72,7	70,6	64 500	101 100
26,0	71,0	69,9	53 800	87 600
28,0	69,3	69,1	44 900	76 500
30,0	67,6	68,3	37 100	67 000
32,0	65,8	67,4	30 300	58 800
34,0	64,1	66,4	24 400	51 800
36,0	62,3	65,4	19 200	45 500
38,0	60,4	64,3	14 500	40 000
40,0	58,6	63,0	10 300	35 100
42,0	56,7	61,7	6 500	30 700
44,0	54,7	60,3		26 800
46,0	52,7	58,8		23 200
48,0	50,7	57,2		19 900
50,0	48,5	55,4		16 900
52,0	46,4	53,5		14 100
54,0	44,1	51,5		11 500
56,0	41,7	49,3		8 700

MLC300 VPC-MAX S-2

ASME B30.5

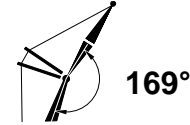
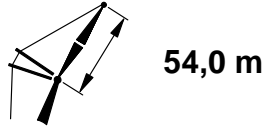
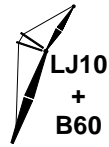

78,0 m				
m	°	m	10,6 m kg	14,6 m kg
9,8	84,7	79,8	119 200	119 200
10,0	84,6	79,7	119 200	119 200
12,0	83,1	79,5	119 200	119 200
14,0	81,6	79,2	119 200	119 200
16,0	80,1	78,8	118 400	118 400
18,0	78,6	78,4	110 800	116 600
20,0	77,1	78,0	93 100	115 100
22,0	75,6	77,5	77 700	112 500
24,0	74,0	76,9	64 900	101 500
26,0	72,5	76,2	54 200	88 000
28,0	71,0	75,6	45 200	76 900
30,0	69,4	74,8	37 400	67 400
32,0	67,8	74,0	30 600	59 100
34,0	66,2	73,1	24 700	52 100
36,0	64,6	72,2	19 500	45 900
38,0	62,9	71,1	14 800	40 300
40,0	61,2	70,0	10 600	35 400
42,0	59,5	68,9	6 800	31 000
44,0	57,8	67,6		27 100
46,0	56,0	66,3		23 500
48,0	54,2	64,8		20 200
50,0	52,4	63,3		17 200
52,0	50,5	61,7		14 400
54,0	48,5	59,9		11 700
56,0	46,5	58,0		8 800

84,0 m				
m	°	m	10,6 m kg	14,6 m kg
10,4	84,7	85,7	97 300	97 500
12,0	83,6	85,5	97 300	97 500
14,0	82,2	85,3	97 300	97 500
16,0	80,8	84,9	97 300	97 500
18,0	79,4	84,6	97 300	97 500
20,0	78,0	84,1	92 800	97 500
22,0	76,6	83,7	77 400	97 000
24,0	75,2	83,1	64 500	93 400
26,0	73,8	82,5	53 800	87 900
28,0	72,4	81,9	44 800	76 700
30,0	70,9	81,2	37 000	67 200
32,0	69,5	80,5	30 200	58 900
34,0	68,0	79,7	24 300	51 900
36,0	66,5	78,8	19 000	45 600
38,0	65,0	77,9	14 300	40 100
40,0	63,5	76,9	10 200	35 200
42,0	61,9	75,8	6 400	30 800
44,0	60,4	74,7		26 800
46,0	58,8	73,5		23 200
48,0	57,2	72,2		19 900
50,0	55,5	70,8		16 900
52,0	53,8	69,3		14 100
54,0	52,1	67,8		11 100
56,0	50,3	66,1		8 300

MLC300 VPC-MAX S-2

ASME B30.5

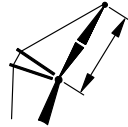
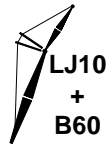

60,0 m



169°

42,0 m				
m	°	m	kg	kg
6,7	84,4	43,9	255 700	255 700
7,0	84,0	43,8	255 400	255 400
8,0	82,6	43,7	254 400	254 400
9,0	81,2	43,5	253 500	253 500
10,0	79,8	43,3	252 500	252 700
12,0	77,0	42,9	201 500	239 300
14,0	74,2	42,3	157 800	227 900
16,0	71,3	41,6	126 100	187 500
18,0	68,4	40,8	101 700	153 700
20,0	65,4	39,9	82 700	128 300
22,0	62,3	38,9	67 500	108 600
24,0	59,1	37,7	55 000	92 600
26,0	55,8	36,3	44 400	79 400
28,0	52,4	34,8	35 600	68 500
30,0	48,8	33,1	28 000	59 200
32,0	45,0	31,1	21 300	51 100
34,0	40,9	28,8	15 500	44 300
36,0	36,3	26,2	10 300	38 200
38,0	31,2	23,0	5 700	32 700
40,0	25,2	19,1		28 000

48,0 m				
m	°	m	kg	kg
7,3	84,4	49,8	233 800	233 800
8,0	83,5	49,8	233 400	233 400
9,0	82,3	49,6	232 700	232 700
10,0	81,1	49,4	232 200	232 200
12,0	78,7	49,0	203 900	229 400
14,0	76,2	48,5	160 200	220 700
16,0	73,7	48,0	128 300	189 700
18,0	71,2	47,3	103 900	155 800
20,0	68,7	46,5	84 800	130 300
22,0	66,1	45,6	69 700	110 600
24,0	63,4	44,6	57 100	94 500
26,0	60,6	43,5	46 500	81 200
28,0	57,8	42,2	37 600	70 300
30,0	54,9	40,8	30 000	60 900
32,0	51,9	39,3	23 200	52 800
34,0	48,7	37,6	17 400	45 900
36,0	45,4	35,6	12 300	39 800
38,0	41,9	33,4	7 700	34 300
40,0	38,0	30,9		29 500
42,0	33,8	28,0		25 200
44,0	29,1	24,6		21 300
46,0	23,4	20,3		17 800

MLC300 VPC-MAX S-2

ASME B30.5

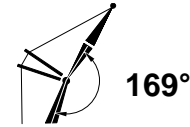
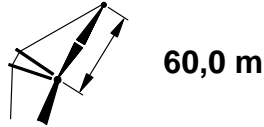
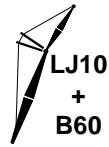

54,0 m				
m	°	m	10,6 m kg	14,6 m kg
7,3	85,0	55,9	211 500	211 500
8,0	84,3	55,8	211 200	211 200
9,0	83,2	55,7	210 800	210 800
10,0	82,1	55,5	210 500	210 500
12,0	80,0	55,2	203 800	210 000
14,0	77,8	54,7	162 300	203 900
16,0	75,6	54,2	130 400	190 300
18,0	73,4	53,6	105 900	157 700
20,0	71,1	52,9	86 900	132 100
22,0	68,9	52,2	71 700	112 300
24,0	66,6	51,3	59 100	96 200
26,0	64,2	50,3	48 500	82 900
28,0	61,8	49,3	39 600	72 000
30,0	59,3	48,1	31 900	62 600
32,0	56,8	46,8	25 200	54 500
34,0	54,2	45,4	19 400	47 500
36,0	51,5	43,8	14 200	41 400
38,0	48,7	42,0	9 600	35 900
40,0	45,7	40,1		31 100
42,0	42,6	38,0		26 800
44,0	39,3	35,6		22 800
46,0	35,7	32,8		19 300
48,0	31,8	29,7		16 100
50,0	27,3	26,0		13 100
52,0	22,0	21,4		10 400

60,0 m				
m	°	m	10,6 m kg	14,6 m kg
7,9	84,9	61,8	189 200	189 200
8,0	84,8	61,9	189 200	189 200
9,0	83,9	61,7	189 000	189 000
10,0	82,9	61,6	188 900	188 900
12,0	81,0	61,3	188 900	188 900
14,0	79,0	60,9	163 300	188 900
16,0	77,1	60,4	131 400	183 300
18,0	75,1	59,9	106 800	158 600
20,0	73,1	59,3	87 700	133 000
22,0	71,1	58,6	72 500	113 200
24,0	69,0	57,8	59 900	97 000
26,0	67,0	57,0	49 200	83 700
28,0	64,9	56,1	40 400	72 700
30,0	62,7	55,0	32 700	63 300
32,0	60,5	53,9	25 900	55 200
34,0	58,3	52,7	20 100	48 200
36,0	56,0	51,3	14 900	42 000
38,0	53,6	49,9	10 300	36 600
40,0	51,2	48,3		31 700
42,0	48,6	46,5		27 400
44,0	46,0	44,6		23 400
46,0	43,2	42,5		19 900
48,0	40,3	40,2		16 700
50,0	37,2	37,6		13 700
52,0	33,8	34,7		10 900
54,0	30,1	31,3		7 800

MLC300 VPC-MAX S-2

ASME B30.5

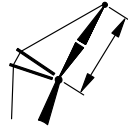
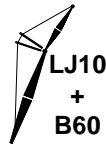

60,0 m



169°

66,0 m				
m	°	m	kg	kg
8,5	84,8	67,8	168 100	168 100
9,0	84,4	67,8	168 100	168 100
10,0	83,6	67,6	168 100	168 100
12,0	81,8	67,3	168 100	168 100
14,0	80,0	67,0	162 400	166 000
16,0	78,3	66,6	132 500	159 400
18,0	76,5	66,1	108 000	153 000
20,0	74,7	65,5	88 800	134 100
22,0	72,9	64,9	73 600	114 200
24,0	71,0	64,2	61 000	98 000
26,0	69,2	63,5	50 300	84 700
28,0	67,3	62,6	41 500	73 700
30,0	65,4	61,7	33 700	64 300
32,0	63,4	60,7	27 000	56 100
34,0	61,5	59,6	21 200	49 100
36,0	59,4	58,5	16 000	42 900
38,0	57,4	57,2	11 300	37 500
40,0	55,3	55,8	7 200	32 600
42,0	53,1	54,3		28 300
44,0	50,9	52,7		24 300
46,0	48,6	50,9		20 800
48,0	46,2	49,0		17 500
50,0	43,7	47,0		14 500
52,0	41,0	44,7		11 800
54,0	38,3	42,2		8 700
56,0	35,3	39,4		5 900

72,0 m				
m	°	m	kg	kg
9,1	84,8	73,8	146 000	146 000
10,0	84,1	73,7	146 000	146 000
12,0	82,5	73,4	145 400	145 400
14,0	80,9	73,1	140 400	140 400
16,0	79,3	72,7	129 600	135 000
18,0	77,6	72,3	108 100	129 600
20,0	76,0	71,8	89 000	124 200
22,0	74,3	71,2	73 700	114 500
24,0	72,7	70,6	61 000	98 300
26,0	71,0	69,9	50 400	84 900
28,0	69,3	69,1	41 500	73 900
30,0	67,6	68,3	33 800	64 400
32,0	65,8	67,4	27 000	56 200
34,0	64,1	66,4	21 200	49 300
36,0	62,3	65,4	16 000	43 100
38,0	60,4	64,3	11 300	37 600
40,0	58,6	63,0	7 200	32 700
42,0	56,7	61,7		28 400
44,0	54,7	60,3		24 400
46,0	52,7	58,8		20 800
48,0	50,7	57,2		17 600
50,0	48,5	55,4		14 600
52,0	46,4	53,5		11 600
54,0	44,1	51,5		8 600
56,0	41,7	49,3		5 700

MLC300 VPC-MAX S-2

ASME B30.5

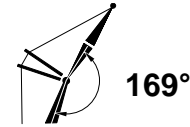
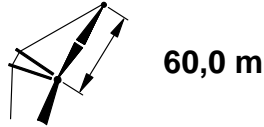
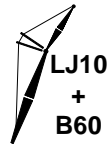

78,0 m				
m	°	m	10,6 m kg	14,6 m kg
9,8	84,7	79,8	116 600	116 600
10,0	84,6	79,7	116 600	116 600
12,0	83,1	79,5	116 600	116 600
14,0	81,6	79,2	116 600	116 600
16,0	80,1	78,8	115 500	115 500
18,0	78,6	78,4	107 200	113 500
20,0	77,1	78,0	89 500	112 000
22,0	75,6	77,5	74 300	109 400
24,0	74,0	76,9	61 500	98 700
26,0	72,5	76,2	50 900	85 400
28,0	71,0	75,6	42 000	74 400
30,0	69,4	74,8	34 200	64 900
32,0	67,8	74,0	27 500	56 700
34,0	66,2	73,1	21 600	49 700
36,0	64,6	72,2	16 400	43 500
38,0	62,9	71,1	11 800	38 000
40,0	61,2	70,0	7 600	33 100
42,0	59,5	68,9		28 700
44,0	57,8	67,6		24 800
46,0	56,0	66,3		21 200
48,0	54,2	64,8		18 000
50,0	52,4	63,3		15 000
52,0	50,5	61,7		11 900
54,0	48,5	59,9		8 800
56,0	46,5	58,0		6 000

84,0 m				
m	°	m	10,6 m kg	14,6 m kg
10,4	84,7	85,7	94 800	95 000
12,0	83,6	85,5	94 800	95 000
14,0	82,2	85,3	94 800	95 000
16,0	80,8	84,9	94 800	95 000
18,0	79,4	84,6	94 800	95 000
20,0	78,0	84,1	89 300	95 000
22,0	76,6	83,7	74 000	94 100
24,0	75,2	83,1	61 300	89 900
26,0	73,8	82,5	50 600	84 600
28,0	72,4	81,9	41 700	74 200
30,0	70,9	81,2	33 900	64 800
32,0	69,5	80,5	27 100	56 500
34,0	68,0	79,7	21 300	49 500
36,0	66,5	78,8	16 100	43 300
38,0	65,0	77,9	11 400	37 800
40,0	63,5	76,9	7 300	32 900
42,0	61,9	75,8		28 600
44,0	60,4	74,7		24 600
46,0	58,8	73,5		21 000
48,0	57,2	72,2		17 800
50,0	55,5	70,8		14 600
52,0	53,8	69,3		11 400
54,0	52,1	67,8		8 300
56,0	50,3	66,1		5 500

MLC300 VPC-MAX S-2

ASME B30.5

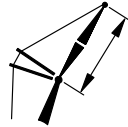

66,0 m



169°

42,0 m				
m	°	m	kg	kg
6,7	84,4	43,9	251 300	251 300
7,0	84,0	43,8	251 000	251 000
8,0	82,6	43,7	249 800	249 800
9,0	81,2	43,5	248 700	248 700
10,0	79,8	43,3	246 800	247 700
12,0	77,0	42,9	195 000	236 000
14,0	74,2	42,3	151 600	223 100
16,0	71,3	41,6	120 100	182 500
18,0	68,4	40,8	95 900	148 900
20,0	65,4	39,9	77 000	123 700
22,0	62,3	38,9	62 000	104 200
24,0	59,1	37,7	49 600	88 300
26,0	55,8	36,3	39 100	75 200
28,0	52,4	34,8	30 400	64 400
30,0	48,8	33,1	22 800	55 100
32,0	45,0	31,1	16 200	47 100
34,0	40,9	28,8	10 500	40 300
36,0	36,3	26,2		34 300
38,0	31,2	23,0		28 900
40,0	25,2	19,1		24 200

48,0 m				
m	°	m	kg	kg
7,3	84,4	49,8	229 800	229 800
8,0	83,5	49,8	229 200	229 300
9,0	82,3	49,6	228 500	228 500
10,0	81,1	49,4	227 800	227 800
12,0	78,7	49,0	197 800	225 900
14,0	76,2	48,5	154 300	220 600
16,0	73,7	48,0	122 700	185 000
18,0	71,2	47,3	98 500	151 300
20,0	68,7	46,5	79 500	126 000
22,0	66,1	45,6	64 500	106 400
24,0	63,4	44,6	52 000	90 400
26,0	60,6	43,5	41 500	77 300
28,0	57,8	42,2	32 800	66 400
30,0	54,9	40,8	25 100	57 100
32,0	51,9	39,3	18 500	49 100
34,0	48,7	37,6	12 800	42 200
36,0	45,4	35,6	7 600	36 200
38,0	41,9	33,4		30 800
40,0	38,0	30,9		26 000
42,0	33,8	28,0		21 700
44,0	29,1	24,6		17 900
46,0	23,4	20,3		14 400

MLC300 VPC-MAX S-2

ASME B30.5

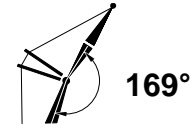
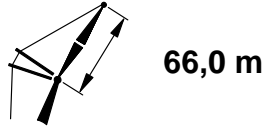
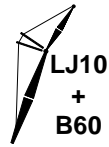

54,0 m				
m	°	m	10,6 m kg	14,6 m kg
7,3	85,0	55,9	207 700	207 700
8,0	84,3	55,8	207 300	207 300
9,0	83,2	55,7	206 900	206 900
10,0	82,1	55,5	206 500	206 500
12,0	80,0	55,2	198 500	205 800
14,0	77,8	54,7	156 700	202 300
16,0	75,6	54,2	125 100	186 000
18,0	73,4	53,6	100 800	153 400
20,0	71,1	52,9	81 900	128 000
22,0	68,9	52,2	66 800	108 400
24,0	66,6	51,3	54 300	92 400
26,0	64,2	50,3	43 800	79 200
28,0	61,8	49,3	35 000	68 300
30,0	59,3	48,1	27 400	59 000
32,0	56,8	46,8	20 700	50 900
34,0	54,2	45,4	15 000	44 000
36,0	51,5	43,8	9 800	38 000
38,0	48,7	42,0	5 200	32 500
40,0	45,7	40,1		27 800
42,0	42,6	38,0		23 500
44,0	39,3	35,6		19 600
46,0	35,7	32,8		16 100
48,0	31,8	29,7		12 900
50,0	27,3	26,0		9 600

60,0 m				
m	°	m	10,6 m kg	14,6 m kg
7,9	84,9	61,8	185 500	185 500
8,0	84,8	61,9	185 500	185 500
9,0	83,9	61,7	185 300	185 300
10,0	82,9	61,6	185 200	185 200
12,0	81,0	61,3	185 000	185 000
14,0	79,0	60,9	157 900	185 000
16,0	77,1	60,4	126 300	179 300
18,0	75,1	59,9	101 900	154 600
20,0	73,1	59,3	82 900	129 100
22,0	71,1	58,6	67 800	109 400
24,0	69,0	57,8	55 300	93 400
26,0	67,0	57,0	44 800	80 100
28,0	64,9	56,1	36 000	69 300
30,0	62,7	55,0	28 300	59 900
32,0	60,5	53,9	21 700	51 800
34,0	58,3	52,7	15 900	44 900
36,0	56,0	51,3	10 800	38 800
38,0	53,6	49,9	6 100	33 300
40,0	51,2	48,3		28 600
42,0	48,6	46,5		24 200
44,0	46,0	44,6		20 300
46,0	43,2	42,5		16 800
48,0	40,3	40,2		13 600
50,0	37,2	37,6		10 200
52,0	33,8	34,7		6 900

MLC300 VPC-MAX S-2

ASME B30.5

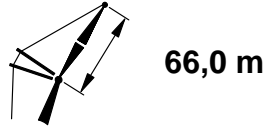
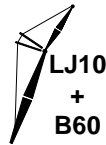

66,0 m

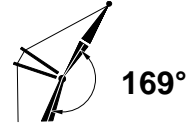

169°

66,0 m				
			10,6 m	14,6 m
m	°	m	kg	kg
8,5	84,8	67,8	164 600	164 600
9,0	84,4	67,8	164 600	164 600
10,0	83,6	67,6	164 600	164 600
12,0	81,8	67,3	164 600	164 600
14,0	80,0	67,0	157 400	160 900
16,0	78,3	66,6	127 600	154 300
18,0	76,5	66,1	103 200	147 900
20,0	74,7	65,5	84 200	130 300
22,0	72,9	64,9	69 100	110 600
24,0	71,0	64,2	56 600	94 500
26,0	69,2	63,5	46 100	81 300
28,0	67,3	62,6	37 200	70 400
30,0	65,4	61,7	29 600	61 000
32,0	63,4	60,7	22 900	52 900
34,0	61,5	59,6	17 100	46 000
36,0	59,4	58,5	12 000	39 800
38,0	57,4	57,2	7 400	34 400
40,0	55,3	55,8		29 600
42,0	53,1	54,3		25 300
44,0	50,9	52,7		21 300
46,0	48,6	50,9		17 800
48,0	46,2	49,0		14 600
50,0	43,7	47,0		11 300
52,0	41,0	44,7		8 000

72,0 m				
			10,6 m	14,6 m
m	°	m	kg	kg
9,1	84,8	73,8	142 700	142 700
10,0	84,1	73,7	142 700	142 700
12,0	82,5	73,4	141 700	141 700
14,0	80,9	73,1	136 600	136 600
16,0	79,3	72,7	125 300	131 000
18,0	77,6	72,3	103 600	125 700
20,0	76,0	71,8	84 500	120 200
22,0	74,3	71,2	69 400	110 900
24,0	72,7	70,6	56 800	94 900
26,0	71,0	69,9	46 300	81 600
28,0	69,3	69,1	37 500	70 700
30,0	67,6	68,3	29 800	61 300
32,0	65,8	67,4	23 100	53 200
34,0	64,1	66,4	17 300	46 200
36,0	62,3	65,4	12 200	40 100
38,0	60,4	64,3	7 500	34 600
40,0	58,6	63,0		29 800
42,0	56,7	61,7		25 500
44,0	54,7	60,3		21 500
46,0	52,7	58,8		18 000
48,0	50,7	57,2		14 700
50,0	48,5	55,4		11 300
52,0	46,4	53,5		8 000

MLC300 VPC-MAX S-2

ASME B30.5

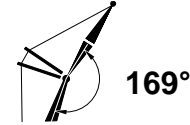
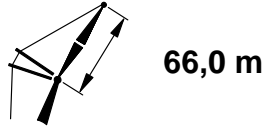
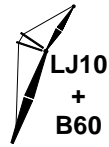

78,0 m				
m	°	m	10,6 m kg	14,6 m kg
9,8	84,7	79,8	113 200	113 200
10,0	84,6	79,7	113 200	113 200
12,0	83,1	79,5	113 200	113 200
14,0	81,6	79,2	112 900	112 900
16,0	80,1	78,8	110 700	110 700
18,0	78,6	78,4	102 700	108 700
20,0	77,1	78,0	85 200	107 200
22,0	75,6	77,5	70 100	104 800
24,0	74,0	76,9	57 500	95 200
26,0	72,5	76,2	46 900	82 200
28,0	71,0	75,6	38 000	71 300
30,0	69,4	74,8	30 400	61 900
32,0	67,8	74,0	23 700	53 700
34,0	66,2	73,1	17 900	46 700
36,0	64,6	72,2	12 700	40 600
38,0	62,9	71,1	8 100	35 100
40,0	61,2	70,0		30 300
42,0	59,5	68,9		26 000
44,0	57,8	67,6		22 000
46,0	56,0	66,3		18 500
48,0	54,2	64,8		15 100
50,0	52,4	63,3		11 600
52,0	50,5	61,7		8 300

84,0 m				
m	°	m	10,6 m kg	14,6 m kg
10,4	84,7	85,7	91 700	91 900
12,0	83,6	85,5	91 700	91 900
14,0	82,2	85,3	91 700	91 900
16,0	80,8	84,9	91 700	91 900
18,0	79,4	84,6	91 700	91 900
20,0	78,0	84,1	85 100	91 900
22,0	76,6	83,7	69 900	90 400
24,0	75,2	83,1	57 300	85 600
26,0	73,8	82,5	46 700	80 300
28,0	72,4	81,9	37 800	71 200
30,0	70,9	81,2	30 200	61 800
32,0	69,5	80,5	23 400	53 700
34,0	68,0	79,7	17 600	46 700
36,0	66,5	78,8	12 500	40 500
38,0	65,0	77,9	7 800	35 000
40,0	63,5	76,9		30 200
42,0	61,9	75,8		25 800
44,0	60,4	74,7		21 900
46,0	58,8	73,5		18 300
48,0	57,2	72,2		14 800
50,0	55,5	70,8		11 200
52,0	53,8	69,3		7 900

MLC300 VPC-MAX S-2

ASME B30.5

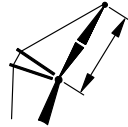
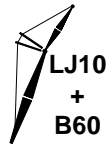

72,0 m



169°

42,0 m				
m	°	m	kg	kg
6,7	84,4	43,9	247 200	247 200
7,0	84,0	43,8	246 700	246 700
8,0	82,6	43,7	245 400	245 400
9,0	81,2	43,5	244 100	244 100
10,0	79,8	43,3	241 300	242 900
12,0	77,0	42,9	188 700	235 700
14,0	74,2	42,3	145 700	218 400
16,0	71,3	41,6	114 400	177 700
18,0	68,4	40,8	90 400	144 400
20,0	65,4	39,9	71 700	119 300
22,0	62,3	38,9	56 800	99 900
24,0	59,1	37,7	44 500	84 200
26,0	55,8	36,3	34 100	71 200
28,0	52,4	34,8	25 500	60 500
30,0	48,8	33,1	18 000	51 300
32,0	45,0	31,1	11 400	43 400
34,0	40,9	28,8		36 600
36,0	36,3	26,2		30 600
38,0	31,2	23,0		25 300
40,0	25,2	19,1		20 600

48,0 m				
m	°	m	kg	kg
7,3	84,4	49,8	225 800	225 800
8,0	83,5	49,8	225 200	225 200
9,0	82,3	49,6	224 300	224 300
10,0	81,1	49,4	223 500	223 500
12,0	78,7	49,0	191 800	222 100
14,0	76,2	48,5	148 700	216 300
16,0	73,7	48,0	117 400	180 500
18,0	71,2	47,3	93 300	147 000
20,0	68,7	46,5	74 600	121 900
22,0	66,1	45,6	59 700	102 400
24,0	63,4	44,6	47 300	86 600
26,0	60,6	43,5	36 900	73 500
28,0	57,8	42,2	28 200	62 800
30,0	54,9	40,8	20 600	53 600
32,0	51,9	39,3	14 000	45 600
34,0	48,7	37,6	8 400	38 800
36,0	45,4	35,6		32 800
38,0	41,9	33,4		27 400
40,0	38,0	30,9		22 700
42,0	33,8	28,0		18 500
44,0	29,1	24,6		14 700
46,0	23,4	20,3		10 900

MLC300 VPC-MAX S-2

ASME B30.5

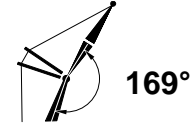
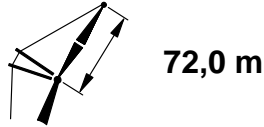
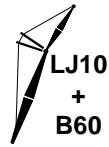

54,0 m				
m	°	m	kg	kg
7,3	85,0	55,9	204 000	204 000
8,0	84,3	55,8	203 600	203 600
9,0	83,2	55,7	203 000	203 000
10,0	82,1	55,5	202 600	202 600
12,0	80,0	55,2	193 400	201 700
14,0	77,8	54,7	151 400	200 100
16,0	75,6	54,2	120 100	182 000
18,0	73,4	53,6	96 000	149 400
20,0	71,1	52,9	77 200	124 200
22,0	68,9	52,2	62 200	104 700
24,0	66,6	51,3	49 800	88 800
26,0	64,2	50,3	39 400	75 700
28,0	61,8	49,3	30 700	64 900
30,0	59,3	48,1	23 100	55 700
32,0	56,8	46,8	16 500	47 600
34,0	54,2	45,4	10 800	40 800
36,0	51,5	43,8		34 800
38,0	48,7	42,0		29 400
40,0	45,7	40,1		24 700
42,0	42,6	38,0		20 400
44,0	39,3	35,6		16 500
46,0	35,7	32,8		13 000
48,0	31,8	29,7		9 200
50,0	27,3	26,0		5 700

60,0 m				
m	°	m	kg	kg
7,9	84,9	61,8	182 100	182 100
8,0	84,8	61,9	182 100	182 100
9,0	83,9	61,7	181 800	181 800
10,0	82,9	61,6	181 600	181 600
12,0	81,0	61,3	181 300	181 300
14,0	79,0	60,9	152 800	181 200
16,0	77,1	60,4	121 400	175 400
18,0	75,1	59,9	97 300	150 700
20,0	73,1	59,3	78 500	125 400
22,0	71,1	58,6	63 500	105 900
24,0	69,0	57,8	51 100	90 000
26,0	67,0	57,0	40 600	76 800
28,0	64,9	56,1	31 900	66 000
30,0	62,7	55,0	24 300	56 700
32,0	60,5	53,9	17 700	48 700
34,0	58,3	52,7	12 000	41 800
36,0	56,0	51,3	6 900	35 800
38,0	53,6	49,9		30 400
40,0	51,2	48,3		25 600
42,0	48,6	46,5		21 300
44,0	46,0	44,6		17 500
46,0	43,2	42,5		13 900
48,0	40,3	40,2		10 100
50,0	37,2	37,6		6 600

MLC300 VPC-MAX S-2

ASME B30.5

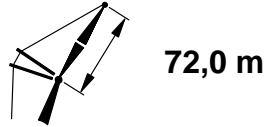
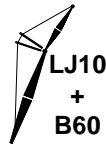

72,0 m

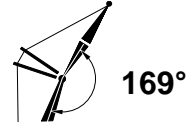

169°

66,0 m				
m	°	m	kg	kg
8,5	84,8	67,8	161 300	161 300
9,0	84,4	67,8	161 300	161 300
10,0	83,6	67,6	161 300	161 300
12,0	81,8	67,3	161 300	161 300
14,0	80,0	67,0	153 300	157 000
16,0	78,3	66,6	123 000	150 400
18,0	76,5	66,1	98 800	143 900
20,0	74,7	65,5	79 900	126 800
22,0	72,9	64,9	65 000	107 200
24,0	71,0	64,2	52 500	91 300
26,0	69,2	63,5	42 100	78 100
28,0	67,3	62,6	33 300	67 300
30,0	65,4	61,7	25 800	58 000
32,0	63,4	60,7	19 100	49 900
34,0	61,5	59,6	13 400	43 000
36,0	59,4	58,5	8 300	37 000
38,0	57,4	57,2		31 600
40,0	55,3	55,8		26 800
42,0	53,1	54,3		22 500
44,0	50,9	52,7		18 600
46,0	48,6	50,9		15 000
48,0	46,2	49,0		11 300
50,0	43,7	47,0		7 800

72,0 m				
m	°	m	kg	kg
9,1	84,8	73,8	139 500	139 500
10,0	84,1	73,7	139 500	139 500
12,0	82,5	73,4	138 100	138 100
14,0	80,9	73,1	132 800	132 800
16,0	79,3	72,7	121 200	127 300
18,0	77,6	72,3	99 300	121 800
20,0	76,0	71,8	80 400	116 400
22,0	74,3	71,2	65 400	107 300
24,0	72,7	70,6	52 900	91 800
26,0	71,0	69,9	42 500	78 600
28,0	69,3	69,1	33 700	67 700
30,0	67,6	68,3	26 100	58 400
32,0	65,8	67,4	19 500	50 300
34,0	64,1	66,4	13 700	43 400
36,0	62,3	65,4	8 600	37 300
38,0	60,4	64,3		31 900
40,0	58,6	63,0		27 100
42,0	56,7	61,7		22 800
44,0	54,7	60,3		18 900
46,0	52,7	58,8		15 300
48,0	50,7	57,2		11 500
50,0	48,5	55,4		7 900

MLC300 VPC-MAX S-2

ASME B30.5

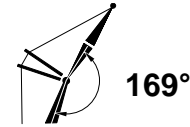
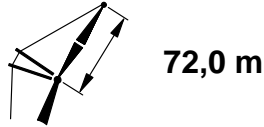
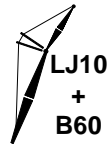

78,0 m				
m	°	m	10,6 m kg	14,6 m kg
9,8	84,7	79,8	110 100	110 100
10,0	84,6	79,7	110 100	110 100
12,0	83,1	79,5	110 100	110 100
14,0	81,6	79,2	109 700	109 700
16,0	80,1	78,8	107 000	107 000
18,0	78,6	78,4	98 600	105 000
20,0	77,1	78,0	81 200	103 500
22,0	75,6	77,5	66 200	100 800
24,0	74,0	76,9	53 700	91 900
26,0	72,5	76,2	43 200	79 300
28,0	71,0	75,6	34 400	68 400
30,0	69,4	74,8	26 800	59 100
32,0	67,8	74,0	20 200	51 000
34,0	66,2	73,1	14 400	44 100
36,0	64,6	72,2	9 300	37 900
38,0	62,9	71,1	4 700	32 500
40,0	61,2	70,0		27 700
42,0	59,5	68,9		23 400
44,0	57,8	67,6		19 500
46,0	56,0	66,3		15 800
48,0	54,2	64,8		12 000
50,0	52,4	63,3		8 400

84,0 m				
m	°	m	10,6 m kg	14,6 m kg
10,4	84,7	85,7	88 700	88 900
12,0	83,6	85,5	88 700	88 900
14,0	82,2	85,3	88 700	88 900
16,0	80,8	84,9	88 700	88 900
18,0	79,4	84,6	88 700	88 900
20,0	78,0	84,1	81 200	88 800
22,0	76,6	83,7	66 100	86 600
24,0	75,2	83,1	53 600	81 500
26,0	73,8	82,5	43 100	76 300
28,0	72,4	81,9	34 300	68 500
30,0	70,9	81,2	26 700	59 100
32,0	69,5	80,5	20 100	51 000
34,0	68,0	79,7	14 300	44 100
36,0	66,5	78,8	9 200	38 000
38,0	65,0	77,9		32 500
40,0	63,5	76,9		27 700
42,0	61,9	75,8		23 400
44,0	60,4	74,7		19 500
46,0	58,8	73,5		15 500
48,0	57,2	72,2		11 700
50,0	55,5	70,8		8 100

MLC300 VPC-MAX S-2

ASME B30.5

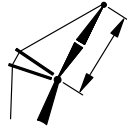
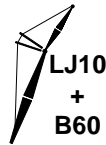

78,0 m



169°

42,0 m				
m	°	m	kg	kg
6,7	84,4	43,9	242 300	242 300
7,0	84,0	43,8	241 900	241 900
8,0	82,6	43,7	240 300	240 300
9,0	81,2	43,5	238 800	238 800
10,0	79,8	43,3	235 000	237 400
12,0	77,0	42,9	181 600	234 700
14,0	74,2	42,3	138 900	213 000
16,0	71,3	41,6	108 000	172 200
18,0	68,4	40,8	84 100	139 200
20,0	65,4	39,9	65 600	114 300
22,0	62,3	38,9	50 900	95 100
24,0	59,1	37,7	38 600	79 500
26,0	55,8	36,3	28 400	66 600
28,0	52,4	34,8	19 800	56 000
30,0	48,8	33,1	12 400	46 900
32,0	45,0	31,1	5 900	39 000
34,0	40,9	28,8		32 300
36,0	36,3	26,2		26 400
38,0	31,2	23,0		21 200
40,0	25,2	19,1		16 200

48,0 m				
m	°	m	kg	kg
7,3	84,4	49,8	221 300	221 300
8,0	83,5	49,8	220 500	220 500
9,0	82,3	49,6	219 500	219 500
10,0	81,1	49,4	218 600	218 600
12,0	78,7	49,0	185 100	216 800
14,0	76,2	48,5	142 400	210 900
16,0	73,7	48,0	111 300	175 400
18,0	71,2	47,3	87 400	142 200
20,0	68,7	46,5	68 900	117 200
22,0	66,1	45,6	54 100	97 900
24,0	63,4	44,6	41 800	82 200
26,0	60,6	43,5	31 500	69 300
28,0	57,8	42,2	22 900	58 600
30,0	54,9	40,8	15 400	49 500
32,0	51,9	39,3	8 900	41 600
34,0	48,7	37,6		34 800
36,0	45,4	35,6		28 800
38,0	41,9	33,4		23 500
40,0	38,0	30,9		18 900
42,0	33,8	28,0		14 600
44,0	29,1	24,6		10 300

MLC300 VPC-MAX S-2

ASME B30.5

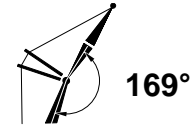
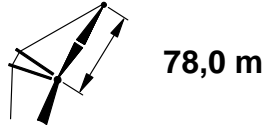
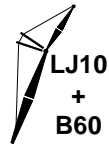

54,0 m				
m	°	m	10,6 m kg	14,6 m kg
7,3	85,0	55,9	199 800	199 800
8,0	84,3	55,8	199 400	199 400
9,0	83,2	55,7	198 700	198 700
10,0	82,1	55,5	198 100	198 100
12,0	80,0	55,2	187 600	197 100
14,0	77,8	54,7	145 400	195 400
16,0	75,6	54,2	114 300	177 400
18,0	73,4	53,6	90 400	144 800
20,0	71,1	52,9	71 800	119 800
22,0	68,9	52,2	57 000	100 400
24,0	66,6	51,3	44 700	84 700
26,0	64,2	50,3	34 400	71 700
28,0	61,8	49,3	25 700	61 000
30,0	59,3	48,1	18 200	51 800
32,0	56,8	46,8	11 700	43 800
34,0	54,2	45,4		37 100
36,0	51,5	43,8		31 100
38,0	48,7	42,0		25 700
40,0	45,7	40,1		21 100
42,0	42,6	38,0		16 800
44,0	39,3	35,6		12 700
46,0	35,7	32,8		8 500

60,0 m				
m	°	m	10,6 m kg	14,6 m kg
7,9	84,9	61,8	178 000	178 000
8,0	84,8	61,9	178 000	178 000
9,0	83,9	61,7	177 700	177 700
10,0	82,9	61,6	177 400	177 400
12,0	81,0	61,3	177 000	177 000
14,0	79,0	60,9	147 000	176 700
16,0	77,1	60,4	115 900	170 800
18,0	75,1	59,9	91 900	146 400
20,0	73,1	59,3	73 300	121 200
22,0	71,1	58,6	58 500	101 800
24,0	69,0	57,8	46 100	86 000
26,0	67,0	57,0	35 800	73 000
28,0	64,9	56,1	27 200	62 300
30,0	62,7	55,0	19 700	53 100
32,0	60,5	53,9	13 100	45 100
34,0	58,3	52,7	7 500	38 300
36,0	56,0	51,3		32 300
38,0	53,6	49,9		26 900
40,0	51,2	48,3		22 200
42,0	48,6	46,5		18 000
44,0	46,0	44,6		13 800
46,0	43,2	42,5		9 600

MLC300 VPC-MAX S-2

ASME B30.5

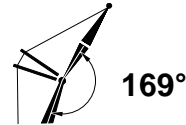
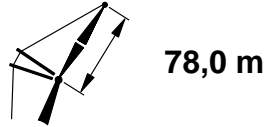

66,0 m				
			10,6 m	14,6 m
m	°	m	kg	kg
8,5	84,8	67,8	157 300	157 300
9,0	84,4	67,8	157 300	157 300
10,0	83,6	67,6	157 300	157 300
12,0	81,8	67,3	157 200	157 200
14,0	80,0	67,0	148 600	152 400
16,0	78,3	66,6	117 600	145 800
18,0	76,5	66,1	93 700	139 300
20,0	74,7	65,5	75 000	122 800
22,0	72,9	64,9	60 200	103 300
24,0	71,0	64,2	47 800	87 500
26,0	69,2	63,5	37 500	74 400
28,0	67,3	62,6	28 800	63 700
30,0	65,4	61,7	21 300	54 500
32,0	63,4	60,7	14 700	46 500
34,0	61,5	59,6	9 100	39 600
36,0	59,4	58,5		33 600
38,0	57,4	57,2		28 200
40,0	55,3	55,8		23 500
42,0	53,1	54,3		19 300
44,0	50,9	52,7		15 200
46,0	48,6	50,9		11 000
48,0	46,2	49,0		7 200

72,0 m				
			10,6 m	14,6 m
m	°	m	kg	kg
9,1	84,8	73,8	135 700	135 700
10,0	84,1	73,7	135 700	135 700
12,0	82,5	73,4	133 700	133 700
14,0	80,9	73,1	128 400	128 400
16,0	79,3	72,7	116 500	122 900
18,0	77,6	72,3	94 300	117 400
20,0	76,0	71,8	75 600	111 900
22,0	74,3	71,2	60 700	103 200
24,0	72,7	70,6	48 400	88 100
26,0	71,0	69,9	38 000	75 000
28,0	69,3	69,1	29 400	64 300
30,0	67,6	68,3	21 800	55 000
32,0	65,8	67,4	15 200	47 000
34,0	64,1	66,4	9 600	40 200
36,0	62,3	65,4		34 100
38,0	60,4	64,3		28 700
40,0	58,6	63,0		24 000
42,0	56,7	61,7		19 700
44,0	54,7	60,3		15 500
46,0	52,7	58,8		11 300
48,0	50,7	57,2		7 500

MLC300 VPC-MAX S-2

ASME B30.5

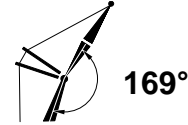
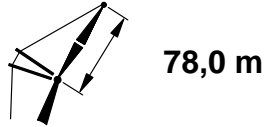
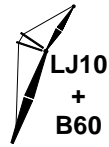

78,0 m				
m	°	m	10,6 m kg	14,6 m kg
9,8	84,7	79,8	106 300	106 300
10,0	84,6	79,7	106 300	106 300
12,0	83,1	79,5	106 300	106 300
14,0	81,6	79,2	105 800	105 800
16,0	80,1	78,8	102 800	102 800
18,0	78,6	78,4	94 000	100 800
20,0	77,1	78,0	76 600	99 200
22,0	75,6	77,5	61 700	96 200
24,0	74,0	76,9	49 300	88 000
26,0	72,5	76,2	38 900	75 900
28,0	71,0	75,6	30 200	65 100
30,0	69,4	74,8	22 700	55 800
32,0	67,8	74,0	16 100	47 800
34,0	66,2	73,1	10 400	40 900
36,0	64,6	72,2		34 800
38,0	62,9	71,1		29 400
40,0	61,2	70,0		24 700
42,0	59,5	68,9		20 400
44,0	57,8	67,6		16 100
46,0	56,0	66,3		11 900
48,0	54,2	64,8		8 100

84,0 m				
m	°	m	10,6 m kg	14,6 m kg
10,4	84,7	85,7	85 100	85 300
12,0	83,6	85,5	85 100	85 300
14,0	82,2	85,3	85 100	85 300
16,0	80,8	84,9	85 100	85 300
18,0	79,4	84,6	85 100	85 300
20,0	78,0	84,1	76 700	85 100
22,0	76,6	83,7	61 800	81 800
24,0	75,2	83,1	49 400	76 700
26,0	73,8	82,5	39 000	71 600
28,0	72,4	81,9	30 300	65 200
30,0	70,9	81,2	22 700	55 900
32,0	69,5	80,5	16 100	47 900
34,0	68,0	79,7	10 400	41 000
36,0	66,5	78,8		35 000
38,0	65,0	77,9		29 500
40,0	63,5	76,9		24 800
42,0	61,9	75,8		20 400
44,0	60,4	74,7		15 900
46,0	58,8	73,5		11 800
48,0	57,2	72,2		7 900

MLC300 VPC-MAX S-2

ASME B30.5

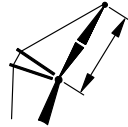
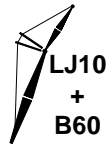

84,0 m



169°

42,0 m				
m	°	m	kg	kg
6,7	84,4	43,9	237 800	237 800
7,0	84,0	43,8	237 300	237 300
8,0	82,6	43,7	235 500	235 500
9,0	81,2	43,5	233 900	233 900
10,0	79,8	43,3	229 100	232 300
12,0	77,0	42,9	174 900	229 400
14,0	74,2	42,3	132 600	208 000
16,0	71,3	41,6	101 900	167 100
18,0	68,4	40,8	78 300	134 300
20,0	65,4	39,9	59 900	109 600
22,0	62,3	38,9	45 300	90 600
24,0	59,1	37,7	33 200	75 100
26,0	55,8	36,3	23 100	62 300
28,0	52,4	34,8	14 600	51 800
30,0	48,8	33,1	7 200	42 800
32,0	45,0	31,1		35 000
34,0	40,9	28,8		28 400
36,0	36,3	26,2		22 600
38,0	31,2	23,0		17 400
40,0	25,2	19,1		12 100

48,0 m				
m	°	m	kg	kg
7,3	84,4	49,8	217 000	217 000
8,0	83,5	49,8	216 200	216 200
9,0	82,3	49,6	215 000	215 100
10,0	81,1	49,4	214 000	214 000
12,0	78,7	49,0	178 800	212 000
14,0	76,2	48,5	136 400	205 800
16,0	73,7	48,0	105 600	170 500
18,0	71,2	47,3	82 000	137 600
20,0	68,7	46,5	63 600	112 900
22,0	66,1	45,6	48 900	93 700
24,0	63,4	44,6	36 800	78 100
26,0	60,6	43,5	26 600	65 300
28,0	57,8	42,2	18 000	54 700
30,0	54,9	40,8	10 700	45 700
32,0	51,9	39,3		37 800
34,0	48,7	37,6		31 100
36,0	45,4	35,6		25 200
38,0	41,9	33,4		20 000
40,0	38,0	30,9		15 300
42,0	33,8	28,0		10 300
44,0	29,1	24,6		5 800

MLC300 VPC-MAX S-2

ASME B30.5

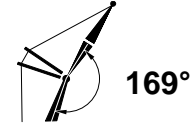
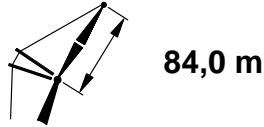
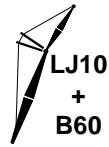

54,0 m				
m	°	m	10,6 m kg	14,6 m kg
7,3	85,0	55,9	195 800	195 800
8,0	84,3	55,8	195 300	195 300
9,0	83,2	55,7	194 600	194 600
10,0	82,1	55,5	193 900	193 900
12,0	80,0	55,2	182 100	192 700
14,0	77,8	54,7	139 700	190 900
16,0	75,6	54,2	108 900	173 100
18,0	73,4	53,6	85 200	140 500
20,0	71,1	52,9	66 800	115 700
22,0	68,9	52,2	52 100	96 500
24,0	66,6	51,3	39 900	80 800
26,0	64,2	50,3	29 700	67 900
28,0	61,8	49,3	21 200	57 300
30,0	59,3	48,1	13 800	48 200
32,0	56,8	46,8	7 300	40 400
34,0	54,2	45,4		33 600
36,0	51,5	43,8		27 700
38,0	48,7	42,0		22 400
40,0	45,7	40,1		17 700
42,0	42,6	38,0		13 100
44,0	39,3	35,6		8 500

60,0 m				
m	°	m	10,6 m kg	14,6 m kg
7,9	84,9	61,8	174 200	174 200
8,0	84,8	61,9	174 100	174 100
9,0	83,9	61,7	173 800	173 800
10,0	82,9	61,6	173 500	173 500
12,0	81,0	61,3	173 000	173 000
14,0	79,0	60,9	141 600	172 500
16,0	77,1	60,4	110 700	166 400
18,0	75,1	59,9	87 000	142 300
20,0	73,1	59,3	68 500	117 400
22,0	71,1	58,6	53 900	98 100
24,0	69,0	57,8	41 600	82 400
26,0	67,0	57,0	31 400	69 500
28,0	64,9	56,1	22 800	58 800
30,0	62,7	55,0	15 400	49 700
32,0	60,5	53,9	8 900	41 800
34,0	58,3	52,7		35 000
36,0	56,0	51,3		29 100
38,0	53,6	49,9		23 800
40,0	51,2	48,3		19 100
42,0	48,6	46,5		14 400
44,0	46,0	44,6		9 800

MLC300 VPC-MAX S-2

ASME B30.5

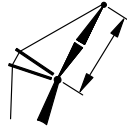
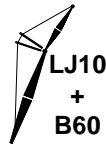

84,0 m



169°

66,0 m				
m	°	m	kg	kg
8,5	84,8	67,8	153 600	153 600
9,0	84,4	67,8	153 600	153 600
10,0	83,6	67,6	153 500	153 500
12,0	81,8	67,3	153 500	153 500
14,0	80,0	67,0	143 600	148 100
16,0	78,3	66,6	112 700	141 500
18,0	76,5	66,1	88 900	135 000
20,0	74,7	65,5	70 400	119 100
22,0	72,9	64,9	55 700	99 800
24,0	71,0	64,2	43 500	84 000
26,0	69,2	63,5	33 300	71 100
28,0	67,3	62,6	24 700	60 400
30,0	65,4	61,7	17 300	51 200
32,0	63,4	60,7	10 800	43 300
34,0	61,5	59,6		36 600
36,0	59,4	58,5		30 600
38,0	57,4	57,2		25 300
40,0	55,3	55,8		20 600
42,0	53,1	54,3		16 000
44,0	50,9	52,7		11 400
46,0	48,6	50,9		7 300

72,0 m				
m	°	m	kg	kg
9,1	84,8	73,8	132 000	132 000
10,0	84,1	73,7	132 000	132 000
12,0	82,5	73,4	129 600	129 600
14,0	80,9	73,1	124 300	124 300
16,0	79,3	72,7	112 100	118 800
18,0	77,6	72,3	89 800	113 300
20,0	76,0	71,8	71 200	107 800
22,0	74,3	71,2	56 500	99 300
24,0	72,7	70,6	44 300	84 800
26,0	71,0	69,9	34 000	71 800
28,0	69,3	69,1	25 400	61 100
30,0	67,6	68,3	17 900	51 900
32,0	65,8	67,4	11 400	44 000
34,0	64,1	66,4		37 200
36,0	62,3	65,4		31 200
38,0	60,4	64,3		25 900
40,0	58,6	63,0		21 100
42,0	56,7	61,7		16 500
44,0	54,7	60,3		11 900
46,0	52,7	58,8		7 700

MLC300 VPC-MAX S-2

ASME B30.5

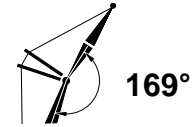
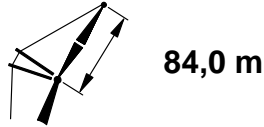
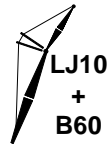

84,0 m				
78,0 m				
m	°	m	10,6 m kg	14,6 m kg
9,8	84,7	79,8	102 700	102 700
10,0	84,6	79,7	102 700	102 700
12,0	83,1	79,5	102 700	102 700
14,0	81,6	79,2	102 100	102 100
16,0	80,1	78,8	98 800	98 800
18,0	78,6	78,4	89 700	96 800
20,0	77,1	78,0	72 300	95 100
22,0	75,6	77,5	57 600	91 700
24,0	74,0	76,9	45 300	84 500
26,0	72,5	76,2	35 000	72 800
28,0	71,0	75,6	26 400	62 000
30,0	69,4	74,8	18 900	52 800
32,0	67,8	74,0	12 400	44 900
34,0	66,2	73,1		38 100
36,0	64,6	72,2		32 000
38,0	62,9	71,1		26 700
40,0	61,2	70,0		21 900
42,0	59,5	68,9		17 200
44,0	57,8	67,6		12 600
46,0	56,0	66,3		8 500

84,0 m				
m	°	m	10,6 m kg	14,6 m kg
10,4	84,7	85,7	81 500	81 600
12,0	83,6	85,5	81 500	81 600
14,0	82,2	85,3	81 500	81 600
16,0	80,8	84,9	81 500	81 600
18,0	79,4	84,6	81 500	81 600
20,0	78,0	84,1	72 600	80 800
22,0	76,6	83,7	57 800	77 500
24,0	75,2	83,1	45 500	72 400
26,0	73,8	82,5	35 200	67 300
28,0	72,4	81,9	26 600	61 400
30,0	70,9	81,2	19 100	53 100
32,0	69,5	80,5	12 500	45 100
34,0	68,0	79,7		38 300
36,0	66,5	78,8		32 200
38,0	65,0	77,9		26 900
40,0	63,5	76,9		22 000
42,0	61,9	75,8		17 100
44,0	60,4	74,7		12 500
46,0	58,8	73,5		8 400

MLC300 VPC-MAX S-2

ASME B30.5

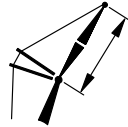
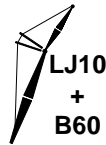

90,0 m



169°

42,0 m				
m	°	m	kg	kg
6,7	84,4	43,9	232 400	232 500
7,0	84,0	43,8	231 800	231 900
8,0	82,6	43,7	229 800	229 900
9,0	81,2	43,5	228 000	228 000
10,0	79,8	43,3	222 200	226 200
12,0	77,0	42,9	167 200	222 900
14,0	74,2	42,3	125 300	202 200
16,0	71,3	41,6	94 900	161 200
18,0	68,4	40,8	71 500	128 700
20,0	65,4	39,9	53 400	104 200
22,0	62,3	38,9	38 900	85 400
24,0	59,1	37,7	26 900	70 000
26,0	55,8	36,3	16 900	57 400
28,0	52,4	34,8	8 500	47 000
30,0	48,8	33,1		38 100
32,0	45,0	31,1		30 400
34,0	40,9	28,8		23 800
36,0	36,3	26,2		18 000
38,0	31,2	23,0		12 100

48,0 m				
m	°	m	kg	kg
7,3	84,4	49,8	212 000	212 000
8,0	83,5	49,8	211 100	211 100
9,0	82,3	49,6	209 800	209 800
10,0	81,1	49,4	208 600	208 600
12,0	78,7	49,0	171 500	206 300
14,0	76,2	48,5	129 600	199 900
16,0	73,7	48,0	99 100	165 000
18,0	71,2	47,3	75 700	132 400
20,0	68,7	46,5	57 400	107 800
22,0	66,1	45,6	42 900	88 900
24,0	63,4	44,6	30 900	73 400
26,0	60,6	43,5	20 800	60 700
28,0	57,8	42,2	12 400	50 200
30,0	54,9	40,8		41 300
32,0	51,9	39,3		33 500
34,0	48,7	37,6		26 900
36,0	45,4	35,6		21 000
38,0	41,9	33,4		15 500
40,0	38,0	30,9		10 000

MLC300 VPC-MAX S-2

ASME B30.5

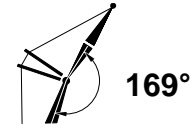
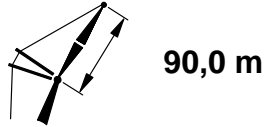
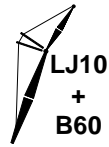

54,0 m				
m	°	m	10,6 m kg	14,6 m kg
7,3	85,0	55,9	191 000	191 000
8,0	84,3	55,8	190 400	190 400
9,0	83,2	55,7	189 600	189 600
10,0	82,1	55,5	188 800	188 800
12,0	80,0	55,2	175 200	187 400
14,0	77,8	54,7	133 200	185 600
16,0	75,6	54,2	102 700	168 100
18,0	73,4	53,6	79 200	135 500
20,0	71,1	52,9	61 000	110 900
22,0	68,9	52,2	46 500	91 900
24,0	66,6	51,3	34 400	76 400
26,0	64,2	50,3	24 300	63 600
28,0	61,8	49,3	15 800	53 100
30,0	59,3	48,1	8 500	44 100
32,0	56,8	46,8		36 300
34,0	54,2	45,4		29 600
36,0	51,5	43,8		23 700
38,0	48,7	42,0		18 500
40,0	45,7	40,1		13 000
42,0	42,6	38,0		8 000

60,0 m				
m	°	m	10,6 m kg	14,6 m kg
7,9	84,9	61,8	169 500	169 500
8,0	84,8	61,9	169 500	169 500
9,0	83,9	61,7	169 100	169 100
10,0	82,9	61,6	168 700	168 700
12,0	81,0	61,3	168 100	168 100
14,0	79,0	60,9	135 300	167 400
16,0	77,1	60,4	104 800	161 300
18,0	75,1	59,9	81 300	137 500
20,0	73,1	59,3	63 000	112 800
22,0	71,1	58,6	48 500	93 700
24,0	69,0	57,8	36 400	78 200
26,0	67,0	57,0	26 300	65 400
28,0	64,9	56,1	17 800	54 800
30,0	62,7	55,0	10 400	45 800
32,0	60,5	53,9		37 900
34,0	58,3	52,7		31 200
36,0	56,0	51,3		25 300
38,0	53,6	49,9		20 100
40,0	51,2	48,3		14 700
42,0	48,6	46,5		9 700
44,0	46,0	44,6		5 100

MLC300 VPC-MAX S-2

ASME B30.5

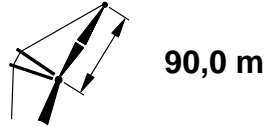
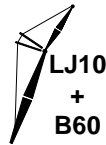

90,0 m

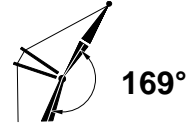

169°

66,0 m				
m	°	m	kg	kg
8,5	84,8	67,8	149 100	149 100
9,0	84,4	67,8	149 100	149 100
10,0	83,6	67,6	149 000	149 000
12,0	81,8	67,3	148 100	148 100
14,0	80,0	67,0	137 500	142 000
16,0	78,3	66,6	106 900	135 300
18,0	76,5	66,1	83 400	128 800
20,0	74,7	65,5	65 100	114 700
22,0	72,9	64,9	50 600	95 600
24,0	71,0	64,2	38 500	80 000
26,0	69,2	63,5	28 300	67 100
28,0	67,3	62,6	19 800	56 600
30,0	65,4	61,7	12 500	47 500
32,0	63,4	60,7	6 100	39 600
34,0	61,5	59,6		32 900
36,0	59,4	58,5		27 000
38,0	57,4	57,2		21 700
40,0	55,3	55,8		16 500
42,0	53,1	54,3		11 500
44,0	50,9	52,7		6 900

72,0 m				
m	°	m	kg	kg
9,1	84,8	73,8	127 400	127 400
10,0	84,1	73,7	127 400	127 400
12,0	82,5	73,4	123 700	123 700
14,0	80,9	73,1	118 500	118 500
16,0	79,3	72,7	106 400	112 900
18,0	77,6	72,3	84 400	107 500
20,0	76,0	71,8	66 100	101 900
22,0	74,3	71,2	51 500	94 300
24,0	72,7	70,6	39 400	80 900
26,0	71,0	69,9	29 200	68 000
28,0	69,3	69,1	20 700	57 400
30,0	67,6	68,3	13 400	48 300
32,0	65,8	67,4	6 900	40 400
34,0	64,1	66,4		33 700
36,0	62,3	65,4		27 800
38,0	60,4	64,3		22 500
40,0	58,6	63,0		17 100
42,0	56,7	61,7		12 100
44,0	54,7	60,3		7 500

MLC300 VPC-MAX S-2

ASME B30.5

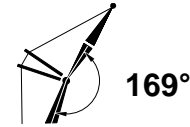
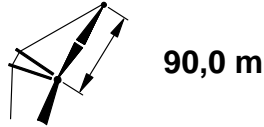
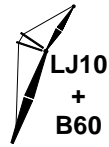

78,0 m				
m	°	m	10,6 m kg	14,6 m kg
9,8	84,7	79,8	98 200	98 300
10,0	84,6	79,7	98 200	98 300
12,0	83,1	79,5	98 200	98 300
14,0	81,6	79,2	97 600	97 600
16,0	80,1	78,8	94 000	94 000
18,0	78,6	78,4	84 600	91 900
20,0	77,1	78,0	67 400	90 200
22,0	75,6	77,5	52 700	86 100
24,0	74,0	76,9	40 600	79 900
26,0	72,5	76,2	30 400	69 100
28,0	71,0	75,6	21 900	58 500
30,0	69,4	74,8	14 500	49 300
32,0	67,8	74,0	8 000	41 400
34,0	66,2	73,1		34 700
36,0	64,6	72,2		28 700
38,0	62,9	71,1		23 400
40,0	61,2	70,0		18 000
42,0	59,5	68,9		13 000
44,0	57,8	67,6		8 500

84,0 m				
m	°	m	10,6 m kg	14,6 m kg
10,4	84,7	85,7	77 200	77 400
12,0	83,6	85,5	77 200	77 400
14,0	82,2	85,3	77 200	77 400
16,0	80,8	84,9	77 200	77 400
18,0	79,4	84,6	77 200	77 400
20,0	78,0	84,1	67 700	76 000
22,0	76,6	83,7	53 100	72 000
24,0	75,2	83,1	40 900	66 700
26,0	73,8	82,5	30 700	61 300
28,0	72,4	81,9	22 200	56 100
30,0	70,9	81,2	14 800	49 500
32,0	69,5	80,5	8 300	41 800
34,0	68,0	79,7		35 000
36,0	66,5	78,8		29 000
38,0	65,0	77,9		23 600
40,0	63,5	76,9		18 100
42,0	61,9	75,8		13 100
44,0	60,4	74,7		8 500

MLC300 VPC-MAX S-2

ASME B30.5

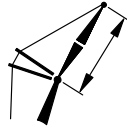
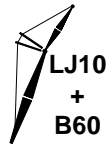

96,0 m



169°

42,0 m				
m	°	m	kg	kg
6,7	84,4	43,9	227 200	227 200
7,0	84,0	43,8	226 500	226 500
8,0	82,6	43,7	224 300	224 300
9,0	81,2	43,5	222 200	222 200
10,0	79,8	43,3	215 400	220 200
12,0	77,0	42,9	159 700	216 400
14,0	74,2	42,3	118 300	196 600
16,0	71,3	41,6	88 200	155 400
18,0	68,4	40,8	65 100	123 200
20,0	65,4	39,9	47 100	99 000
22,0	62,3	38,9	32 800	80 400
24,0	59,1	37,7	20 900	65 200
26,0	55,8	36,3	11 000	52 600
28,0	52,4	34,8		42 300
30,0	48,8	33,1		33 500
32,0	45,0	31,1		25 900
34,0	40,9	28,8		19 300
36,0	36,3	26,2		12 700
38,0	31,2	23,0		6 600

48,0 m				
m	°	m	kg	kg
7,3	84,4	49,8	206 900	206 900
8,0	83,5	49,8	205 900	205 900
9,0	82,3	49,6	204 500	204 500
10,0	81,1	49,4	203 100	203 100
12,0	78,7	49,0	164 500	200 600
14,0	76,2	48,5	122 900	194 000
16,0	73,7	48,0	92 800	159 700
18,0	71,2	47,3	69 600	127 300
20,0	68,7	46,5	51 600	103 000
22,0	66,1	45,6	37 200	84 200
24,0	63,4	44,6	25 300	68 900
26,0	60,6	43,5	15 400	56 300
28,0	57,8	42,2		45 900
30,0	54,9	40,8		37 100
32,0	51,9	39,3		29 400
34,0	48,7	37,6		22 800
36,0	45,4	35,6		16 500
38,0	41,9	33,4		10 400

MLC300 VPC-MAX S-2

ASME B30.5

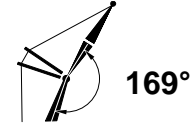
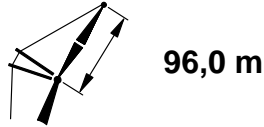
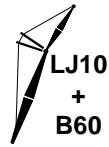

54,0 m				
m	°	m	10,6 m kg	14,6 m kg
7,3	85,0	55,9	186 200	186 200
8,0	84,3	55,8	185 600	185 600
9,0	83,2	55,7	184 700	184 700
10,0	82,1	55,5	183 800	183 800
12,0	80,0	55,2	168 500	182 200
14,0	77,8	54,7	126 900	180 300
16,0	75,6	54,2	96 700	163 200
18,0	73,4	53,6	73 500	130 800
20,0	71,1	52,9	55 400	106 400
22,0	68,9	52,2	41 100	87 500
24,0	66,6	51,3	29 200	72 200
26,0	64,2	50,3	19 200	59 500
28,0	61,8	49,3	10 800	49 100
30,0	59,3	48,1		40 200
32,0	56,8	46,8		32 400
34,0	54,2	45,4		25 800
36,0	51,5	43,8		19 800
38,0	48,7	42,0		13 800
40,0	45,7	40,1		8 300

60,0 m				
m	°	m	10,6 m kg	14,6 m kg
7,9	84,9	61,8	165 000	165 000
8,0	84,8	61,9	164 900	164 900
9,0	83,9	61,7	164 500	164 500
10,0	82,9	61,6	164 100	164 100
12,0	81,0	61,3	163 300	163 300
14,0	79,0	60,9	129 300	162 300
16,0	77,1	60,4	99 100	155 700
18,0	75,1	59,9	75 900	133 000
20,0	73,1	59,3	57 800	108 500
22,0	71,1	58,6	43 400	89 600
24,0	69,0	57,8	31 400	74 200
26,0	67,0	57,0	21 400	61 500
28,0	64,9	56,1	13 000	51 000
30,0	62,7	55,0		42 000
32,0	60,5	53,9		34 300
34,0	58,3	52,7		27 700
36,0	56,0	51,3		21 700
38,0	53,6	49,9		15 700
40,0	51,2	48,3		10 200

MLC300 VPC-MAX S-2

ASME B30.5

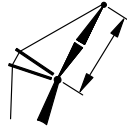
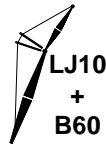

96,0 m



169°

66,0 m				
			10,6 m	14,6 m
m	°	m	kg	kg
8,5	84,8	67,8	144 600	144 600
9,0	84,4	67,8	144 600	144 600
10,0	83,6	67,6	144 400	144 400
12,0	81,8	67,3	143 100	143 100
14,0	80,0	67,0	131 700	136 800
16,0	78,3	66,6	101 500	130 200
18,0	76,5	66,1	78 200	123 700
20,0	74,7	65,5	60 100	110 600
22,0	72,9	64,9	45 700	91 600
24,0	71,0	64,2	33 700	76 200
26,0	69,2	63,5	23 700	63 400
28,0	67,3	62,6	15 300	52 900
30,0	65,4	61,7	8 000	44 000
32,0	63,4	60,7		36 200
34,0	61,5	59,6		29 500
36,0	59,4	58,5		23 600
38,0	57,4	57,2		17 700
40,0	55,3	55,8		12 200
42,0	53,1	54,3		7 200



72,0 m				
			10,6 m	14,6 m
m	°	m	kg	kg
9,1	84,8	73,8	122 800	122 800
10,0	84,1	73,7	122 800	122 800
12,0	82,5	73,4	118 700	118 700
14,0	80,9	73,1	113 500	113 500
16,0	79,3	72,7	101 400	108 000
18,0	77,6	72,3	79 400	102 500
20,0	76,0	71,8	61 300	97 000
22,0	74,3	71,2	46 800	89 900
24,0	72,7	70,6	34 800	77 300
26,0	71,0	69,9	24 800	64 500
28,0	69,3	69,1	16 400	54 000
30,0	67,6	68,3	9 100	44 900
32,0	65,8	67,4		37 100
34,0	64,1	66,4		30 500
36,0	62,3	65,4		24 500
38,0	60,4	64,3		18 500
40,0	58,6	63,0		13 000
42,0	56,7	61,7		8 100

MLC300 VPC-MAX S-2

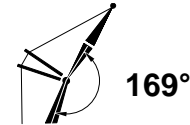
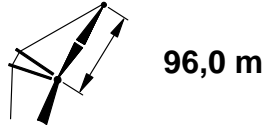
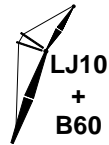
ASME B30.5

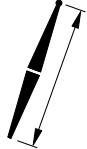
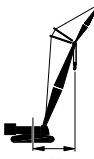
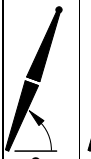
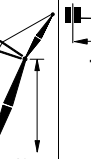
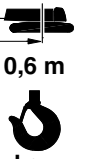
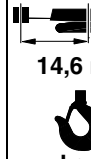

 78,0 m				
 m	 °	 m	 10,6 m kg	 14,6 m kg
9,8	84,7	79,8	93 500	93 500
10,0	84,6	79,7	93 500	93 500
12,0	83,1	79,5	93 500	93 500
14,0	81,6	79,2	91 900	91 900
16,0	80,1	78,8	88 100	88 100
18,0	78,6	78,4	79 600	86 100
20,0	77,1	78,0	62 700	84 300
22,0	75,6	77,5	48 200	80 200
24,0	74,0	76,9	36 200	73 600
26,0	72,5	76,2	26 100	65 700
28,0	71,0	75,6	17 700	55 100
30,0	69,4	74,8	10 400	46 100
32,0	67,8	74,0		38 300
34,0	66,2	73,1		31 600
36,0	64,6	72,2		25 600
38,0	62,9	71,1		19 600
40,0	61,2	70,0		14 100
42,0	59,5	68,9		9 100

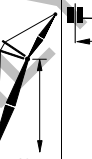
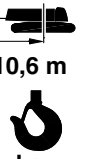
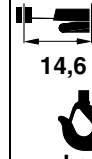
 84,0 m				
 m	 °	 m	 10,6 m kg	 14,6 m kg
10,4	84,7	85,7	72 900	73 100
12,0	83,6	85,5	72 900	73 100
14,0	82,2	85,3	72 900	73 100
16,0	80,8	84,9	72 900	73 100
18,0	79,4	84,6	72 800	72 800
20,0	78,0	84,1	63 200	71 100
22,0	76,6	83,7	48 700	65 700
24,0	75,2	83,1	36 700	60 400
26,0	73,8	82,5	26 600	55 100
28,0	72,4	81,9	18 100	49 900
30,0	70,9	81,2	10 800	44 900
32,0	69,5	80,5		38 700
34,0	68,0	79,7		32 000
36,0	66,5	78,8		25 800
38,0	65,0	77,9		19 700
40,0	63,5	76,9		14 300
42,0	61,9	75,8		9 300