

# Liftcrane Jib Capacities

Jib No. 148 on  
 Boom No. B60:500  
 with Mast No. M10:503 or Mast No. M11:503  
 175 100 kg VPC (Variable Position Counterweight)  
 Crawler Machine on a Barge  
 0 Degree thru 2 Degree Static Machine List  
 No Travel - 360 Degree Rating

## MLC300 VPC-MAX SERIES 2



**LIFTING CAPACITIES:** Chart supplements Boom Capacity chart **No. 9439-AM**. Lifting capacities are for a crawler machine when operating on a barge. Machine shall be positively secured to prevent shifting. Lifting capacities for various boom lengths, jib lengths, and jib operating radii are for freely suspended loads and may be based on percent of static tipping or strength of structural components. Capacities must be reduced by applicable deducts.

Weight of all load blocks, hooks, weight ball, slings, hoist lines, etc., beneath boom and jib point sheaves is considered part of load. Boom and jib are not to be lowered beyond radii where combined weights are greater than rated capacity. Where no capacity is shown, operation is not intended or approved.

**BOOM BACKWARD STABILITY:** Capacities indicated by (b) require 1 090 kg minimum weight suspended beneath jib point, (c) require 4 530 kg minimum weight, and (d) require 9 070 kg minimum weight. **Caution: Do not operate in areas indicated by (b), (c), or (d) without required minimum weight.** *Boom and jib may not lower and boom hoist wire rope may go slack causing wire rope damage or failure.*

**OPERATING CONDITIONS:** Machine to operate on a firm and uniformly supporting surface with machine list not to exceed degrees noted. Refer to Boom Rigging **No. 81023382**, Jib Rigging **No. 84049566**, Mast Rigging **No. 81025690** or **No. 84045340**, Wire Rope Specification chart **No. 9366-A**, Counterweight Arrangements chart **No. 9345-A**, and Wind Conditions chart **No. 9480-A**. Crane operator judgment must be used to allow for dynamic load effects of swinging, hoisting or lowering, wind conditions, as well as adverse operating conditions and physical machine depreciation. Refer to the Operator Manual for operating guidelines.



**OPERATING RADIUS:** Operating radius is horizontal distance from axis of rotation at barge deck to center of vertical hoist line or load block.



**BOOM ANGLE:** Boom angle in degrees (°) is angle between horizontal and centerline of boom butt and inserts, and is an indication of operating radius. In all cases, operating radius shall govern capacity.



**JIB POINT ELEVATION:** Jib point elevation is vertical distance from barge deck to centerline of jib point shaft.

**MACHINE EQUIPMENT:** Machine equipped with VPC-MAX, 9 700 mm crawlers, 1 219 mm or 1 524 mm treads, 9 144 mm live mast, 30 0 m mast 10 part boom hoist reeving, boom support straps, and 175 100 kg VPC.

**Warning:** Luffing jib backstay straps must be removed before use of this chart. *Crane tipping or structural damage can occur.*

# MLC300 VPC-MAX S-2



Refer to Table 1 for raising ability with the maximum weight of all load blocks, hooks, weight ball, slings, and hoist lines beneath boom and jib point sheaves. For block weights shown with #, load blocks, hooks, weight ball, and slings must remain on barge deck until combined weights are within rated capacity of chart. Raising is not permitted in shaded areas of table.

Select counterweight position from Table 1 that will allow raising and lowering of boom and jib length. Counterweight position selection may be changed with jib on barge deck or while jib is within operating range of capacity chart.

Combined weight beneath boom and jib point sheaves must not exceed block weight shown. Total weight beneath jib point must not exceed 2 800 kg.

**Table 1a**

Over End or Side of Crawlers												
Boom Length (m)	12,0 m Jib Length						18,0 m Jib Length					
	Counterweight Position						Counterweight Position					
	10,6 m			14,6 m			10,6 m			14,6 m		
	Machine List						Machine List					
	0°	1°	2°	0°	1°	2°	0°	1°	2°	0°	1°	2°
	Block Weight (kg)						Block Weight (kg)					
42,0	10 300	10 300	10 300	10 300	10 300	10 300	10 300	10 300	10 300	10 300	10 300	10 300
48,0	10 300	10 300	10 300	10 300	10 300	10 300	10 300	10 300	10 300	10 300	10 300	10 300
54,0	10 300	10 300	10 300	10 300	10 300	10 300	10 300	10 300	10 300	10 300	10 300	10 300
60,0	10 300	10 300	10 300	10 300	10 300	10 300	10 300	10 300	10 300	10 300	10 300	10 300
66,0	10 300	10 300	10 300	10 300	10 300	10 300	10 300	10 300	10 300	10 300	10 300	10 300
72,0	10 300	10 300	10 300	10 300	10 300	10 300	10 300	10 300	10 300	10 300	10 300	10 300
78,0	10 300	10 300	10 300	10 300	10 300	10 300	10 300	10 300	10 300	10 300	10 300	10 300
84,0	10 300	10 300	10 300	10 300	10 300	10 300	7 100	7 100	7 100	10 300	10 300	10 300
90,0	7 100	7 100	7 100	10 300	10 300	10 300	7 100	3 700	3 700	10 300	10 300	10 300
96,0	3 700	3 700	3 700	3 700	3 700	3 700	3 700	3 700	#	3 700	3 700	3 700
102,0	#	#		#	#		#	#		#	#	
108,0				#	#		Raising Not Permitted			#	#	

# MLC300 VPC-MAX S-2



Table 1b

Over End or Side of Crawlers												
Boom Length (m)	24,0 m Jib Length						30,0 m Jib Length					
	Counterweight Position						Counterweight Position					
	10,6 m			14,6 m			10,6 m			14,6 m		
	Machine List						Machine List					
	0°	1°	2°	0°	1°	2°	0°	1°	2°	0°	1°	2°
	Block Weight (kg)						Block Weight (kg)					
42,0	10 300	10 300	10 300	10 300	10 300	10 300	10 300	10 300	10 300	10 300	10 300	10 300
48,0	10 300	10 300	10 300	10 300	10 300	10 300	10 300	10 300	10 300	10 300	10 300	10 300
54,0	10 300	10 300	10 300	10 300	10 300	10 300	10 300	10 300	10 300	10 300	10 300	10 300
60,0	10 300	10 300	10 300	10 300	10 300	10 300	10 300	10 300	10 300	10 300	10 300	10 300
66,0	10 300	10 300	10 300	10 300	10 300	10 300	10 300	10 300	10 300	10 300	10 300	10 300
72,0	10 300	10 300	10 300	10 300	10 300	10 300	10 300	10 300	10 300	10 300	10 300	10 300
78,0	10 300	10 300	10 300	10 300	10 300	10 300	10 300	10 300	10 300	10 300	10 300	10 300
84,0	7 100	7 100	7 100	10 300	10 300	10 300	7 100	7 100	7 100	10 300	10 300	10 300
90,0	3 700	3 700	3 700	10 300	10 300	10 300	3 700	3 700	3 700	10 300	10 300	10 300
96,0	#	#	#	3 700	3 700	3 700	#	#	#	3 700	3 700	3 700
102,0	#	#	#	#	#	#	#	#	#	#	#	#
108,0	#	#	#	#	#	#	Raising Not Permitted			#	#	#

Table 1c

Over End or Side of Crawlers												
Boom Length (m)	36,0 m Jib Length						42,0 m Jib Length					
	Counterweight Position						Counterweight Position					
	10,6 m			14,6 m			10,6 m			14,6 m		
	Machine List						Machine List					
	0°	1°	2°	0°	1°	2°	0°	1°	2°	0°	1°	2°
	Block Weight (kg)						Block Weight (kg)					
42,0	10 300	10 300	10 300	10 300	10 300	10 300	10 300	10 300	10 300	10 300	10 300	10 300
48,0	10 300	10 300	10 300	10 300	10 300	10 300	10 300	10 300	10 300	10 300	10 300	10 300
54,0	10 300	10 300	10 300	10 300	10 300	10 300	10 300	10 300	10 300	10 300	10 300	10 300
60,0	10 300	10 300	10 300	10 300	10 300	10 300	10 300	10 300	10 300	10 300	10 300	10 300
66,0	10 300	10 300	10 300	10 300	10 300	10 300	10 300	10 300	10 300	10 300	10 300	10 300
72,0	10 300	10 300	10 300	10 300	10 300	10 300	10 300	10 300	10 300	10 300	10 300	10 300
78,0	10 300	10 300	10 300	10 300	10 300	10 300	7 100	7 100	7 100	10 300	10 300	10 300
84,0	3 700	3 700	3 700	10 300	10 300	10 300	3 700	3 700	3 700	10 300	7 100	7 100
90,0	3 700	3 700	3 700	10 300	7 100	7 100	#	#	#	10 300	3 700	3 700
96,0	#	#	#	3 700	3 700	3 700	#	#	#	3 700	#	#
102,0	#	#	#	#	#	#	#	#	#	#	#	#
108,0	#	#	#	#	#	#	Raising Not Permitted			#	#	#

Explanation of Symbols



Jib No. 148  
+  
Boom No. B60:500



VPC (Variable Position Counterweight)



360 Degree Rating



Boom Length

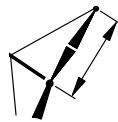

Jib Length

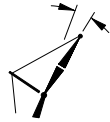

Jib Offset Angle

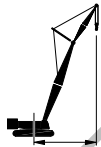

Operating Radius  
(see page 1)



Boom Angle  
(see page 1)



Jib Point Elevation  
(see page 1)

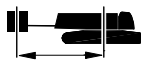

Counterweight Position  
from Axis of Rotation

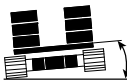

Machine List



Lifting Capacities  
(see page 1)

# MLC300 VPC-MAX S-2

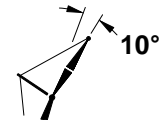
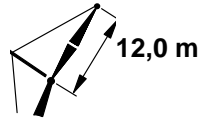
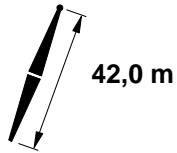

m	°	m	10,6 m			14,6 m			m			
			0°			1°				2°		
			kg	kg	kg	kg	kg	kg		kg	kg	kg
11,6	82,3	55,5	65 000c	61 600d		65 000c	61 600d		11,6			
12,0	81,8	55,4	65 000c	61 500d		65 000c	61 500d		12,0			
14,0	79,7	55,0	65 000b	61 000c		65 000b	61 000c		14,0			
16,0	77,5	54,5	65 000	60 600c	55 800d	65 000	60 600c	55 800d	16,0			
18,0	75,3	53,9	65 000	60 200	55 500c	65 000	60 200	55 500c	18,0			
20,0	73,1	53,2	64 700	59 900	55 200b	64 700	59 900	55 200b	20,0			
22,0	70,8	52,4	61 700	58 800		61 700	58 800		22,0			
24,0	68,5	51,6	57 800	57 100		57 800	57 100		24,0			
26,0	66,1	50,6	54 400	54 100		54 400	54 100		26,0			
28,0	63,8	49,6	51 400	51 200		51 400	51 200		28,0			
30,0	61,3	48,4	48 700	48 500		48 700	48 500		30,0			
32,0	58,8	47,1	46 300	46 100		46 300	46 100		32,0			
34,0	56,2	45,7	44 200	44 000		44 200	44 000		34,0			
36,0	53,5	44,1	42 200	42 100		42 200	42 100		36,0			
38,0	50,7	42,4	40 400	40 300		40 400	40 300		38,0			
40,0	47,8	40,5	38 900	38 800		38 900	38 800		40,0			
42,0	44,7	38,3	37 400	37 300		37 400	37 300		42,0			
44,0	41,5	36,0	36 100	36 000		36 100	36 000		44,0			
46,0	37,9	33,3	34 900	34 800		34 900	34 800		46,0			
48,0	34,0	30,2	33 800	33 800		33 800	33 800		48,0			
50,0	29,7	26,6	32 900	32 800		32 900	32 800		50,0			
52,0	24,5	22,1	32 100	32 100		32 100	32 100		52,0			

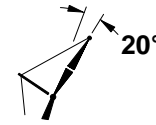
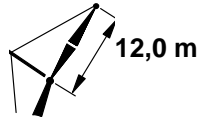
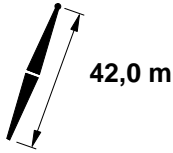
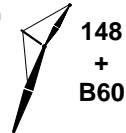

# MLC300 VPC-MAX S-2

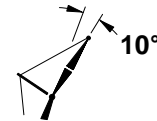
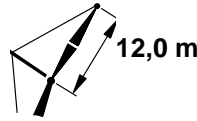
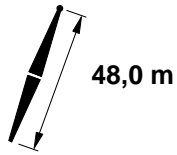

m	°	m	10,6 m			14,6 m			m					
			0°			1°				2°				
			kg	kg	kg	kg	kg	kg		kg	kg	kg		
11,6														
12,0														
14,0	81,6	54,5	60 400c	58 900c		60 400c	58 900c							
16,0	79,4	54,0	56 600b	56 500c	53 500d	56 600b	56 500c	53 500d						
18,0	77,2	53,4	53 200	53 100b	52 400c	53 200	53 100b	52 400c						
20,0	74,9	52,7	50 200	50 200	49 900b	50 200	50 200	49 900b						
22,0	72,7	51,9	47 600	47 600	47 400	47 600	47 600	47 400						
24,0	70,3	51,1	45 300	45 200	45 100	45 300	45 200	45 100						
26,0	68,0	50,1	43 200	43 200	43 000	43 200	43 200	43 000						
28,0	65,6	49,0	41 300	41 300	41 200	41 300	41 300	41 200						
30,0	63,1	47,8	39 600	39 600	39 500	39 600	39 600	39 500						
32,0	60,5	46,5	38 100	38 000	38 000	38 100	38 000	38 000						
34,0	57,9	45,1	36 700	36 600	36 600	36 700	36 600	36 600						
36,0	55,2	43,5	35 400	35 400	35 300	35 400	35 400	35 300						
38,0	52,4	41,7	34 300	34 200	34 200	34 300	34 200	34 200						
40,0	49,4	39,8	33 200	33 200	33 200	33 200	33 200	33 200						
42,0	46,3	37,6	32 300	32 300	32 200	32 300	32 300	32 200						
44,0	42,9	35,2	31 400	31 400	31 400	31 400	31 400	31 400						
46,0	39,3	32,5	30 700	30 700	30 600	30 700	30 700	30 600						
48,0	35,3	29,3	30 000	30 000	30 000	30 000	30 000	30 000						
50,0	30,8	25,6	29 500			29 500								
52,0														

# MLC300 VPC-MAX S-2

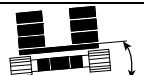
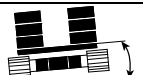

			 10,6 m			 14,6 m					
			 0°    1°    2°			 0°    1°    2°					
			kg	kg	kg	kg	kg	kg			
m	°	m	kg	kg	kg	kg	kg	kg	m		
9,8	84,8	61,9	65 000d			65 000d			9,8		
10,0	84,6	61,8	65 000d			65 000d			10,0		
11,0	83,6	61,7	65 000c	61 500d		65 000c	61 500d		11,0		
12,0	82,7	61,5	65 000c	61 200c		65 000c	61 200c		12,0		
14,0	80,7	61,1	65 000	60 800c	55 500d	65 000	60 800c	55 500d	14,0		
16,0	78,8	60,7	65 000	60 400b	55 200c	65 000	60 400b	55 200c	16,0		
18,0	76,8	60,2	65 000	60 000	54 900	65 000	60 000	54 900	18,0		
20,0	74,8	59,5	65 000	59 700	54 700	65 000	59 700	54 700	20,0		
22,0	72,8	58,9	64 400	59 400	54 500	64 400	59 400	54 500	22,0		
24,0	70,8	58,1	61 500	58 500	53 900	61 500	58 500	53 900	24,0		
26,0	68,7	57,3	58 000	57 100	52 900	58 000	57 100	52 900	26,0		
28,0	66,6	56,3	54 900	54 600	51 900	54 900	54 600	51 900	28,0		
30,0	64,5	55,3	52 200	51 900	50 900	52 200	51 900	50 900	30,0		
32,0	62,3	54,2	49 700	49 400	49 100	49 700	49 400	49 100	32,0		
34,0	60,1	52,9	47 400	47 200	46 900	47 400	47 200	46 900	34,0		
36,0	57,8	51,6	45 400	45 200	44 900	45 400	45 200	44 900	36,0		
38,0	55,4	50,2	43 500	43 400	43 100	43 500	43 400	43 100	38,0		
40,0	53,0	48,6	41 800	41 700	41 400	41 800	41 700	41 400	40,0		
42,0	50,5	46,8	40 300	40 200	39 900	40 300	40 200	39 900	42,0		
44,0	47,8	44,9	38 900	38 800	38 600	38 900	38 800	38 600	44,0		
46,0	45,1	42,8	37 500	37 400	37 200	37 500	37 400	37 200	46,0		
48,0	42,2	40,5	36 400	36 300	36 100	36 400	36 300	36 100	48,0		
50,0	39,1	38,0	35 300	35 200	35 000	35 300	35 200	35 000	50,0		
52,0	35,8	35,1	34 300	34 200	34 000	34 300	34 200	34 000	52,0		
54,0	32,1	31,8	33 400	33 300	33 200	33 400	33 300	33 200	54,0		
56,0	28,0	28,0	32 600	32 500	32 100	32 600	32 500	32 400	56,0		
58,0	23,1	23,2	31 900			31 900			58,0		

# MLC300 VPC-MAX S-2

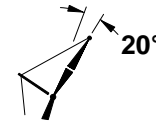
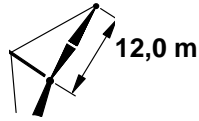
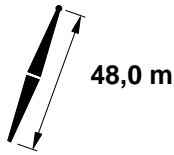





m	°	m	10,6 m			14,6 m			m
			0°	1°	2°	0°	1°	2°	
			kg	kg	kg	kg	kg	kg	
9,8									9,8
10,0									10,0
11,0									11,0
12,0	84,4	61,1	65 000c			65 000c			12,0
14,0	82,5	60,7	61 900c			61 900c	58 700c	53 800d	14,0
16,0	80,5	60,2	58 300	57 800c	53 500c	58 300	57 800c	53 500c	16,0
18,0	78,5	59,7	55 000	54 900	52 700c	55 000	54 900	52 700c	18,0
20,0	76,5	59,1	52 100	52 100	51 700	52 100	52 100	51 700	20,0
22,0	74,5	58,4	49 600	49 500	49 400	49 600	49 500	49 400	22,0
24,0	72,4	57,6	47 300	47 200	47 100	47 300	47 200	47 100	24,0
26,0	70,4	56,7	45 200	45 200	45 100	45 200	45 200	45 100	26,0
28,0	68,2	55,8	43 400	43 300	43 200	43 400	43 300	43 200	28,0
30,0	66,1	54,8	41 600	41 600	41 500	41 600	41 600	41 500	30,0
32,0	63,9	53,6	40 100	40 100	40 000	40 100	40 100	40 000	32,0
34,0	61,6	52,4	38 700	38 600	38 600	38 700	38 600	38 600	34,0
36,0	59,3	51,0	37 400	37 300	37 300	37 400	37 300	37 300	36,0
38,0	56,9	49,6	36 200	36 100	36 100	36 200	36 100	36 100	38,0
40,0	54,5	48,0	35 100	35 100	35 000	35 100	35 100	35 000	40,0
42,0	51,9	46,2	34 100	34 100	34 000	34 100	34 100	34 000	42,0
44,0	49,3	44,3	33 200	33 200	33 100	33 200	33 200	33 100	44,0
46,0	46,5	42,2	32 300	32 300	32 200	32 300	32 300	32 200	46,0
48,0	43,5	39,8	31 500	31 600	31 500	31 500	31 600	31 500	48,0
50,0	40,4	37,2	30 900	30 900	30 800	30 900	30 900	30 800	50,0
52,0	36,9	34,2	30 300	30 200	30 200	30 300	30 200	30 200	52,0
54,0	33,2	30,9	29 800	29 700	29 700	29 800	29 700	29 700	54,0
56,0	28,9	26,8	29 300			29 300			56,0
58,0									58,0

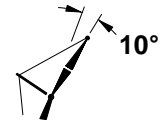
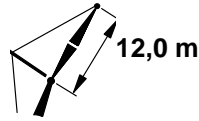
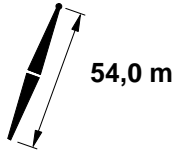

# MLC300 VPC-MAX S-2



			 10,6 m			 14,6 m					
			 0°			 1°			 2°		
			kg	kg	kg	kg	kg	kg			
10,4	84,8	67,8	65 000c			65 000c			10,4		
11,0	84,2	67,8	65 000c			65 000c			11,0		
12,0	83,3	67,6	65 000b	60 800c		65 000b	60 800c		12,0		
14,0	81,6	67,3	65 000	60 400c	55 000d	65 000	60 400c	55 000d	14,0		
16,0	79,8	66,8	65 000	60 000b	54 800c	65 000	60 000b	54 800c	16,0		
18,0	78,0	66,4	65 000	59 700	54 500	65 000	59 700	54 500	18,0		
20,0	76,2	65,8	65 000	59 400	54 400	65 000	59 400	54 400	20,0		
22,0	74,4	65,2	65 000	59 200	54 200	65 000	59 200	54 200	22,0		
24,0	72,6	64,5	64 300	59 000	54 100	64 300	59 000	54 100	24,0		
26,0	70,7	63,8	61 300	58 100	53 500	61 300	58 100	53 500	26,0		
28,0	68,9	62,9	58 200	57 000	52 600	58 200	57 000	52 600	28,0		
30,0	67,0	62,0	55 300	55 000	51 800	55 300	55 000	51 800	30,0		
32,0	65,0	61,0	52 800	52 500	50 900	52 800	52 500	50 900	32,0		
34,0	63,1	59,9	50 500	50 200	49 800	50 500	50 200	49 800	34,0		
36,0	61,1	58,8	48 300	48 100	47 800	48 300	48 100	47 800	36,0		
38,0	59,0	57,5	46 400	46 200	45 900	46 400	46 200	45 900	38,0		
40,0	56,9	56,1	44 700	44 500	44 200	44 700	44 500	44 200	40,0		
42,0	54,8	54,6	43 000	42 900	42 600	43 000	42 900	42 600	42,0		
44,0	52,6	53,0	41 500	41 400	41 200	41 500	41 400	41 200	44,0		
46,0	50,3	51,3	40 100	40 000	39 800	40 100	40 000	39 800	46,0		
48,0	47,9	49,4	38 900	38 700	38 600	38 900	38 700	38 600	48,0		
50,0	45,4	47,4	37 700	37 600	37 200	37 700	37 600	37 400	50,0		
52,0	42,8	45,1	36 600	36 400	35 700	36 600	36 500	36 300	52,0		
54,0	40,1	42,6	35 500	34 700	33 800	35 600	35 500	35 300	54,0		
56,0	37,1	39,9	33 900	33 000	32 100	34 700	34 600	34 400	56,0		
58,0	34,0	36,8	32 100	31 200	30 400	33 800	33 700	33 600	58,0		
60,0	30,5	33,4	30 400	29 600	28 900	33 000	33 000	32 800	60,0		
62,0	26,6	29,3	28 800	28 100	27 500	32 400	32 300	32 200	62,0		
64,0	21,9	24,3	27 200	26 700	26 200	31 800	31 700	31 600	64,0		

# MLC300 VPC-MAX S-2

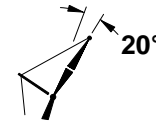
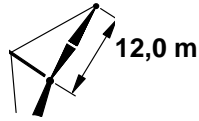
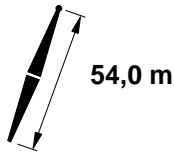
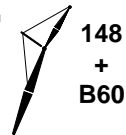

m	°	m	10,6 m			14,6 m			m			
			0°			1°				2°		
			kg	kg	kg	kg	kg	kg		kg	kg	
10,4										10,4		
11,0										11,0		
12,0										12,0		
14,0	83,2	66,8	63 100b	58 300c		63 100b	58 300c			14,0		
16,0	81,4	66,4	59 700	58 100c	52 500c	59 700	58 100c	52 500c		16,0		
18,0	79,6	65,9	56 600	56 400	52 500b	56 600	56 400	52 500b		18,0		
20,0	77,8	65,3	53 800	53 700	52 100	53 800	53 700	52 100		20,0		
22,0	76,0	64,7	51 300	51 300	51 000	51 300	51 300	51 000		22,0		
24,0	74,1	64,0	49 100	49 000	48 900	49 100	49 000	48 900		24,0		
26,0	72,3	63,2	47 000	47 000	46 900	47 000	47 000	46 900		26,0		
28,0	70,4	62,4	45 200	45 200	45 000	45 200	45 200	45 000		28,0		
30,0	68,5	61,5	43 500	43 400	43 300	43 500	43 400	43 300		30,0		
32,0	66,5	60,5	41 900	41 900	41 800	41 900	41 900	41 800		32,0		
34,0	64,5	59,4	40 500	40 500	40 400	40 500	40 500	40 400		34,0		
36,0	62,5	58,2	39 200	39 100	39 100	39 200	39 100	39 100		36,0		
38,0	60,4	56,9	37 900	37 900	37 800	37 900	37 900	37 800		38,0		
40,0	58,3	55,5	36 800	36 800	36 700	36 800	36 800	36 700		40,0		
42,0	56,1	54,0	35 800	35 800	35 700	35 800	35 800	35 700		42,0		
44,0	53,9	52,4	34 800	34 800	34 800	34 800	34 800	34 800		44,0		
46,0	51,6	50,7	33 900	33 900	33 900	33 900	33 900	33 900		46,0		
48,0	49,2	48,7	33 100	33 100	33 000	33 100	33 100	33 000		48,0		
50,0	46,6	46,7	32 300	32 300	32 300	32 300	32 300	32 300		50,0		
52,0	44,0	44,4	31 700	31 600	31 600	31 700	31 600	31 600		52,0		
54,0	41,2	41,9	31 000	31 000	31 000	31 000	31 000	31 000		54,0		
56,0	38,2	39,1	30 500	30 500	30 400	30 500	30 500	30 400		56,0		
58,0	35,0	35,9	30 000	29 900	29 900	30 000	29 900	29 900		58,0		
60,0	31,4	32,3	29 500	29 300	28 800	29 500	29 600	29 500		60,0		
62,0										62,0		
64,0										64,0		

# MLC300 VPC-MAX S-2

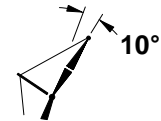
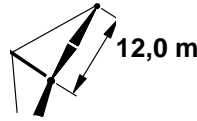
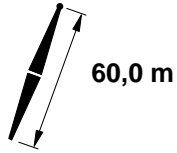

m	°	m	10,6 m			14,6 m			m			
			0°			1°				2°		
			kg	kg	kg	kg	kg	kg		kg	kg	
11,0	84,7	73,8	65 000c			65 000c			11,0			
12,0	83,9	73,7	65 000			65 000			12,0			
14,0	82,3	73,4	65 000	59 800b	54 400c	65 000	59 800b	54 400c	14,0			
16,0	80,7	73,0	65 000	59 500	54 200c	65 000	59 500	54 200c	16,0			
18,0	79,0	72,5	65 000	59 300	54 000	65 000	59 300	54 000	18,0			
20,0	77,4	72,0	65 000	59 000	53 900	65 000	59 000	53 900	20,0			
22,0	75,8	71,5	65 000	58 800	53 700	65 000	58 800	53 700	22,0			
24,0	74,1	70,9	64 800	58 600	53 600	64 800	58 600	53 600	24,0			
26,0	72,4	70,2	64 300	58 400	53 500	64 300	58 400	53 500	26,0			
28,0	70,7	69,4	61 200	57 700	53 000	61 200	57 700	53 000	28,0			
30,0	69,0	68,6	58 300	56 700	52 300	58 300	56 700	52 300	30,0			
32,0	67,3	67,7	55 700	55 400	51 500	55 700	55 400	51 500	32,0			
34,0	65,5	66,7	53 300	53 000	50 800	53 300	53 000	50 800	34,0			
36,0	63,7	65,7	51 100	50 900	50 100	51 100	50 900	50 100	36,0			
38,0	61,9	64,6	49 100	48 900	48 600	49 100	48 900	48 600	38,0			
40,0	60,1	63,4	47 300	47 100	46 800	47 300	47 100	46 800	40,0			
42,0	58,2	62,0	45 600	45 400	45 100	45 600	45 400	45 100	42,0			
44,0	56,2	60,6	44 100	43 900	43 300	44 100	43 900	43 600	44,0			
46,0	54,2	59,1	42 600	42 300	41 400	42 600	42 400	42 200	46,0			
48,0	52,2	57,5	41 300	40 300	39 000	41 300	41 100	40 900	48,0			
50,0	50,1	55,8	39 600	38 200	36 800	40 000	39 900	39 700	50,0			
52,0	47,9	53,9	37 300	36 000	34 700	38 900	38 700	38 500	52,0			
54,0	45,7	51,9	35 200	34 000	32 900	37 800	37 700	37 500	54,0			
56,0	43,3	49,7	33 200	32 200	31 100	36 800	36 700	36 500	56,0			
58,0	40,8	47,3	31 400	30 400	29 500	35 800	35 700	35 600	58,0			
60,0	38,2	44,6	29 700	28 900	28 000	35 000	34 900	34 700	60,0			
62,0	35,4	41,7	28 100	27 400	26 600	34 200	34 100	33 900	62,0			
64,0	32,4	38,5	26 600	25 900	25 200	33 400	33 300	33 200	64,0			
66,0	29,1	34,8	25 300	24 600	24 000	32 800	32 700	32 500	66,0			
68,0	25,3	30,5	23 900	23 400	22 800	32 200	31 900	31 600	68,0			
70,0	20,9	25,3	22 500	22 200	21 700	31 400	30 900	30 400	70,0			



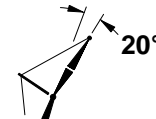
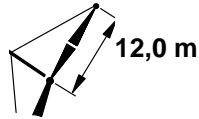
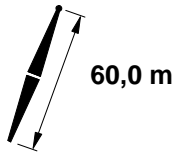

# MLC300 VPC-MAX S-2

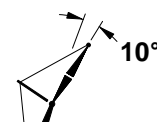
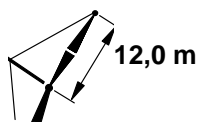
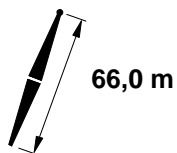

m	°	m	10,6 m			14,6 m			m
			0°			0°			
			kg	kg	kg	kg	kg	kg	
11,0									11,0
12,0									12,0
14,0	83,8	72,9	63 500	57 700c		63 500	57 700c		14,0
16,0	82,1	72,5	60 900	57 600b	51 100c	60 900	57 600b	51 100c	16,0
18,0	80,5	72,0	57 900	57 300	51 100b	57 900	57 300	51 100b	18,0
20,0	78,8	71,5	55 300	55 200	51 100	55 300	55 200	51 100	20,0
22,0	77,2	71,0	52 800	52 800	51 000	52 800	52 800	51 000	22,0
24,0	75,5	70,3	50 600	50 600	50 300	50 600	50 600	50 300	24,0
26,0	73,8	69,7	48 600	48 600	48 500	48 600	48 600	48 500	26,0
28,0	72,1	68,9	46 800	46 800	46 600	46 800	46 800	46 600	28,0
30,0	70,4	68,1	45 100	45 100	45 000	45 100	45 100	45 000	30,0
32,0	68,6	67,2	43 600	43 500	43 400	43 600	43 500	43 400	32,0
34,0	66,9	66,2	42 200	42 100	42 000	42 200	42 100	42 000	34,0
36,0	65,1	65,1	40 800	40 800	40 700	40 800	40 800	40 700	36,0
38,0	63,2	64,0	39 600	39 500	39 500	39 600	39 500	39 500	38,0
40,0	61,3	62,8	38 400	38 400	38 300	38 400	38 400	38 300	40,0
42,0	59,4	61,5	37 400	37 400	37 300	37 400	37 400	37 300	42,0
44,0	57,5	60,0	36 400	36 400	36 300	36 400	36 400	36 300	44,0
46,0	55,5	58,5	35 500	35 500	35 400	35 500	35 500	35 400	46,0
48,0	53,4	56,9	34 600	34 600	34 500	34 600	34 600	34 500	48,0
50,0	51,3	55,1	33 800	33 800	33 700	33 800	33 800	33 700	50,0
52,0	49,1	53,2	33 100	33 000	33 000	33 100	33 000	33 000	52,0
54,0	46,8	51,2	32 400	32 400	32 300	32 400	32 400	32 300	54,0
56,0	44,4	48,9	31 700	31 600	31 200	31 700	31 700	31 700	56,0
58,0	41,9	46,5	31 100	30 700	29 700	31 100	31 100	31 100	58,0
60,0	39,2	43,8	29 900	29 100	28 200	30 600	30 600	30 600	60,0
62,0	36,4	40,8	28 300	27 500	26 700	30 200	30 200	30 100	62,0
64,0	33,3	37,5	26 800	26 100	25 400	29 700	29 700	29 700	64,0
66,0	29,8	33,7	25 400	24 700	24 100	29 400	29 400	29 400	66,0
68,0									68,0
70,0									70,0

# MLC300 VPC-MAX S-2



			 10,6 m			 14,6 m					
			 0°			 1°			 2°		
			kg	kg	kg	kg	kg	kg			
11,6	84,7	79,8	65 000			65 000			11,6		
12,0	84,4	79,7	65 000			65 000			12,0		
14,0	82,9	79,4	65 000	59 200b		65 000	59 200b		14,0		
16,0	81,4	79,1	65 000	58 900	53 100c	65 000	58 900	53 100c	16,0		
18,0	79,9	78,7	65 000	58 700	53 000	65 000	58 700	53 000	18,0		
20,0	78,4	78,2	64 900	58 500	52 800	64 900	58 500	52 800	20,0		
22,0	76,9	77,7	64 700	58 300	52 700	64 700	58 300	52 700	22,0		
24,0	75,4	77,1	64 500	58 100	52 600	64 500	58 100	52 600	24,0		
26,0	73,8	76,5	64 200	57 900	52 500	64 200	57 900	52 500	26,0		
28,0	72,3	75,8	63 500	57 800	52 400	63 500	57 800	52 400	28,0		
30,0	70,7	75,0	61 000	57 200	52 300	61 000	57 200	52 300	30,0		
32,0	69,1	74,2	58 300	56 300	51 800	58 300	56 300	51 800	32,0		
34,0	67,5	73,4	55 900	55 300	51 200	55 900	55 300	51 200	34,0		
36,0	65,9	72,4	53 800	53 400	50 500	53 800	53 400	50 500	36,0		
38,0	64,3	71,4	51 700	51 400	49 900	51 700	51 400	49 900	38,0		
40,0	62,6	70,3	49 800	49 600	48 900	49 800	49 600	49 100	40,0		
42,0	60,9	69,1	48 100	47 900	46 100	48 100	47 900	47 500	42,0		
44,0	59,2	67,9	46 500	45 400	43 400	46 500	46 300	46 000	44,0		
46,0	57,4	66,5	44 600	42 600	40 800	45 000	44 800	44 500	46,0		
48,0	55,6	65,1	41 900	40 100	38 400	43 600	43 400	43 200	48,0		
50,0	53,8	63,6	39 400	37 800	36 300	42 300	42 100	41 900	50,0		
52,0	51,9	62,0	37 100	35 600	34 200	41 100	40 900	40 700	52,0		
54,0	49,9	60,2	34 900	33 600	32 400	39 900	39 800	39 600	54,0		
56,0	47,9	58,3	33 000	31 800	30 600	38 900	38 700	38 500	56,0		
58,0	45,8	56,3	31 200	30 100	29 000	37 900	37 800	37 500	58,0		
60,0	43,7	54,2	29 500	28 500	27 500	36 900	36 800	36 600	60,0		
62,0	41,4	51,8	27 900	27 000	26 100	36 100	36 000	35 500	62,0		
64,0	39,1	49,3	26 400	25 600	24 700	35 200	35 100	34 100	64,0		
66,0	36,6	46,5	25 000	24 300	23 500	34 300	33 500	32 600	66,0		
68,0	33,9	43,4	23 600	23 000	22 300	32 800	32 000	31 200	68,0		
70,0	31,0	40,0	22 200	21 700	21 200	31 300	30 500	29 800	70,0		
72,0	27,8	36,2	20 900	20 500	20 100	29 800	29 200	28 600	72,0		
74,0	24,2	31,6	19 700	19 300	19 000	28 500	27 900	27 400	74,0		
76,0	19,9	26,1	18 500	18 200	17 900	27 200	26 700	26 200	76,0		

# MLC300 VPC-MAX S-2



148  
+  
B60

175 100 kg

360°

66,0 m





12,0 m

20°

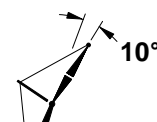
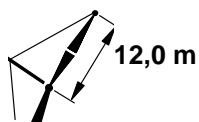
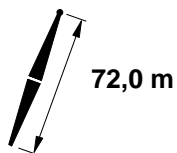
			10,6 m			14,6 m					
			0°			1°			2°		
m	°	m	kg	kg	kg	kg	kg	kg	kg	m	
11,6										11,6	
12,0										12,0	
14,0	84,2	78,9	63 300			63 300				14,0	
16,0	82,7	78,6	61 900	57 000b		61 900	57 000b			16,0	
18,0	81,2	78,2	59 100	56 900	49 700	59 100	56 900	49 700		18,0	
20,0	79,7	77,7	56 500	56 400	49 600	56 500	56 400	49 600		20,0	
22,0	78,2	77,2	54 200	54 100	49 600	54 200	54 100	49 600		22,0	
24,0	76,7	76,6	52 000	52 000	49 600	52 000	52 000	49 600		24,0	
26,0	75,1	76,0	50 100	50 000	49 600	50 100	50 000	49 600		26,0	
28,0	73,6	75,3	48 300	48 200	48 100	48 300	48 200	48 100		28,0	
30,0	72,0	74,5	46 600	46 600	46 400	46 600	46 600	46 400		30,0	
32,0	70,4	73,7	45 100	45 000	44 900	45 100	45 000	44 900		32,0	
34,0	68,8	72,8	43 700	43 600	43 500	43 700	43 600	43 500		34,0	
36,0	67,1	71,9	42 300	42 300	42 200	42 300	42 300	42 200		36,0	
38,0	65,5	70,8	41 100	41 100	40 900	41 100	41 100	40 900		38,0	
40,0	63,8	69,7	40 000	39 900	39 800	40 000	39 900	39 800		40,0	
42,0	62,1	68,6	38 900	38 900	38 700	38 900	38 900	38 700		42,0	
44,0	60,4	67,3	37 900	37 800	37 700	37 900	37 800	37 700		44,0	
46,0	58,6	65,9	36 900	36 900	36 800	36 900	36 900	36 800		46,0	
48,0	56,8	64,5	36 000	36 000	35 900	36 000	36 000	35 900		48,0	
50,0	54,9	63,0	35 200	35 200	35 100	35 200	35 200	35 100		50,0	
52,0	53,0	61,3	34 400	34 400	34 300	34 400	34 400	34 300		52,0	
54,0	51,0	59,5	33 700	33 500	32 600	33 700	33 700	33 600		54,0	
56,0	49,0	57,6	33 000	32 100	30 900	33 000	33 000	33 000		56,0	
58,0	46,9	55,6	31 400	30 300	29 200	32 400	32 400	32 300		58,0	
60,0	44,7	53,4	29 700	28 700	27 700	31 800	31 800	31 800		60,0	
62,0	42,4	51,0	28 100	27 200	26 300	31 300	31 300	31 200		62,0	
64,0	40,0	48,4	26 600	25 700	24 900	30 800	30 700	30 700		64,0	
66,0	37,4	45,6	25 200	24 400	23 700	30 300	30 300	30 300		66,0	
68,0	34,7	42,5	23 800	23 100	22 500	29 900	29 900	29 900		68,0	
70,0	31,7	39,0	22 400	21 900	21 300	29 600	29 600	29 500		70,0	
72,0	28,4	35,0	21 000	20 600	20 200	29 300	28 900	28 500		72,0	
74,0										74,0	
76,0										76,0	

# MLC300 VPC-MAX S-2



			 10,6 m			 14,6 m						
			 0°			 1°			 2°			
			kg			kg			kg			m
12,2	84,6	85,7	65 000			65 000						12,2
14,0	83,4	85,5	65 000	58 400		65 000	58 400					14,0
16,0	82,0	85,2	65 000	58 100	51 300 <sup>b</sup>	65 000	58 100	51 300 <sup>b</sup>				16,0
18,0	80,6	84,8	64 800	57 900	51 200	64 800	57 900	51 200				18,0
20,0	79,2	84,4	64 500	57 800	51 100	64 500	57 800	51 100				20,0
22,0	77,8	83,9	64 200	57 600	51 000	64 200	57 600	51 000				22,0
24,0	76,4	83,4	63 900	57 400	50 900	63 900	57 400	50 900				24,0
26,0	75,0	82,8	63 700	57 300	50 800	63 700	57 300	50 800				26,0
28,0	73,6	82,1	63 500	57 200	50 800	63 500	57 200	50 800				28,0
30,0	72,1	81,5	63 000	57 100	50 700	63 000	57 100	50 700				30,0
32,0	70,7	80,7	60 800	56 600	50 600	60 800	56 600	50 600				32,0
34,0	69,2	79,9	58 400	55 800	50 500	58 400	55 800	50 500				34,0
36,0	67,7	79,0	56 200	55 100	50 400	56 200	55 100	50 400				36,0
38,0	66,2	78,1	54 100	53 800	50 100	54 100	53 800	50 100				38,0
40,0	64,7	77,1	52 200	51 000	48 200	52 200	51 900	49 600				40,0
42,0	63,2	76,1	50 000	47 600	45 200	50 400	50 200	49 100				42,0
44,0	61,6	74,9	46 900	44 600	42 400	48 800	48 600	48 000				44,0
46,0	60,0	73,7	43 900	41 700	39 700	47 300	47 000	46 700				46,0
48,0	58,4	72,4	41 100	39 200	37 400	45 800	45 600	45 300				48,0
50,0	56,8	71,1	38 600	36 900	35 200	44 500	44 300	44 000				50,0
52,0	55,1	69,6	36 300	34 700	33 200	43 200	43 000	42 700				52,0
54,0	53,4	68,1	34 200	32 800	31 400	42 000	41 900	41 600				54,0
56,0	51,6	66,4	32 200	30 900	29 600	40 900	40 800	40 100				56,0
58,0	49,8	64,7	30 400	29 200	28 000	39 900	39 700	38 300				58,0
60,0	47,9	62,8	28 700	27 600	26 500	38 800	37 800	36 500				60,0
62,0	46,0	60,8	27 200	26 100	25 100	37 100	35 900	34 800				62,0
64,0	44,0	58,7	25 600	24 700	23 800	35 300	34 200	33 100				64,0
66,0	42,0	56,4	24 000	23 300	22 500	33 600	32 600	31 600				66,0
68,0	39,8	53,9	22 600	21 900	21 300	32 000	31 100	30 200				68,0
70,0	37,5	51,2	21 200	20 600	20 000	30 500	29 700	28 800				70,0
72,0	35,1	48,3	20 000	19 400	18 900	29 100	28 400	27 600				72,0
74,0	32,5	45,1	18 700	18 200	17 800	27 800	27 100	26 400				74,0
76,0	29,8	41,5	17 600	17 100	16 700	26 500	25 900	25 200				76,0
78,0	26,7	37,5	16 400	16 100	15 700	25 300	24 700	24 200				78,0
80,0	23,2	32,8	15 400	15 000	14 700	24 100	23 600	23 100				80,0
82,0	19,1	27,1	14 300	14 100	13 800	23 000	22 600	22 100				82,0

# MLC300 VPC-MAX S-2



148  
+  
B60

175 100 kg

360°

72,0 m

12,0 m

20°

m	°	m	10,6 m			14,6 m			m			
			0°			1°				2°		
			kg	kg	kg	kg	kg	kg		kg	kg	kg
12,2											12,2	
14,0	84,7	85,0	61 500			61 500					14,0	
16,0	83,3	84,7	60 900	56 200		60 900	56 200				16,0	
18,0	81,9	84,3	59 900	56 200	48 000	59 900	56 200	48 000			18,0	
20,0	80,5	83,9	57 600	56 100	48 000	57 600	56 100	48 000			20,0	
22,0	79,1	83,4	55 300	55 200	48 000	55 300	55 200	48 000			22,0	
24,0	77,7	82,8	53 300	53 200	48 000	53 300	53 200	48 000			24,0	
26,0	76,2	82,3	51 400	51 300	48 000	51 400	51 300	48 000			26,0	
28,0	74,8	81,6	49 600	49 500	48 000	49 600	49 500	48 000			28,0	
30,0	73,3	80,9	48 000	47 900	47 600	48 000	47 900	47 600			30,0	
32,0	71,9	80,2	46 500	46 400	46 300	46 500	46 400	46 300			32,0	
34,0	70,4	79,4	45 100	45 000	44 900	45 100	45 000	44 900			34,0	
36,0	68,9	78,5	43 700	43 700	43 600	43 700	43 700	43 600			36,0	
38,0	67,4	77,6	42 500	42 500	42 300	42 500	42 500	42 300			38,0	
40,0	65,9	76,6	41 400	41 300	41 200	41 400	41 300	41 200			40,0	
42,0	64,3	75,5	40 300	40 200	40 100	40 300	40 200	40 100			42,0	
44,0	62,7	74,3	39 300	39 200	39 100	39 300	39 200	39 100			44,0	
46,0	61,1	73,1	38 300	38 300	38 200	38 300	38 300	38 200			46,0	
48,0	59,5	71,8	37 400	37 400	37 300	37 400	37 400	37 300			48,0	
50,0	57,9	70,5	36 500	36 300	35 600	36 500	36 500	36 400			50,0	
52,0	56,2	69,0	35 800	35 100	33 600	35 800	35 700	35 600			52,0	
54,0	54,4	67,4	34 600	33 100	31 700	35 000	35 000	34 900			54,0	
56,0	52,6	65,8	32 600	31 300	30 000	34 300	34 300	34 200			56,0	
58,0	50,8	64,0	30 700	29 500	28 300	33 600	33 600	33 500			58,0	
60,0	48,9	62,1	29 000	27 900	26 800	33 000	33 000	32 900			60,0	
62,0	47,0	60,1	27 400	26 400	25 400	32 400	32 400	32 300			62,0	
64,0	45,0	57,9	25 900	24 900	24 000	31 900	31 900	31 800			64,0	
66,0	42,9	55,6	24 300	23 600	22 800	31 400	31 400	31 300			66,0	
68,0	40,7	53,1	22 900	22 200	21 500	30 900	30 700	30 400			68,0	
70,0	38,4	50,4	21 500	20 800	20 300	30 500	29 800	29 000			70,0	
72,0	35,9	47,4	20 100	19 600	19 100	29 300	28 500	27 700			72,0	
74,0	33,3	44,1	18 900	18 400	17 900	27 900	27 200	26 500			74,0	
76,0	30,4	40,5	17 700	17 200	16 800	26 600	26 000	25 300			76,0	
78,0											78,0	
80,0											80,0	
82,0											82,0	



# MLC300 VPC-MAX S-2

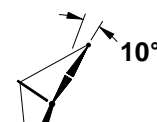
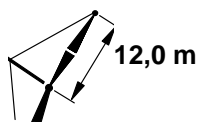
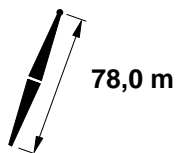

m	°	m	10,6 m			14,6 m			m			
			0°			1°				2°		
			kg	kg	kg	kg	kg	kg		kg	kg	kg
12,2	85,0	91,8	64 700			64 700				12,2		
14,0	83,8	91,6	64 400			64 400				14,0		
16,0	82,5	91,2	64 100	56 200		64 100	56 200			16,0		
18,0	81,3	90,9	63 800	56 100	49 100	63 800	56 100	49 100		18,0		
20,0	80,0	90,5	63 600	55 900	49 100	63 600	55 900	49 100		20,0		
22,0	78,7	90,1	63 300	55 800	49 000	63 300	55 800	49 000		22,0		
24,0	77,4	89,6	63 100	55 700	48 900	63 100	55 700	48 900		24,0		
26,0	76,0	89,0	62 800	55 500	48 800	62 800	55 500	48 800		26,0		
28,0	74,7	88,4	62 600	55 400	48 700	62 600	55 400	48 700		28,0		
30,0	73,4	87,8	62 200	54 700	48 700	62 200	54 700	48 700		30,0		
32,0	72,0	87,1	61 200	53 000	48 600	61 200	53 000	48 600		32,0		
34,0	70,7	86,4	59 100	51 100	47 900	59 100	51 100	47 900		34,0		
36,0	69,3	85,6	57 100	49 400	46 400	57 100	49 400	46 400		36,0		
38,0	67,9	84,7	55 300	47 800	45 000	55 300	47 800	45 000		38,0		
40,0	66,5	83,8	53 200	46 200	43 600	53 500	46 200	43 600		40,0		
42,0	65,1	82,8	49 600	44 800	42 400	51 800	44 800	42 400		42,0		
44,0	63,7	81,8	46 300	43 100	40 800	50 200	43 600	41 200		44,0		
46,0	62,2	80,7	43 300	41 000	38 900	48 700	42 300	40 100		46,0		
48,0	60,8	79,5	40 600	38 500	36 600	47 400	41 200	39 100		48,0		
50,0	59,3	78,3	38 100	36 200	34 400	46 200	40 200	38 200		50,0		
52,0	57,8	77,0	35 800	34 000	32 400	44 900	39 300	37 400		52,0		
54,0	56,2	75,6	33 600	32 100	30 600	43 700	38 500	36 600		54,0		
56,0	54,6	74,1	31 700	30 200	28 800	42 500	37 700	35 900		56,0		
58,0	53,0	72,6	29 900	28 500	27 200	40 600	37 000	35 300		58,0		
60,0	51,4	70,9	28 100	26 900	25 700	38 500	36 300	34 700		60,0		
62,0	49,7	69,2	26 400	25 400	24 300	36 600	35 200	33 700		62,0		
64,0	48,0	67,3	24 800	23 800	22 900	34 800	33 500	32 300		64,0		
66,0	46,2	65,3	23 300	22 400	21 600	33 100	31 900	30 800		66,0		
68,0	44,3	63,2	21 800	21 000	20 300	31 500	30 400	29 400		68,0		
70,0	42,4	60,9	20 500	19 700	19 100	30 000	29 000	28 100		70,0		
72,0	40,4	58,5	19 200	18 500	17 900	28 600	27 700	26 800		72,0		
74,0	38,3	55,9	18 000	17 400	16 800	27 200	26 400	25 600		74,0		
76,0	36,2	53,1	16 800	16 300	15 700	26 000	25 200	24 500		76,0		
78,0	33,8	50,1	15 700	15 200	14 800	24 800	24 100	23 400		78,0		
80,0	31,4	46,7	14 700	14 200	13 800	23 600	23 000	22 400		80,0		
82,0	28,7	43,0	13 700	13 300	12 900	22 500	21 900	21 400		82,0		
84,0	25,7	38,8	12 700	12 400	12 000	21 500	21 000	20 500		84,0		
88,0	18,4	28,0	10 900	10 600	10 400	19 500	19 100	18 700		88,0		

# MLC300 VPC-MAX S-2



148  
+  
B60

175 100 kg

360°

78,0 m

12,0 m

20°

m	°	m	10,6 m			14,6 m			m
			0°	1°	2°	0°	1°	2°	
			kg	kg	kg	kg	kg	kg	
12,2									12,2
14,0									14,0
16,0	83,7	90,7	58 500			58 500			16,0
18,0	82,4	90,4	58 100	54 100		58 100	54 100		18,0
20,0	81,1	90,0	57 600	53 500	46 000	57 600	53 500	46 000	20,0
22,0	79,8	89,5	56 300	53 000	46 000	56 300	53 000	46 000	22,0
24,0	78,5	89,1	54 300	52 500	46 000	54 300	52 500	46 000	24,0
26,0	77,2	88,5	52 400	51 500	46 000	52 400	51 500	46 000	26,0
28,0	75,8	87,9	50 700	50 300	46 000	50 700	50 300	46 000	28,0
30,0	74,5	87,3	49 100	48 800	46 000	49 100	48 800	46 000	30,0
32,0	73,2	86,6	47 500	47 500	45 000	47 500	47 500	45 000	32,0
34,0	71,8	85,8	46 100	46 100	43 700	46 100	46 100	43 700	34,0
36,0	70,4	85,0	44 800	44 800	42 400	44 800	44 800	42 400	36,0
38,0	69,0	84,2	43 600	43 500	41 300	43 600	43 500	41 300	38,0
40,0	67,6	83,2	42 400	42 400	40 200	42 400	42 400	40 200	40,0
42,0	66,2	82,3	41 400	41 300	39 200	41 400	41 300	39 200	42,0
44,0	64,8	81,2	40 300	40 200	38 200	40 300	40 200	38 200	44,0
46,0	63,3	80,1	39 400	39 300	37 300	39 400	39 300	37 300	46,0
48,0	61,8	78,9	38 500	38 400	36 500	38 500	38 400	36 500	48,0
50,0	60,3	77,7	37 600	36 600	34 800	37 600	37 500	35 800	50,0
52,0	58,8	76,4	36 200	34 500	32 800	36 800	36 700	35 100	52,0
54,0	57,2	75,0	34 100	32 500	30 900	36 100	36 000	34 400	54,0
56,0	55,6	73,5	32 100	30 600	29 200	35 400	35 300	33 900	56,0
58,0	54,0	71,9	30 200	28 900	27 600	34 700	34 700	33 300	58,0
60,0	52,3	70,2	28 500	27 300	26 100	34 100	34 000	32 900	60,0
62,0	50,6	68,5	26 800	25 700	24 600	33 500	33 400	32 500	62,0
64,0	48,9	66,6	25 100	24 200	23 300	32 900	32 900	32 200	64,0
66,0	47,1	64,6	23 600	22 700	21 900	32 400	31 900	30 900	66,0
68,0	45,2	62,5	22 100	21 300	20 600	31 600	30 700	29 600	68,0
70,0	43,3	60,2	20 700	20 000	19 300	30 200	29 200	28 300	70,0
72,0	41,3	57,7	19 400	18 800	18 200	28 800	27 900	27 000	72,0
74,0	39,1	55,1	18 200	17 600	17 000	27 400	26 600	25 800	74,0
76,0	36,9	52,2	17 000	16 500	15 900	26 100	25 400	24 600	76,0
78,0	34,6	49,1	15 900	15 400	14 900	24 900	24 200	23 500	78,0
80,0	32,0	45,7	14 800	14 400	13 900	23 700	23 100	22 500	80,0
82,0	29,3	41,9	13 800	13 400	13 000	22 600	22 000	21 500	82,0
84,0									84,0
88,0									88,0

# MLC300 VPC-MAX S-2

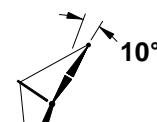
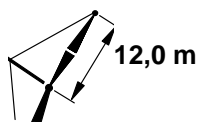
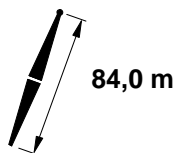

m	°	m	10,6 m			14,6 m			m
			0°			0°			
			kg	kg	kg	kg	kg	kg	
13,7	84,4	97,6	63 400			63 400			13,7
14,0	84,2	97,6	63 400			63 400			14,0
16,0	83,0	97,3	63 100	55 200		63 100	55 200		16,0
18,0	81,8	97,0	62 900	55 000	42 200	62 900	55 000	42 200	18,0
20,0	80,6	96,6	62 700	54 900	42 200	62 700	54 900	42 200	20,0
22,0	79,4	96,2	62 300	54 800	42 200	62 300	54 800	42 200	22,0
24,0	78,2	95,8	61 800	54 700	42 200	61 800	54 700	42 200	24,0
26,0	76,9	95,3	61 300	54 500	42 200	61 300	54 500	42 200	26,0
28,0	75,7	94,7	60 700	53 900	42 200	60 700	53 900	42 200	28,0
30,0	74,5	94,1	60 200	52 100	42 200	60 200	52 100	42 200	30,0
32,0	73,2	93,5	58 500	50 200	42 200	58 500	50 200	42 200	32,0
34,0	71,9	92,8	56 400	48 500	42 200	56 400	48 500	42 200	34,0
36,0	70,7	92,0	54 300	46 900	42 200	54 300	46 900	42 200	36,0
38,0	69,4	91,2	52 400	45 400	42 200	52 400	45 400	42 200	38,0
40,0	68,1	90,4	50 700	43 900	41 400	50 700	43 900	41 400	40,0
42,0	66,8	89,5	48 600	42 600	40 200	49 000	42 600	40 200	42,0
44,0	65,5	88,5	45 600	41 300	39 100	47 500	41 300	39 100	44,0
46,0	64,1	87,5	42 600	40 000	37 800	46 100	40 100	38 000	46,0
48,0	62,8	86,5	39 800	37 600	35 500	44 700	39 000	37 000	48,0
50,0	61,4	85,3	37 300	35 300	33 400	43 500	38 000	36 100	50,0
52,0	60,0	84,1	35 000	33 100	31 400	42 300	37 000	35 200	52,0
54,0	58,6	82,9	32 900	31 200	29 600	41 300	36 100	34 400	54,0
56,0	57,2	81,5	30 900	29 300	27 900	40 300	35 300	33 700	56,0
58,0	55,7	80,1	28 900	27 600	26 200	39 400	34 500	33 000	58,0
60,0	54,2	78,6	27 100	25 900	24 700	37 800	33 900	32 300	60,0
62,0	52,7	77,0	25 300	24 200	23 200	35 800	33 200	31 700	62,0
64,0	51,2	75,4	23 700	22 700	21 700	34 000	32 600	31 200	64,0
66,0	49,6	73,6	22 200	21 300	20 300	32 300	31 100	29 800	66,0
68,0	48,0	71,8	20 800	19 900	19 100	30 700	29 600	28 400	68,0
70,0	46,3	69,8	19 400	18 600	17 800	29 200	28 100	27 100	70,0
72,0	44,6	67,7	18 100	17 400	16 700	27 800	26 800	25 800	72,0
74,0	42,8	65,5	16 900	16 200	15 600	26 500	25 600	24 600	74,0
76,0	41,0	63,1	15 800	15 100	14 500	25 200	24 300	23 500	76,0
78,0	39,0	60,6	14 700	14 100	13 500	24 000	23 200	22 400	78,0
80,0	37,0	57,9	13 600	13 100	12 600	22 900	22 100	21 400	80,0
82,0	34,9	55,0	12 600	12 200	11 700	21 800	21 100	20 400	82,0
84,0	32,7	51,8	11 700	11 300	10 800	20 800	20 100	19 500	84,0
88,0	27,7	44,4	9 900	9 600	9 200	18 800	18 300	17 800	88,0
92,0	21,6	35,0	8 200			17 000			92,0

# MLC300 VPC-MAX S-2



148  
+  
B60

175 100 kg

360°

84,0 m

12,0 m

20°

m	°	m	10,6 m			14,6 m			m			
			0°			1°				2°		
			kg	kg	kg	kg	kg	kg		kg	kg	kg
13,7										13,7		
14,0										14,0		
16,0	84,1	96,8	56 400			56 400				16,0		
18,0	82,9	96,5	56 000	53 200		56 000	53 200			18,0		
20,0	81,7	96,1	55 700	53 000	40 000	55 700	53 000	40 000		20,0		
22,0	80,5	95,7	55 300	52 500	40 000	55 300	52 500	40 000		22,0		
24,0	79,2	95,2	54 900	51 300	40 000	54 900	51 300	40 000		24,0		
26,0	78,0	94,7	53 400	49 700	40 000	53 400	49 700	40 000		26,0		
28,0	76,8	94,2	51 700	48 200	40 000	51 700	48 200	40 000		28,0		
30,0	75,5	93,6	50 100	46 700	40 000	50 100	46 700	40 000		30,0		
32,0	74,3	92,9	48 600	45 200	40 000	48 600	45 200	40 000		32,0		
34,0	73,0	92,2	47 200	43 900	40 000	47 200	43 900	40 000		34,0		
36,0	71,7	91,5	45 900	42 600	39 900	45 900	42 600	39 900		36,0		
38,0	70,4	90,7	44 700	41 400	39 100	44 700	41 400	39 100		38,0		
40,0	69,1	89,8	43 500	40 200	38 100	43 500	40 200	38 100		40,0		
42,0	67,8	88,9	42 500	39 100	37 100	42 500	39 100	37 100		42,0		
44,0	66,5	88,0	41 500	38 100	36 200	41 500	38 100	36 200		44,0		
46,0	65,1	86,9	40 500	37 100	35 300	40 500	37 100	35 300		46,0		
48,0	63,8	85,9	39 600	36 200	34 500	39 600	36 200	34 500		48,0		
50,0	62,4	84,7	37 800	35 000	33 300	38 700	35 400	33 700		50,0		
52,0	61,0	83,5	35 500	33 600	31 800	37 900	34 600	33 000		52,0		
54,0	59,6	82,2	33 300	31 600	30 000	37 200	33 900	32 300		54,0		
56,0	58,1	80,9	31 300	29 800	28 300	36 400	33 200	31 700		56,0		
58,0	56,7	79,5	29 400	28 000	26 600	35 700	32 600	31 100		58,0		
60,0	55,2	78,0	27 600	26 300	25 100	35 100	32 000	30 600		60,0		
62,0	53,6	76,4	25 800	24 700	23 600	34 500	31 400	30 100		62,0		
64,0	52,1	74,7	24 100	23 100	22 100	33 900	30 900	29 600		64,0		
66,0	50,5	72,9	22 600	21 600	20 700	32 600	30 500	29 300		66,0		
68,0	48,8	71,1	21 100	20 300	19 400	31 000	29 700	28 500		68,0		
70,0	47,2	69,1	19 700	18 900	18 100	29 500	28 400	27 300		70,0		
72,0	45,4	67,0	18 400	17 700	17 000	28 100	27 100	26 100		72,0		
74,0	43,6	64,7	17 200	16 500	15 900	26 700	25 800	24 900		74,0		
76,0	41,7	62,3	16 000	15 400	14 800	25 400	24 500	23 700		76,0		
78,0	39,8	59,8	14 900	14 300	13 800	24 200	23 400	22 600		78,0		
80,0	37,8	57,0	13 900	13 300	12 800	23 000	22 300	21 600		80,0		
82,0	35,6	54,0	12 800	12 300	11 900	21 900	21 200	20 600		82,0		
84,0	33,3	50,8	11 900	11 400	11 000	20 900	20 300	19 600		84,0		
88,0	28,2	43,2	10 000	9 700	9 300	18 900	18 400	17 900		88,0		
92,0										92,0		

# MLC300 VPC-MAX S-2

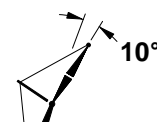
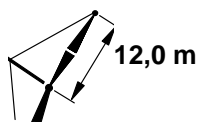
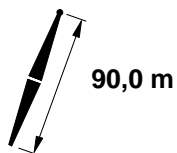

m	°	m	10,6 m			14,6 m			m			
			0°			1°				2°		
			kg	kg	kg	kg	kg	kg		kg	kg	
13,7	84,7	103,7	61 200			61 200			13,7			
14,0	84,6	103,7	61 100			61 100			14,0			
16,0	83,4	103,4	60 600	46 600		60 600	46 600		16,0			
18,0	82,3	103,1	60 100	46 600	35 100	60 100	46 600	35 100	18,0			
20,0	81,2	102,7	59 700	46 600	35 100	59 700	46 600	35 100	20,0			
22,0	80,0	102,3	59 200	46 600	35 100	59 200	46 600	35 100	22,0			
24,0	78,9	101,9	58 700	46 600	35 100	58 700	46 600	35 100	24,0			
26,0	77,7	101,4	58 300	46 600	35 100	58 300	46 600	35 100	26,0			
28,0	76,6	100,9	57 400	46 600	35 100	57 400	46 600	35 100	28,0			
30,0	75,4	100,4	55 500	46 600	35 100	55 500	46 600	35 100	30,0			
32,0	74,2	99,8	53 400	45 900	35 100	53 400	45 900	35 100	32,0			
34,0	73,0	99,1	51 500	44 400	35 100	51 500	44 400	35 100	34,0			
36,0	71,9	98,4	49 600	42 900	35 100	49 600	42 900	35 100	36,0			
38,0	70,7	97,7	47 900	41 500	35 100	47 900	41 500	35 100	38,0			
40,0	69,5	96,9	46 300	40 200	35 100	46 300	40 200	35 100	40,0			
42,0	68,2	96,1	44 800	38 900	35 100	44 800	38 900	35 100	42,0			
44,0	67,0	95,2	43 300	37 800	35 000	43 300	37 800	35 000	44,0			
46,0	65,8	94,2	41 900	36 700	34 700	42 000	36 700	34 700	46,0			
48,0	64,5	93,2	39 600	35 600	33 700	40 800	35 600	33 700	48,0			
50,0	63,3	92,2	37 100	34 300	32 400	39 600	34 600	32 800	50,0			
52,0	62,0	91,1	34 800	32 800	30 900	38 500	33 700	32 000	52,0			
54,0	60,7	89,9	32 700	30 800	29 100	37 500	32 800	31 200	54,0			
56,0	59,4	88,7	30 600	29 000	27 400	36 500	32 000	30 500	56,0			
58,0	58,0	87,4	28 600	27 100	25 800	35 600	31 200	29 800	58,0			
60,0	56,7	86,0	26 800	25 400	24 200	34 700	30 500	29 100	60,0			
62,0	55,3	84,6	25 000	23 800	22 600	33 900	29 800	28 500	62,0			
64,0	53,9	83,1	23 400	22 300	21 200	33 200	29 200	27 900	64,0			
66,0	52,5	81,5	21 900	20 800	19 800	32 100	28 600	27 400	66,0			
68,0	51,0	79,9	20 500	19 500	18 600	30 500	28 100	26 900	68,0			
70,0	49,5	78,1	19 100	18 200	17 300	29 000	27 600	26 400	70,0			
72,0	48,0	76,3	17 800	17 000	16 200	27 600	26 400	25 400	72,0			
74,0	46,4	74,3	16 600	15 900	15 100	26 300	25 200	24 200	74,0			
76,0	44,8	72,2	15 500	14 800	14 100	25 000	24 000	23 100	76,0			
78,0	43,2	70,0	14 400	13 700	13 100	23 800	22 900	22 100	78,0			
80,0	41,4	67,7	13 400	12 700	12 200	22 700	21 800	21 000	80,0			
82,0	39,7	65,2	12 400	11 800	11 300	21 600	20 800	20 100	82,0			
84,0	37,8	62,6	11 400	10 900	10 400	20 600	19 900	19 100	84,0			
88,0	33,8	56,7	9 700	9 200	8 800	18 600	18 000	17 400	88,0			
92,0	29,3	49,8	8 000	7 700	7 300	16 900	16 400	15 800	92,0			
96,0	24,0	41,3	6 500	6 200	6 000	15 300	14 800	14 400	96,0			

# MLC300 VPC-MAX S-2



148  
+  
B60

175 100 kg

360°

90,0 m

12,0 m

20°

m	°	m	10,6 m			14,6 m			m			
			0°			1°				2°		
			kg	kg	kg	kg	kg	kg		kg	kg	
13,7									13,7			
14,0									14,0			
16,0	84,5	102,9	53 600			53 600			16,0			
18,0	83,3	102,6	53 300			53 300			18,0			
20,0	82,2	102,2	53 000			53 000			20,0			
22,0	81,0	101,8	52 700	44 500	33 500	52 700	44 500	33 500	22,0			
24,0	79,9	101,4	52 300	44 500	33 500	52 300	44 500	33 500	24,0			
26,0	78,7	100,9	52 000	44 500	33 500	52 000	44 500	33 500	26,0			
28,0	77,6	100,4	51 100	44 100	33 500	51 100	44 100	33 500	28,0			
30,0	76,4	99,8	49 400	42 800	33 500	49 400	42 800	33 500	30,0			
32,0	75,2	99,2	47 800	41 500	33 500	47 800	41 500	33 500	32,0			
34,0	74,0	98,6	46 300	40 200	33 500	46 300	40 200	33 500	34,0			
36,0	72,8	97,9	44 800	39 000	33 500	44 800	39 000	33 500	36,0			
38,0	71,6	97,1	43 500	37 900	33 500	43 500	37 900	33 500	38,0			
40,0	70,4	96,3	42 200	36 800	33 500	42 200	36 800	33 500	40,0			
42,0	69,2	95,5	41 000	35 800	33 500	41 000	35 800	33 500	42,0			
44,0	68,0	94,6	39 800	34 800	33 000	39 800	34 800	33 000	44,0			
46,0	66,7	93,7	38 700	33 900	32 200	38 700	33 900	32 200	46,0			
48,0	65,5	92,7	37 700	33 100	31 400	37 700	33 100	31 400	48,0			
50,0	64,2	91,6	36 700	32 200	30 700	36 700	32 200	30 700	50,0			
52,0	62,9	90,5	35 300	31 500	29 900	35 300	31 500	30 000	52,0			
54,0	61,6	89,3	33 100	30 700	29 100	34 900	30 700	29 300	54,0			
56,0	60,3	88,1	31 100	29 400	27 800	34 100	30 000	28 700	56,0			
58,0	58,9	86,8	29 100	27 700	26 200	33 400	29 400	28 100	58,0			
60,0	57,6	85,4	27 300	25 900	24 600	32 700	28 800	27 500	60,0			
62,0	56,2	84,0	25 500	24 300	23 100	32 000	28 200	27 000	62,0			
64,0	54,8	82,5	23 900	22 700	21 600	31 400	27 700	26 500	64,0			
66,0	53,3	80,9	22 300	21 300	20 200	30 800	27 200	26 100	66,0			
68,0	51,8	79,2	20 900	19 900	18 900	30 300	26 800	25 700	68,0			
70,0	50,3	77,4	19 500	18 600	17 700	29 300	26 300	25 300	70,0			
72,0	48,8	75,5	18 200	17 300	16 500	27 900	25 900	24 900	72,0			
74,0	47,2	73,6	16 900	16 200	15 400	26 500	25 300	24 300	74,0			
76,0	45,6	71,5	15 800	15 100	14 400	25 200	24 300	23 300	76,0			
78,0	43,9	69,3	14 700	14 000	13 400	24 000	23 100	22 300	78,0			
80,0	42,2	66,9	13 600	13 000	12 400	22 900	22 000	21 200	80,0			
82,0	40,4	64,4	12 600	12 000	11 500	21 800	21 000	20 200	82,0			
84,0	38,5	61,7	11 600	11 100	10 600	20 700	20 000	19 300	84,0			
88,0	34,4	55,8	9 800	9 400	9 000	18 800	18 100	17 500	88,0			
92,0	29,9	48,7	8 100	7 800	7 400	17 000	16 400	15 900	92,0			
96,0									96,0			

# MLC300 VPC-MAX S-2

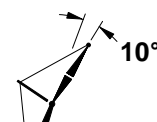
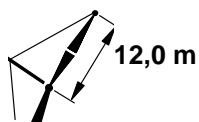
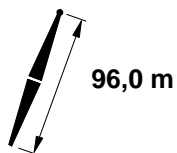

m	°	m	10,6 m			14,6 m			m			
			0°			1°				2°		
			kg	kg	kg	kg	kg	kg		kg	kg	
15,2	84,2	109,5	58 000			58 000			15,2			
16,0	83,8	109,5	57 900			57 900			16,0			
18,0	82,7	109,2	57 400	39 600		57 400	39 600		18,0			
20,0	81,7	108,8	57 000	39 600	29 600	57 000	39 600	29 600	20,0			
22,0	80,6	108,5	56 600	39 600	29 600	56 600	39 600	29 600	22,0			
24,0	79,5	108,1	56 200	39 600	29 600	56 200	39 600	29 600	24,0			
26,0	78,4	107,6	55 800	39 600	29 600	55 800	39 600	29 600	26,0			
28,0	77,3	107,1	55 400	39 600	29 600	55 400	39 600	29 600	28,0			
30,0	76,2	106,6	55 000	39 600	29 600	55 000	39 600	29 600	30,0			
32,0	75,1	106,0	54 600	39 600	29 600	54 600	39 600	29 600	32,0			
34,0	74,0	105,4	54 300	39 600	29 600	54 300	39 600	29 600	34,0			
36,0	72,9	104,8	53 500	39 600	29 600	53 500	39 600	29 600	36,0			
38,0	71,8	104,1	51 900	39 600	29 600	51 900	39 600	29 600	38,0			
40,0	70,7	103,4	50 400	39 600	29 600	50 400	39 600	29 600	40,0			
42,0	69,5	102,6	48 000	39 600	29 600	48 900	39 600	29 600	42,0			
44,0	68,4	101,7	44 600	39 400	29 600	47 500	39 600	29 600	44,0			
46,0	67,2	100,9	41 600	38 900	29 600	46 100	39 500	29 600	46,0			
48,0	66,1	99,9	38 900	36 400	29 600	44 800	38 800	29 600	48,0			
50,0	64,9	99,0	36 400	34 100	29 500	43 600	37 900	29 500	50,0			
52,0	63,7	97,9	34 000	31 900	29 300	42 500	37 000	29 500	52,0			
54,0	62,5	96,9	31 700	29 800	27 900	41 400	36 100	29 400	54,0			
56,0	61,3	95,7	29 500	27 900	26 300	40 400	35 300	29 300	56,0			
58,0	60,0	94,5	27 600	26 000	24 500	38 900	34 400	29 300	58,0			
60,0	58,8	93,3	25 700	24 300	22 900	36 800	33 700	29 200	60,0			
62,0	57,5	92,0	24 000	22 700	21 400	34 900	32 700	29 200	62,0			
64,0	56,2	90,6	22 400	21 100	20 000	33 000	31 400	29 100	64,0			
66,0	54,9	89,1	20 900	19 700	18 600	31 300	29 900	28 200	66,0			
68,0	53,6	87,6	19 400	18 400	17 300	29 800	28 400	27 100	68,0			
70,0	52,2	86,0	18 100	17 100	16 100	28 300	27 000	25 700	70,0			
72,0	50,9	84,3	16 800	15 900	15 000	26 800	25 700	24 500	72,0			
74,0	49,4	82,6	15 600	14 700	13 900	25 500	24 400	23 300	74,0			
76,0	48,0	80,7	14 400	13 600	12 900	24 200	23 200	22 200	76,0			
78,0	46,5	78,8	13 400	12 600	11 900	23 100	22 100	21 100	78,0			
80,0	45,0	76,7	12 300	11 600	11 000	21 900	21 000	20 100	80,0			
82,0	43,5	74,6	11 300	10 700	10 100	20 800	20 000	19 100	82,0			
84,0	41,8	72,3	10 400	9 800	9 200	19 800	19 000	18 200	84,0			
88,0	38,5	67,3	8 600	8 100	7 600	17 900	17 200	16 500	88,0			
92,0	34,8	61,6	7 000	6 600	6 200	16 100	15 500	14 900	92,0			
96,0	30,7	55,0	5 500	5 200	4 800	14 500	14 000	13 500	96,0			
100,0	26,0	47,1	4 100	3 800	3 600	13 000	12 600	12 200	100,0			
104,0	20,3	37,0				11 600			104,0			

# MLC300 VPC-MAX S-2



148  
+  
B60

175 100 kg

360°

96,0 m

12,0 m

20°

m	°	m	10,6 m			14,6 m			m			
			0°			1°				2°		
			kg	kg	kg	kg	kg	kg		kg	kg	kg
15,2										15,2		
16,0										16,0		
18,0	83,7	108,6	51 100			51 100				18,0		
20,0	82,6	108,3	50 800	38 000	28 300	50 800	38 000	28 300		20,0		
22,0	81,5	107,9	50 500	38 000	28 300	50 500	38 000	28 300		22,0		
24,0	80,5	107,5	50 200	38 000	28 300	50 200	38 000	28 300		24,0		
26,0	79,4	107,1	49 900	38 000	28 300	49 900	38 000	28 300		26,0		
28,0	78,3	106,6	49 700	38 000	28 300	49 700	38 000	28 300		28,0		
30,0	77,2	106,1	49 400	38 000	28 300	49 400	38 000	28 300		30,0		
32,0	76,1	105,5	49 200	38 000	28 300	49 200	38 000	28 300		32,0		
34,0	75,0	104,9	48 800	38 000	28 300	48 800	38 000	28 300		34,0		
36,0	73,8	104,2	47 800	38 000	28 300	47 800	38 000	28 300		36,0		
38,0	72,7	103,5	46 700	38 000	28 300	46 700	38 000	28 300		38,0		
40,0	71,6	102,8	45 500	38 000	28 300	45 500	38 000	28 300		40,0		
42,0	70,4	102,0	44 400	38 000	28 300	44 400	38 000	28 300		42,0		
44,0	69,3	101,2	43 200	37 500	28 300	43 200	37 500	28 300		44,0		
46,0	68,1	100,3	42 000	36 800	28 300	42 200	36 800	28 300		46,0		
48,0	66,9	99,4	39 500	35 900	28 300	41 100	35 900	28 300		48,0		
50,0	65,8	98,4	36 900	34 400	28 300	40 200	35 100	28 300		50,0		
52,0	64,6	97,3	34 600	32 500	28 300	39 200	34 300	28 300		52,0		
54,0	63,4	96,3	32 300	30 400	28 000	38 300	33 600	28 300		54,0		
56,0	62,1	95,1	30 200	28 500	26 800	37 500	32 900	28 200		56,0		
58,0	60,9	93,9	28 200	26 600	25 100	36 700	32 200	28 200		58,0		
60,0	59,6	92,7	26 300	24 800	23 500	36 000	31 600	28 200		60,0		
62,0	58,4	91,3	24 500	23 200	21 900	35 100	31 000	28 100		62,0		
64,0	57,1	89,9	22 900	21 600	20 400	33 400	30 500	28 100		64,0		
66,0	55,7	88,5	21 300	20 200	19 100	31 700	29 800	28 100		66,0		
68,0	54,4	86,9	19 900	18 800	17 800	30 100	28 700	27 400		68,0		
70,0	53,0	85,3	18 500	17 500	16 500	28 600	27 300	26 000		70,0		
72,0	51,6	83,7	17 200	16 300	15 400	27 100	26 000	24 800		72,0		
74,0	50,2	81,9	16 000	15 100	14 300	25 800	24 700	23 600		74,0		
76,0	48,8	80,0	14 800	14 000	13 200	24 500	23 500	22 400		76,0		
78,0	47,3	78,0	13 700	12 900	12 200	23 300	22 300	21 400		78,0		
80,0	45,7	76,0	12 600	11 900	11 300	22 100	21 200	20 300		80,0		
82,0	44,2	73,8	11 600	11 000	10 300	21 100	20 200	19 400		82,0		
84,0	42,5	71,5	10 700	10 100	9 500	20 000	19 200	18 400		84,0		
88,0	39,1	66,4	8 900	8 300	7 800	18 100	17 400	16 700		88,0		
92,0	35,4	60,6	7 200	6 800	6 300	16 300	15 700	15 100		92,0		
96,0	31,2	53,9	5 700	5 300	4 900	14 600	14 100	13 600		96,0		
100,0										100,0		
104,0										104,0		



# MLC300 VPC-MAX S-2

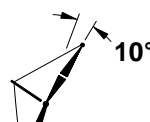
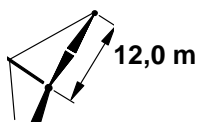
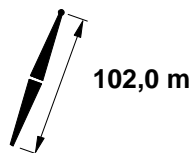

			10,6 m		14,6 m			
			0°		1°			
m	°	m	kg	kg	kg	kg	m	
15,2	84,5	115,6	50 800		50 800		15,2	
16,0	84,1	115,5	50 800		50 800		16,0	
18,0	83,1	115,2	50 800	32 400	50 800	32 400	18,0	
20,0	82,1	114,9	50 800	32 400	50 800	32 400	20,0	
22,0	81,1	114,5	50 800	32 400	50 800	32 400	22,0	
24,0	80,1	114,2	50 800	32 400	50 800	32 400	24,0	
26,0	79,0	113,7	50 800	32 400	50 800	32 400	26,0	
28,0	78,0	113,3	49 900	32 400	49 900	32 400	28,0	
30,0	77,0	112,8	48 200	32 400	48 200	32 400	30,0	
32,0	75,9	112,3	46 500	32 400	46 500	32 400	32,0	
34,0	74,9	111,7	45 000	32 400	45 000	32 400	34,0	
36,0	73,8	111,1	43 500	32 400	43 500	32 400	36,0	
38,0	72,8	110,4	42 000	32 400	42 000	32 400	38,0	
40,0	71,7	109,7	40 600	32 400	40 600	32 400	40,0	
42,0	70,6	109,0	39 300	32 400	39 300	32 400	42,0	
44,0	69,6	108,2	38 100	32 300	38 100	32 300	44,0	
46,0	68,5	107,4	36 900	32 100	36 900	32 100	46,0	
48,0	67,4	106,5	35 800	31 200	35 800	31 200	48,0	
50,0	66,3	105,6	34 700	30 300	34 700	30 300	50,0	
52,0	65,2	104,6	33 500	29 400	33 700	29 400	52,0	
54,0	64,1	103,6	31 200	28 600	32 800	28 600	54,0	
56,0	62,9	102,6	29 100	27 300	31 900	27 900	56,0	
58,0	61,8	101,5	27 100	25 400	31 000	27 100	58,0	
60,0	60,6	100,3	25 300	23 700	30 200	26 400	60,0	
62,0	59,4	99,1	23 600	22 100	29 500	25 800	62,0	
64,0	58,2	97,8	21 900	20 600	28 700	25 200	64,0	
66,0	57,0	96,5	20 400	19 200	28 100	24 600	66,0	
68,0	55,8	95,1	19 000	17 800	27 400	24 000	68,0	
70,0	54,6	93,6	17 600	16 600	26 800	23 500	70,0	
72,0	53,3	92,1	16 400	15 400	26 200	23 000	72,0	
74,0	52,0	90,5	15 200	14 200	25 200	22 500	74,0	
76,0	50,7	88,8	14 000	13 100	23 900	22 000	76,0	
78,0	49,4	87,0	12 900	12 100	22 800	21 400	78,0	
80,0	48,0	85,2	11 900	11 200	21 600	20 600	80,0	
82,0	46,6	83,2	10 900	10 200	20 500	19 600	82,0	
84,0	45,2	81,2	10 000	9 300	19 500	18 700	84,0	
88,0	42,2	76,8	8 200	7 700	17 600	16 800	88,0	
92,0	39,0	71,9	6 600	6 100	15 900	15 200	92,0	
96,0	35,6	66,4	5 200	4 700	14 300	13 700	96,0	
100,0	31,8	60,0	3 800	3 400	12 800	12 300	100,0	
104,0	27,6	52,6			11 400	11 000	104,0	
108,0	22,6	43,5			10 100	9 800	108,0	

# MLC300 VPC-MAX S-2

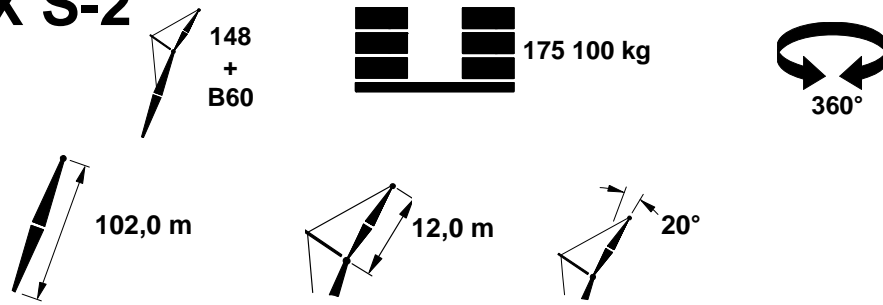

m	°	m	10,6 m		14,6 m		m
			0°		1°		
			kg	kg	kg	kg	
15,2							15,2
16,0							16,0
18,0	84,0	114,7	48 000		48 000		18,0
20,0	83,0	114,4	47 800	31 300	47 800	31 300	20,0
22,0	82,0	114,0	47 500	31 300	47 500	31 300	22,0
24,0	81,0	113,6	47 200	31 300	47 200	31 300	24,0
26,0	79,9	113,2	45 900	31 300	45 900	31 300	26,0
28,0	78,9	112,7	44 500	31 300	44 500	31 300	28,0
30,0	77,9	112,2	43 100	31 300	43 100	31 300	30,0
32,0	76,8	111,7	41 800	31 300	41 800	31 300	32,0
34,0	75,8	111,1	40 600	31 300	40 600	31 300	34,0
36,0	74,7	110,5	39 300	31 300	39 300	31 300	36,0
38,0	73,7	109,9	38 200	31 300	38 200	31 300	38,0
40,0	72,6	109,2	37 000	31 200	37 000	31 200	40,0
42,0	71,5	108,4	36 000	31 100	36 000	31 100	42,0
44,0	70,4	107,6	35 000	30 500	35 000	30 500	44,0
46,0	69,3	106,8	34 000	29 700	34 000	29 700	46,0
48,0	68,2	105,9	33 100	28 900	33 100	28 900	48,0
50,0	67,1	105,0	32 200	28 200	32 200	28 200	50,0
52,0	66,0	104,1	31 300	27 400	31 300	27 400	52,0
54,0	64,9	103,0	30 600	26 800	30 600	26 800	54,0
56,0	63,7	102,0	29 600	26 100	29 800	26 100	56,0
58,0	62,6	100,9	27 700	25 500	29 100	25 500	58,0
60,0	61,4	99,7	25 900	24 100	28 400	24 900	60,0
62,0	60,2	98,5	24 100	22 700	27 700	24 300	62,0
64,0	59,0	97,2	22 500	21 100	27 100	23 800	64,0
66,0	57,8	95,8	20 900	19 700	26 500	23 300	66,0
68,0	56,6	94,4	19 500	18 300	26 000	22 800	68,0
70,0	55,3	92,9	18 100	17 000	25 400	22 400	70,0
72,0	54,1	91,4	16 800	15 800	24 900	21 900	72,0
74,0	52,8	89,8	15 600	14 600	24 500	21 500	74,0
76,0	51,5	88,1	14 400	13 500	24 000	21 100	76,0
78,0	50,1	86,3	13 300	12 500	23 000	20 700	78,0
80,0	48,7	84,4	12 200	11 500	21 900	20 300	80,0
82,0	47,3	82,5	11 200	10 500	20 800	19 800	82,0
84,0	45,9	80,4	10 300	9 600	19 700	18 900	84,0
88,0	42,9	76,0	8 500	7 900	17 800	17 000	88,0
92,0	39,6	71,0	6 900	6 300	16 000	15 300	92,0
96,0	36,2	65,4	5 300	4 900	14 400	13 800	96,0
100,0	32,4	59,0	3 900	3 600	12 900	12 400	100,0
104,0	28,0	51,4			11 500		104,0
108,0							108,0

# MLC300 VPC-MAX S-2

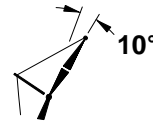
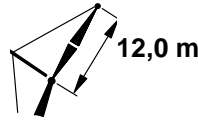
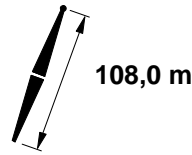

m	°	m	10,6 m		14,6 m		m
			0°		1°		
			kg	kg	kg	kg	
15,2	84,8	121,6	44 800		44 800		15,2
16,0	84,4	121,5	44 800		44 800		16,0
18,0	83,5	121,3	44 800		44 800		18,0
20,0	82,5	121,0	44 800	27 200	44 800	27 200	20,0
22,0	81,5	120,6	44 800	27 200	44 800	27 200	22,0
24,0	80,6	120,3	44 800	27 200	44 800	27 200	24,0
26,0	79,6	119,9	44 800	27 200	44 800	27 200	26,0
28,0	78,6	119,4	44 800	27 200	44 800	27 200	28,0
30,0	77,6	119,0	44 700	27 200	44 700	27 200	30,0
32,0	76,6	118,5	43 400	27 200	43 400	27 200	32,0
34,0	75,7	117,9	41 800	27 200	41 800	27 200	34,0
36,0	74,7	117,3	40 300	27 200	40 300	27 200	36,0
38,0	73,7	116,7	38 900	27 200	38 900	27 200	38,0
40,0	72,7	116,1	37 500	27 200	37 500	27 200	40,0
42,0	71,7	115,4	36 200	27 200	36 200	27 200	42,0
44,0	70,6	114,6	34 900	27 200	34 900	27 200	44,0
46,0	69,6	113,9	33 700	27 200	33 700	27 200	46,0
48,0	68,6	113,1	32 600	27 200	32 600	27 200	48,0
50,0	67,6	112,2	31 500	26 700	31 500	26 700	50,0
52,0	66,5	111,3	30 500	25 900	30 500	25 900	52,0
54,0	65,5	110,3	29 600	25 100	29 600	25 100	54,0
56,0	64,4	109,3	28 100	24 400	28 700	24 400	56,0
58,0	63,3	108,3	26 100	23 600	27 800	23 600	58,0
60,0	62,2	107,2	24 300	22 400	27 000	23 000	60,0
62,0	61,1	106,1	22 500	21 000	26 200	22 300	62,0
64,0	60,0	104,9	20 900	19 500	25 500	21 700	64,0
66,0	58,9	103,6	19 400	18 100	24 800	21 200	66,0
68,0	57,8	102,3	18 000	16 700	24 200	20 600	68,0
70,0	56,6	101,0	16 600	15 500	23 500	20 100	70,0
72,0	55,4	99,6	15 300	14 300	22 900	19 600	72,0
74,0	54,3	98,1	14 100	13 100	22 400	19 200	74,0
76,0	53,1	96,6	13 000	12 000	21 900	18 700	76,0
78,0	51,8	94,9	11 900	11 000	21 400	18 300	78,0
80,0	50,6	93,3	10 900	10 100	20 800	17 900	80,0
82,0	49,3	91,5	9 900	9 100	19 800	17 600	82,0
84,0	48,0	89,6	9 000	8 300	18 800	17 200	84,0
88,0	45,3	85,7	7 200	6 600	16 900	16 000	88,0
92,0	42,5	81,3	5 600	5 100	15 100	14 400	92,0
96,0	39,5	76,5	4 200	3 700	13 500	12 900	96,0
100,0	36,3	71,1			12 100	11 500	100,0
104,0	32,9	65,0			10 700	10 200	104,0
108,0	29,0	58,0			9 400	9 000	108,0
112,0	24,6	49,6			8 300	7 900	112,0
116,0	19,1	38,9			7 100		116,0



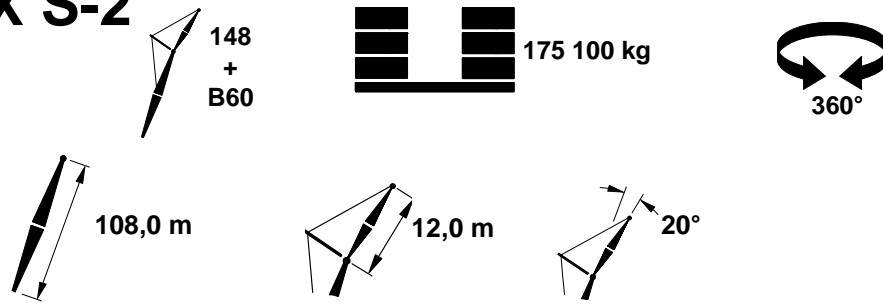



# MLC300 VPC-MAX S-2

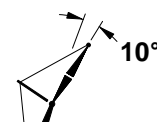
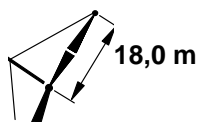
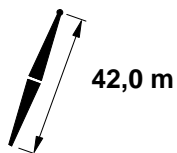

m	°	m	10,6 m		14,6 m		m
			0°		1°		
			kg	kg	kg	kg	
15,2							15,2
16,0							16,0
18,0	84,3	120,7	43 500		43 500		18,0
20,0	83,4	120,4	43 500	26 400	43 500	26 400	20,0
22,0	82,4	120,1	43 500	26 400	43 500	26 400	22,0
24,0	81,4	119,7	43 500	26 400	43 500	26 400	24,0
26,0	80,5	119,3	43 500	26 400	43 500	26 400	26,0
28,0	79,5	118,9	42 600	26 400	42 600	26 400	28,0
30,0	78,5	118,4	41 200	26 400	41 200	26 400	30,0
32,0	77,5	117,9	39 800	26 400	39 800	26 400	32,0
34,0	76,5	117,4	38 500	26 400	38 500	26 400	34,0
36,0	75,5	116,8	37 200	26 400	37 200	26 400	36,0
38,0	74,5	116,2	36 000	26 400	36 000	26 400	38,0
40,0	73,5	115,5	34 800	26 400	34 800	26 400	40,0
42,0	72,5	114,8	33 700	26 400	33 700	26 400	42,0
44,0	71,5	114,1	32 600	26 400	32 600	26 400	44,0
46,0	70,4	113,3	31 600	26 400	31 600	26 400	46,0
48,0	69,4	112,5	30 600	25 900	30 600	25 900	48,0
50,0	68,4	111,6	29 700	25 200	29 700	25 200	50,0
52,0	67,3	110,7	28 800	24 500	28 800	24 500	52,0
54,0	66,3	109,8	27 900	23 800	27 900	23 800	54,0
56,0	65,2	108,8	27 100	23 200	27 100	23 200	56,0
58,0	64,1	107,7	26 400	22 500	26 400	22 500	58,0
60,0	63,0	106,6	24 900	21 900	25 700	21 900	60,0
62,0	61,9	105,5	23 100	21 100	25 000	21 400	62,0
64,0	60,8	104,3	21 500	20 000	24 300	20 800	64,0
66,0	59,7	103,0	19 900	18 600	23 700	20 300	66,0
68,0	58,5	101,7	18 500	17 200	23 100	19 800	68,0
70,0	57,4	100,3	17 100	15 900	22 600	19 300	70,0
72,0	56,2	98,9	15 800	14 700	22 000	18 900	72,0
74,0	55,0	97,4	14 600	13 600	21 600	18 500	74,0
76,0	53,8	95,9	13 400	12 500	21 100	18 100	76,0
78,0	52,5	94,3	12 300	11 400	20 700	17 700	78,0
80,0	51,3	92,6	11 300	10 400	20 200	17 300	80,0
82,0	50,0	90,8	10 300	9 500	19 900	17 000	82,0
84,0	48,7	88,9	9 300	8 600	19 000	16 700	84,0
88,0	46,0	84,9	7 500	6 900	17 100	16 100	88,0
92,0	43,2	80,5	5 900	5 300	15 300	14 600	92,0
96,0	40,1	75,7	4 400	3 900	13 700	13 000	96,0
100,0	36,9	70,2			12 200	11 600	100,0
104,0	33,4	64,0			10 800	10 300	104,0
108,0	29,4	56,9			9 500	9 100	108,0
112,0							112,0
116,0							116,0

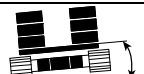
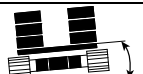
# MLC300 VPC-MAX S-2



			 10,6 m			 14,6 m									
			 0°			 1°									
			 2°			 0°			 1°			 2°			
			kg			kg			kg			m			
13,7	82,5	61,1	50 100c	43 900c		50 100c	43 900c					13,7			
14,0	82,2	61,0	49 900c	43 700c		49 900c	43 700c					14,0			
16,0	80,3	60,6	48 200b	42 400c		48 200b	42 400c		38 000d			16,0			
18,0	78,3	60,0	46 600	41 200b	37 000c	46 600	41 200b	37 000c				18,0			
20,0	76,3	59,4	45 000	40 000	36 100b	45 000	40 000	36 100b				20,0			
22,0	74,3	58,7	43 600	39 000	35 200	43 600	39 000	35 200				22,0			
24,0	72,3	58,0	41 800	37 900	34 400	41 800	37 900	34 400				24,0			
26,0	70,2	57,1	39 400	37 000	33 600	39 400	37 000	33 600				26,0			
28,0	68,1	56,2	37 200	36 100	32 900	37 200	36 100	32 900				28,0			
30,0	65,9	55,2	35 300	35 000	32 200	35 300	35 000	32 200				30,0			
32,0	63,8	54,0	33 500	33 300	31 500	33 500	33 300	31 500				32,0			
34,0	61,5	52,8	31 900	31 800	30 900	31 900	31 800	30 900				34,0			
36,0	59,2	51,5	30 500	30 400	30 100	30 500	30 400	30 100				36,0			
38,0	56,9	50,0	29 200	29 100	28 900	29 200	29 100	28 900				38,0			
40,0	54,4	48,4	28 000	27 900	27 800	28 000	27 900	27 800				40,0			
42,0	51,9	46,7	26 900	26 800	26 700	26 900	26 800	26 700				42,0			
44,0	49,3	44,8	25 900	25 800	25 700	25 900	25 800	25 700				44,0			
46,0	46,5	42,7	25 000	24 900	24 800	25 000	24 900	24 800				46,0			
48,0	43,6	40,4	24 100	24 100	24 000	24 100	24 100	24 000				48,0			
50,0	40,5	37,8	23 400	23 300	23 200	23 400	23 300	23 200				50,0			
52,0	37,1	34,9	22 600	22 600	22 500	22 600	22 600	22 500				52,0			
54,0	33,5	31,6	22 000	21 900	21 900	22 000	21 900	21 900				54,0			
56,0	29,3	27,7	21 400	21 400	21 300	21 400	21 400	21 300				56,0			
58,0	24,3	22,9	20 900			20 900						58,0			

# MLC300 VPC-MAX S-2



148  
+  
B60

175 100 kg

360°

42,0 m





18,0 m

20°

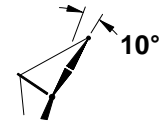
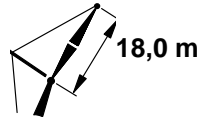
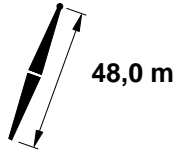
m	°	m	10,6 m			14,6 m			m			
			0°			1°				2°		
			kg	kg	kg	kg	kg	kg		kg	kg	kg
13,7											13,7	
14,0											14,0	
16,0											16,0	
18,0	80,9	59,4	37 000 <sup>b</sup>	36 200 <sup>c</sup>		37 000 <sup>b</sup>	36 200 <sup>c</sup>				18,0	
20,0	78,9	58,7	34 900	34 800 <sup>b</sup>	32 300 <sup>c</sup>	34 900	34 800 <sup>b</sup>	32 300 <sup>c</sup>			20,0	
22,0	76,9	58,0	33 100	33 000	31 700 <sup>c</sup>	33 100	33 000	31 700 <sup>c</sup>			22,0	
24,0	74,8	57,3	31 400	31 300	30 900	31 400	31 300	30 900			24,0	
26,0	72,7	56,4	29 900	29 900	29 500	29 900	29 900	29 500			26,0	
28,0	70,6	55,5	28 600	28 600	28 300	28 600	28 600	28 300			28,0	
30,0	68,4	54,4	27 400	27 300	27 100	27 400	27 300	27 100			30,0	
32,0	66,2	53,3	26 300	26 200	26 000	26 300	26 200	26 000			32,0	
34,0	63,9	52,0	25 300	25 200	25 100	25 300	25 200	25 100			34,0	
36,0	61,6	50,7	24 400	24 300	24 200	24 400	24 300	24 200			36,0	
38,0	59,2	49,2	23 500	23 500	23 400	23 500	23 500	23 400			38,0	
40,0	56,7	47,6	22 700	22 700	22 600	22 700	22 700	22 600			40,0	
42,0	54,1	45,8	22 000	22 000	21 900	22 000	22 000	21 900			42,0	
44,0	51,4	43,8	21 400	21 400	21 300	21 400	21 400	21 300			44,0	
46,0	48,6	41,7	20 800	20 700	20 700	20 800	20 700	20 700			46,0	
48,0	45,6	39,3	20 200	20 200	20 200	20 200	20 200	20 200			48,0	
50,0	42,4	36,7	19 800	19 700	19 700	19 800	19 700	19 700			50,0	
52,0	39,0	33,7	19 300	19 300	19 200	19 300	19 300	19 200			52,0	
54,0	35,1	30,2	18 900	18 900	18 900	18 900	18 900	18 900			54,0	
56,0	30,7	26,1	18 600			18 600					56,0	
58,0											58,0	

# MLC300 VPC-MAX S-2

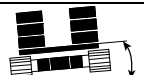
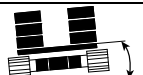
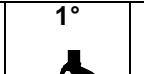
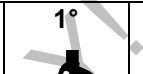

			 10,6 m			 14,6 m					
			 0°			 1°					
			 2°			 0°					
			 1°			 2°					
			kg			kg			kg		
12,2	84,5	67,4	51 700c			51 700c			12,2		
14,0	82,9	67,1	50 200c	43 800c		50 200c	43 800c		14,0		
16,0	81,2	66,7	48 600	42 600c		48 600	42 600c	38 100d	16,0		
18,0	79,4	66,2	47 100	41 500	38 100d	47 100	41 500	37 200c	18,0		
20,0	77,6	65,7	45 700	40 500	37 200c	45 700	40 500	36 400b	20,0		
22,0	75,8	65,1	44 500	39 500	36 400b	44 500	39 500	35 600	22,0		
24,0	73,9	64,4	43 300	38 600	35 600	43 300	38 600	34 900	24,0		
26,0	72,1	63,6	41 500	37 700	34 900	41 500	37 700	34 200	26,0		
28,0	70,2	62,8	39 300	36 800	34 200	39 300	36 800	33 500	28,0		
30,0	68,3	61,9	37 400	36 000	33 500	37 400	36 000	32 800	30,0		
32,0	66,4	60,9	35 600	35 300	32 800	35 600	35 300	32 200	32,0		
34,0	64,4	59,8	34 000	33 800	32 200	34 000	33 800	31 600	34,0		
36,0	62,4	58,6	32 500	32 300	31 600	32 500	32 300	31 100	36,0		
38,0	60,3	57,4	31 100	31 000	31 100	31 100	31 000	30 500	38,0		
40,0	58,2	56,0	29 900	29 800	30 500	29 900	29 800	29 600	40,0		
42,0	56,1	54,5	28 800	28 600	29 600	28 800	28 600	28 500	42,0		
44,0	53,9	52,9	27 700	27 600	28 600	27 700	27 600	27 500	44,0		
46,0	51,6	51,1	26 700	26 600	27 600	26 700	26 600	26 500	46,0		
48,0	49,2	49,2	25 900	25 800	26 600	25 900	25 800	25 700	48,0		
50,0	46,7	47,2	25 000	24 900	25 700	25 000	24 900	24 800	50,0		
52,0	44,1	44,9	24 300	24 200	24 800	24 300	24 200	24 100	52,0		
54,0	41,3	42,4	23 600	23 500	24 100	23 600	23 500	23 400	54,0		
56,0	38,4	39,7	22 900	22 800	23 400	22 900	22 800	22 700	56,0		
58,0	35,2	36,6	22 300	22 200	22 700	22 300	22 200	22 100	58,0		
60,0	31,7	33,1	21 700	21 700	22 100	21 700	21 700	21 600	60,0		
62,0	27,7	29,0	21 200	21 200	21 600	21 200	21 200	21 100	62,0		
64,0	23,0	23,9	20 800	20 800	21 100	20 800	20 800	20 700	64,0		

# MLC300 VPC-MAX S-2

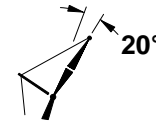
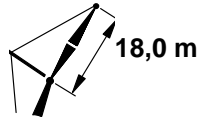
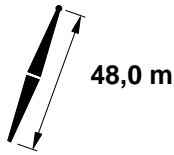

m	°	m	10,6 m			14,6 m			m			
			0°			1°				2°		
			kg	kg	kg	kg	kg	kg		kg	kg	kg
12,2											12,2	
14,0											14,0	
16,0	83,6	66,0	40 000c			40 000c					16,0	
18,0	81,8	65,5	37 800	36 400c	33 100c	37 800	36 400c	33 100c			18,0	
20,0	80,0	65,0	35 900	35 600b	32 500c	35 900	35 600b	32 500c			20,0	
22,0	78,1	64,4	34 100	34 000	32 000b	34 100	34 000	32 000b			22,0	
24,0	76,3	63,7	32 500	32 400	31 400	32 500	32 400	31 400			24,0	
26,0	74,4	62,9	31 100	31 000	30 700	31 100	31 000	30 700			26,0	
28,0	72,5	62,1	29 800	29 700	29 400	29 800	29 700	29 400			28,0	
30,0	70,6	61,1	28 600	28 500	28 300	28 600	28 500	28 300			30,0	
32,0	68,6	60,1	27 500	27 400	27 200	27 500	27 400	27 200			32,0	
34,0	66,6	59,0	26 500	26 400	26 200	26 500	26 400	26 200			34,0	
36,0	64,6	57,8	25 500	25 500	25 400	25 500	25 500	25 400			36,0	
38,0	62,5	56,5	24 700	24 600	24 500	24 700	24 600	24 500			38,0	
40,0	60,4	55,1	23 900	23 900	23 800	23 900	23 900	23 800			40,0	
42,0	58,2	53,6	23 200	23 100	23 100	23 200	23 100	23 100			42,0	
44,0	55,9	52,0	22 500	22 500	22 400	22 500	22 500	22 400			44,0	
46,0	53,6	50,2	21 900	21 800	21 800	21 900	21 800	21 800			46,0	
48,0	51,1	48,3	21 300	21 200	21 200	21 300	21 200	21 200			48,0	
50,0	48,6	46,2	20 800	20 700	20 700	20 800	20 700	20 700			50,0	
52,0	45,9	43,9	20 300	20 200	20 200	20 300	20 200	20 200			52,0	
54,0	43,1	41,3	19 800	19 800	19 800	19 800	19 800	19 800			54,0	
56,0	40,0	38,5	19 400	19 400	19 400	19 400	19 400	19 400			56,0	
58,0	36,7	35,3	19 100	19 000	19 000	19 100	19 000	19 000			58,0	
60,0	33,1	31,6	18 800	18 800	18 700	18 800	18 800	18 700			60,0	
62,0											62,0	
64,0											64,0	



# MLC300 VPC-MAX S-2

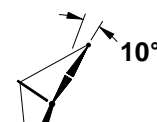
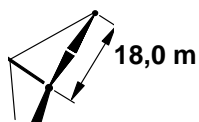
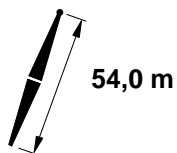

m	°	m	10,6 m			14,6 m			m			
			0°			1°				2°		
			kg	kg	kg	kg	kg	kg		kg	kg	
12,2	85,0	73,5	51 500c			51 500c			12,2			
14,0	83,5	73,2	50 300b	43 800c		50 300b	43 800c		14,0			
16,0	81,9	72,8	48 900	42 800c	38 100c	48 900	42 800c	38 100c	16,0			
18,0	80,3	72,4	47 500	41 800	37 400c	47 500	41 800	37 400c	18,0			
20,0	78,7	71,9	46 300	40 800	36 600	46 300	40 800	36 600	20,0			
22,0	77,0	71,3	45 100	39 900	35 900	45 100	39 900	35 900	22,0			
24,0	75,3	70,7	43 900	39 000	35 200	43 900	39 000	35 200	24,0			
26,0	73,7	70,0	42 800	38 200	34 600	42 800	38 200	34 600	26,0			
28,0	72,0	69,3	41 300	37 400	33 900	41 300	37 400	33 900	28,0			
30,0	70,2	68,5	39 300	36 700	33 300	39 300	36 700	33 300	30,0			
32,0	68,5	67,6	37 400	36 000	32 700	37 400	36 000	32 700	32,0			
34,0	66,7	66,6	35 800	35 200	32 200	35 800	35 200	32 200	34,0			
36,0	64,9	65,5	34 300	34 100	31 600	34 300	34 100	31 600	36,0			
38,0	63,1	64,4	32 900	32 800	31 100	32 900	32 800	31 100	38,0			
40,0	61,3	63,2	31 700	31 500	30 600	31 700	31 500	30 600	40,0			
42,0	59,4	61,9	30 500	30 400	30 000	30 500	30 400	30 000	42,0			
44,0	57,4	60,5	29 400	29 300	29 200	29 400	29 300	29 200	44,0			
46,0	55,4	59,0	28 400	28 300	28 200	28 400	28 300	28 200	46,0			
48,0	53,4	57,3	27 500	27 400	27 200	27 500	27 400	27 200	48,0			
50,0	51,3	55,6	26 600	26 500	26 400	26 600	26 500	26 400	50,0			
52,0	49,1	53,7	25 800	25 700	25 600	25 800	25 700	25 600	52,0			
54,0	46,8	51,7	25 100	25 000	24 800	25 100	25 000	24 800	54,0			
56,0	44,5	49,5	24 400	24 300	24 200	24 400	24 300	24 200	56,0			
58,0	42,0	47,1	23 700	23 600	23 500	23 700	23 600	23 500	58,0			
60,0	39,3	44,4	23 100	23 000	22 900	23 100	23 000	22 900	60,0			
62,0	36,5	41,5	22 500	22 500	22 400	22 500	22 500	22 400	62,0			
64,0	33,5	38,2	22 000	21 900	21 800	22 000	21 900	21 800	64,0			
66,0	30,1	34,5	21 500	21 500	21 400	21 500	21 500	21 400	66,0			
68,0	26,3	30,2	21 100	21 000	21 000	21 100	21 000	21 000	68,0			
70,0	21,8	24,9	20 700	20 700	20 600	20 700	20 700	20 600	70,0			

# MLC300 VPC-MAX S-2

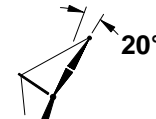
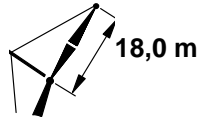
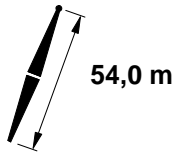
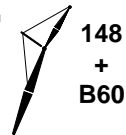

m	°	m	10,6 m			14,6 m			m
			0°			0°			
			kg	kg	kg	kg	kg	kg	
12,2									12,2
14,0									14,0
16,0	84,1	72,1	40 600c			40 600c			16,0
18,0	82,5	71,7	38 600	36 500b		38 600	36 500b		18,0
20,0	80,8	71,2	36 700	35 900	32 600c	36 700	35 900	32 600c	20,0
22,0	79,2	70,6	35 000	34 900	32 100b	35 000	34 900	32 100b	22,0
24,0	77,5	70,0	33 500	33 400	31 600	33 500	33 400	31 600	24,0
26,0	75,8	69,3	32 100	32 000	31 200	32 100	32 000	31 200	26,0
28,0	74,1	68,5	30 800	30 700	30 400	30 800	30 700	30 400	28,0
30,0	72,3	67,7	29 600	29 500	29 300	29 600	29 500	29 300	30,0
32,0	70,6	66,8	28 500	28 500	28 300	28 500	28 500	28 300	32,0
34,0	68,8	65,8	27 500	27 500	27 300	27 500	27 500	27 300	34,0
36,0	67,0	64,7	26 600	26 500	26 400	26 600	26 500	26 400	36,0
38,0	65,1	63,6	25 700	25 700	25 600	25 700	25 700	25 600	38,0
40,0	63,2	62,4	25 000	24 900	24 800	25 000	24 900	24 800	40,0
42,0	61,3	61,0	24 200	24 200	24 100	24 200	24 200	24 100	42,0
44,0	59,3	59,6	23 500	23 500	23 400	23 500	23 500	23 400	44,0
46,0	57,3	58,1	22 900	22 900	22 800	22 900	22 900	22 800	46,0
48,0	55,2	56,4	22 300	22 300	22 200	22 300	22 300	22 200	48,0
50,0	53,1	54,7	21 800	21 700	21 700	21 800	21 700	21 700	50,0
52,0	50,9	52,7	21 200	21 200	21 200	21 200	21 200	21 200	52,0
54,0	48,5	50,7	20 700	20 700	20 700	20 700	20 700	20 700	54,0
56,0	46,1	48,4	20 300	20 300	20 200	20 300	20 300	20 200	56,0
58,0	43,6	45,9	19 900	19 900	19 800	19 900	19 900	19 800	58,0
60,0	40,9	43,2	19 500	19 500	19 500	19 500	19 500	19 500	60,0
62,0	38,0	40,2	19 200	19 200	19 100	19 200	19 200	19 100	62,0
64,0	34,8	36,8	18 900	18 900	18 800	18 900	18 900	18 800	64,0
66,0	31,3	32,9	18 700	18 700	18 600	18 700	18 700	18 600	66,0
68,0									68,0
70,0									70,0

# MLC300 VPC-MAX S-2

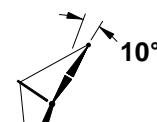
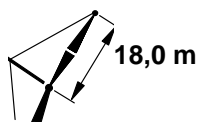
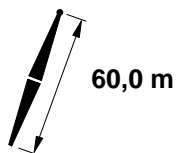

m	°	m	10,6 m			14,6 m			m
			0°			0°			
			1°			1°			
			2°			2°			
kg	kg	kg	kg	kg	kg	kg	kg		
13,7	84,2	79,3	50 400			50 400			13,7
14,0	84,0	79,3	50 200			50 200			14,0
16,0	82,5	79,0	49 000	42 700b		49 000	42 700b		16,0
18,0	81,1	78,5	47 700	41 800	37 300b	47 700	41 800	37 300b	18,0
20,0	79,5	78,1	46 600	40 900	36 600	46 600	40 900	36 600	20,0
22,0	78,0	77,6	45 500	40 100	36 000	45 500	40 100	36 000	22,0
24,0	76,5	77,0	44 400	39 300	35 400	44 400	39 300	35 400	24,0
26,0	75,0	76,4	43 500	38 500	34 800	43 500	38 500	34 800	26,0
28,0	73,4	75,7	42 500	37 800	34 200	42 500	37 800	34 200	28,0
30,0	71,9	74,9	41 000	37 100	33 600	41 000	37 100	33 600	30,0
32,0	70,3	74,1	39 200	36 500	33 100	39 200	36 500	33 100	32,0
34,0	68,7	73,2	37 500	35 800	32 600	37 500	35 800	32 600	34,0
36,0	67,0	72,3	36 000	35 200	32 100	36 000	35 200	32 100	36,0
38,0	65,4	71,3	34 600	34 400	31 600	34 600	34 400	31 600	38,0
40,0	63,7	70,2	33 300	33 200	31 100	33 300	33 200	31 100	40,0
42,0	62,0	69,0	32 100	32 000	30 700	32 100	32 000	30 700	42,0
44,0	60,3	67,8	31 000	30 900	30 200	31 000	30 900	30 200	44,0
46,0	58,5	66,4	30 000	29 800	29 700	30 000	29 800	29 700	46,0
48,0	56,7	65,0	29 000	28 900	28 800	29 000	28 900	28 800	48,0
50,0	54,9	63,4	28 100	28 000	27 900	28 100	28 000	27 900	50,0
52,0	53,0	61,8	27 300	27 200	27 100	27 300	27 200	27 100	52,0
54,0	51,0	60,1	26 500	26 400	26 300	26 500	26 400	26 300	54,0
56,0	49,0	58,2	25 800	25 700	25 600	25 800	25 700	25 600	56,0
58,0	46,9	56,2	25 100	25 000	24 900	25 100	25 000	24 900	58,0
60,0	44,8	54,0	24 400	24 400	24 200	24 400	24 400	24 200	60,0
62,0	42,5	51,6	23 800	23 700	23 600	23 800	23 700	23 600	62,0
64,0	40,1	49,1	23 300	23 200	23 100	23 300	23 200	23 100	64,0
66,0	37,6	46,3	22 700	22 600	22 600	22 700	22 600	22 600	66,0
68,0	34,9	43,2	22 200	22 200	22 100	22 200	22 200	22 100	68,0
70,0	32,0	39,8	21 800	21 700	21 600	21 800	21 700	21 600	70,0
72,0	28,8	35,9	21 400	21 300	21 100	21 400	21 300	21 200	72,0
74,0	25,2	31,4	20 900	20 700	20 400	21 000	20 900	20 900	74,0
76,0	20,8	25,8	20 000	19 700	19 400	20 700	20 600	20 500	76,0

# MLC300 VPC-MAX S-2



148  
+  
B60

175 100 kg

360°

60,0 m

18,0 m

20°

m	°	m	10,6 m			14,6 m			m
			0°	1°	2°	0°	1°	2°	
			kg	kg	kg	kg	kg	kg	
13,7									13,7
14,0									14,0
16,0									16,0
18,0	83,1	77,8	39 200			39 200			18,0
20,0	81,6	77,4	37 400		32 600b	37 400	35 900	32 600b	20,0
22,0	80,0	76,8	35 800	35 300	32 100	35 800	35 300	32 100	22,0
24,0	78,5	76,3	34 300	34 200	31 700	34 300	34 200	31 700	24,0
26,0	76,9	75,6	32 900	32 800	31 300	32 900	32 800	31 300	26,0
28,0	75,4	74,9	31 700	31 600	30 900	31 700	31 600	30 900	28,0
30,0	73,8	74,2	30 500	30 500	30 200	30 500	30 500	30 200	30,0
32,0	72,2	73,3	29 500	29 400	29 200	29 500	29 400	29 200	32,0
34,0	70,6	72,4	28 500	28 400	28 300	28 500	28 400	28 300	34,0
36,0	68,9	71,5	27 600	27 500	27 400	27 600	27 500	27 400	36,0
38,0	67,3	70,5	26 700	26 700	26 500	26 700	26 700	26 500	38,0
40,0	65,6	69,4	25 900	25 900	25 800	25 900	25 900	25 800	40,0
42,0	63,8	68,2	25 200	25 100	25 100	25 200	25 100	25 100	42,0
44,0	62,1	66,9	24 500	24 400	24 400	24 500	24 400	24 400	44,0
46,0	60,3	65,5	23 800	23 800	23 700	23 800	23 800	23 700	46,0
48,0	58,5	64,1	23 200	23 200	23 100	23 200	23 200	23 100	48,0
50,0	56,6	62,5	22 700	22 600	22 600	22 700	22 600	22 600	50,0
52,0	54,7	60,9	22 100	22 100	22 000	22 100	22 100	22 000	52,0
54,0	52,7	59,1	21 600	21 600	21 600	21 600	21 600	21 600	54,0
56,0	50,6	57,2	21 200	21 100	21 100	21 200	21 100	21 100	56,0
58,0	48,5	55,1	20 700	20 700	20 700	20 700	20 700	20 700	58,0
60,0	46,3	52,9	20 300	20 300	20 300	20 300	20 300	20 300	60,0
62,0	44,0	50,5	20 000	19 900	19 900	20 000	19 900	19 900	62,0
64,0	41,6	47,9	19 600	19 600	19 500	19 600	19 600	19 500	64,0
66,0	39,0	45,0	19 300	19 300	19 200	19 300	19 300	19 200	66,0
68,0	36,2	41,8	19 000	19 000	19 000	19 000	19 000	19 000	68,0
70,0	33,2	38,3	18 800	18 700	18 700	18 800	18 700	18 700	70,0
72,0									72,0
74,0									74,0
76,0									76,0

# MLC300 VPC-MAX S-2

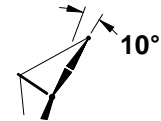
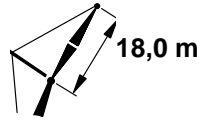
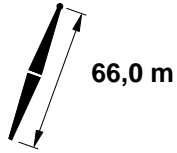
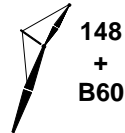

m	°	m	10,6 m			14,6 m			m			
			0°			1°				2°		
			kg	kg	kg	kg	kg	kg		kg	kg	kg
13,7	84,7	85,4	50 200			50 200				13,7		
14,0	84,5	85,3	50 000			50 000				14,0		
16,0	83,1	85,0	48 900	42 500b		48 900	42 500b			16,0		
18,0	81,7	84,6	47 800	41 700	37 100	47 800	41 700	37 100		18,0		
20,0	80,3	84,2	46 800	40 900	36 500	46 800	40 900	36 500		20,0		
22,0	78,9	83,7	45 700	40 200	36 000	45 700	40 200	36 000		22,0		
24,0	77,5	83,2	44 800	39 500	35 400	44 800	39 500	35 400		24,0		
26,0	76,1	82,6	43 800	38 800	34 900	43 800	38 800	34 900		26,0		
28,0	74,6	82,0	43 000	38 100	34 300	43 000	38 100	34 300		28,0		
30,0	73,2	81,3	42 100	37 500	33 800	42 100	37 500	33 800		30,0		
32,0	71,7	80,6	40 800	36 900	33 400	40 800	36 900	33 400		32,0		
34,0	70,3	79,7	39 100	36 300	32 900	39 100	36 300	32 900		34,0		
36,0	68,8	78,9	37 600	35 700	32 400	37 600	35 700	32 400		36,0		
38,0	67,3	77,9	36 200	35 100	32 000	36 200	35 100	32 000		38,0		
40,0	65,8	77,0	34 900	34 500	31 500	34 900	34 500	31 500		40,0		
42,0	64,2	75,9	33 700	33 400	31 100	33 700	33 400	31 100		42,0		
44,0	62,7	74,8	32 500	32 400	30 700	32 500	32 400	30 700		44,0		
46,0	61,1	73,5	31 500	31 300	30 300	31 500	31 300	30 300		46,0		
48,0	59,4	72,3	30 500	30 400	30 000	30 500	30 400	30 000		48,0		
50,0	57,8	70,9	29 600	29 500	29 300	29 600	29 500	29 300		50,0		
52,0	56,1	69,4	28 700	28 600	28 400	28 700	28 600	28 400		52,0		
54,0	54,4	67,9	27 900	27 800	27 600	27 900	27 800	27 600		54,0		
56,0	52,6	66,2	27 100	27 000	26 900	27 100	27 000	26 900		56,0		
58,0	50,8	64,5	26 400	26 300	26 200	26 400	26 300	26 200		58,0		
60,0	48,9	62,6	25 700	25 600	25 500	25 700	25 600	25 500		60,0		
62,0	47,0	60,6	25 100	25 000	24 900	25 100	25 000	24 900		62,0		
64,0	45,0	58,5	24 500	24 400	24 300	24 500	24 400	24 300		64,0		
66,0	42,9	56,2	23 900	23 900	23 700	23 900	23 900	23 700		66,0		
68,0	40,8	53,7	23 400	23 300	23 000	23 400	23 300	23 200		68,0		
70,0	38,5	51,0	22 900	22 600	21 900	22 900	22 800	22 700		70,0		
72,0	36,1	48,1	22 100	21 500	20 900	22 400	22 400	22 300		72,0		
74,0	33,5	44,8	20 900	20 400	19 800	22 000	21 900	21 800		74,0		
76,0	30,7	41,2	19 700	19 300	18 800	21 600	21 500	21 400		76,0		
78,0	27,6	37,2	18 600	18 200	17 800	21 200	21 200	21 100		78,0		
80,0	24,1	32,4	17 500	17 200	16 800	20 900	20 900	20 800		80,0		
82,0	19,9	26,6	16 400	16 200	15 900	20 600	20 600	20 500		82,0		

# MLC300 VPC-MAX S-2



148  
+  
B60

175 100 kg

360°

66,0 m

18,0 m

20°

m	°	m	10,6 m			14,6 m			m
			0°	1°	2°	0°	1°	2°	
			kg	kg	kg	kg	kg	kg	
13,7									13,7
14,0									14,0
16,0									16,0
18,0	83,6	83,9	39 700			39 700			18,0
20,0	82,2	83,5	38 000		32 500 <sup>b</sup>	38 000	35 900	32 500 <sup>b</sup>	20,0
22,0	80,8	83,0	36 400	35 400	32 100	36 400	35 400	32 100	22,0
24,0	79,3	82,5	35 000	34 800	31 700	35 000	34 800	31 700	24,0
26,0	77,9	81,9	33 700	33 600	31 300	33 700	33 600	31 300	26,0
28,0	76,5	81,2	32 500	32 400	31 000	32 500	32 400	31 000	28,0
30,0	75,0	80,5	31 400	31 300	30 700	31 400	31 300	30 700	30,0
32,0	73,5	79,8	30 300	30 200	30 100	30 300	30 200	30 100	32,0
34,0	72,1	79,0	29 400	29 300	29 100	29 400	29 300	29 100	34,0
36,0	70,6	78,1	28 500	28 400	28 300	28 500	28 400	28 300	36,0
38,0	69,0	77,1	27 600	27 500	27 400	27 600	27 500	27 400	38,0
40,0	67,5	76,1	26 800	26 800	26 700	26 800	26 800	26 700	40,0
42,0	65,9	75,1	26 100	26 000	25 900	26 100	26 000	25 900	42,0
44,0	64,4	73,9	25 400	25 300	25 300	25 400	25 300	25 300	44,0
46,0	62,7	72,7	24 700	24 700	24 600	24 700	24 700	24 600	46,0
48,0	61,1	71,4	24 100	24 100	24 000	24 100	24 100	24 000	48,0
50,0	59,4	70,0	23 500	23 500	23 400	23 500	23 500	23 400	50,0
52,0	57,7	68,5	23 000	22 900	22 900	23 000	22 900	22 900	52,0
54,0	56,0	67,0	22 500	22 400	22 400	22 500	22 400	22 400	54,0
56,0	54,2	65,3	22 000	22 000	21 900	22 000	22 000	21 900	56,0
58,0	52,3	63,5	21 500	21 500	21 500	21 500	21 500	21 500	58,0
60,0	50,4	61,6	21 100	21 100	21 100	21 100	21 100	21 100	60,0
62,0	48,5	59,6	20 700	20 700	20 700	20 700	20 700	20 700	62,0
64,0	46,4	57,4	20 300	20 300	20 300	20 300	20 300	20 300	64,0
66,0	44,3	55,0	20 000	20 000	19 900	20 000	20 000	19 900	66,0
68,0	42,1	52,5	19 700	19 600	19 600	19 700	19 600	19 600	68,0
70,0	39,8	49,7	19 400	19 300	19 300	19 400	19 300	19 300	70,0
72,0	37,3	46,7	19 100	19 100	19 100	19 100	19 100	19 100	72,0
74,0	34,6	43,4	18 900	18 800	18 800	18 900	18 800	18 800	74,0
76,0	31,7	39,6	18 700	18 600	18 600	18 700	18 600	18 600	76,0
78,0									78,0
80,0									80,0
82,0									82,0

# MLC300 VPC-MAX S-2

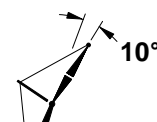
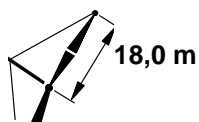
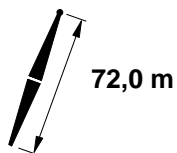
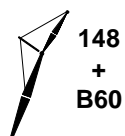

m	°	m	10,6 m			14,6 m			m			
			0°			1°				2°		
			kg	kg	kg	kg	kg	kg		kg	kg	kg
15,2	84,0	91,2	47 500			47 500				15,2		
16,0	83,6	91,1	47 100			47 100				16,0		
18,0	82,3	90,7	46 200	40 300		46 200	40 300			18,0		
20,0	81,0	90,4	45 200	39 600	35 400	45 200	39 600	35 400		20,0		
22,0	79,7	89,9	44 400	39 000	34 900	44 400	39 000	34 900		22,0		
24,0	78,3	89,4	43 500	38 400	34 400	43 500	38 400	34 400		24,0		
26,0	77,0	88,9	42 700	37 800	34 000	42 700	37 800	34 000		26,0		
28,0	75,7	88,3	42 000	37 200	33 500	42 000	37 200	33 500		28,0		
30,0	74,4	87,6	41 200	36 600	33 100	41 200	36 600	33 100		30,0		
32,0	73,0	87,0	40 500	36 100	32 700	40 500	36 100	32 700		32,0		
34,0	71,7	86,2	39 800	35 600	32 200	39 800	35 600	32 200		34,0		
36,0	70,3	85,4	39 100	35 000	31 800	39 100	35 000	31 800		36,0		
38,0	68,9	84,6	38 100	34 600	31 400	38 100	34 600	31 400		38,0		
40,0	67,5	83,6	36 700	34 100	31 000	36 700	34 100	31 000		40,0		
42,0	66,1	82,7	35 500	33 600	30 700	35 500	33 600	30 700		42,0		
44,0	64,7	81,6	34 300	33 200	30 300	34 300	33 200	30 300		44,0		
46,0	63,2	80,5	33 200	32 700	30 000	33 200	32 700	30 000		46,0		
48,0	61,7	79,4	32 200	31 900	29 600	32 200	31 900	29 600		48,0		
50,0	60,2	78,1	31 200	31 100	29 300	31 200	31 100	29 300		50,0		
52,0	58,7	76,8	30 300	30 200	29 000	30 300	30 200	29 000		52,0		
54,0	57,2	75,4	29 500	29 300	28 700	29 500	29 300	28 700		54,0		
56,0	55,6	73,9	28 700	28 500	28 200	28 700	28 500	28 200		56,0		
58,0	54,0	72,4	27 900	27 800	27 600	27 900	27 800	27 600		58,0		
60,0	52,3	70,7	27 200	27 100	26 900	27 200	27 100	27 000		60,0		
62,0	50,6	69,0	26 600	26 400	25 900	26 600	26 400	26 300		62,0		
64,0	48,9	67,1	25 900	25 500	24 500	25 900	25 800	25 700		64,0		
66,0	47,1	65,1	25 200	24 200	23 300	25 300	25 200	25 100		66,0		
68,0	45,2	63,0	23 800	23 000	22 100	24 800	24 700	24 500		68,0		
70,0	43,3	60,7	22 400	21 700	21 000	24 200	24 100	24 000		70,0		
72,0	41,3	58,3	21 100	20 500	19 800	23 700	23 600	23 500		72,0		
74,0	39,2	55,7	19 900	19 300	18 700	23 200	23 100	23 000		74,0		
76,0	37,0	52,9	18 700	18 200	17 600	22 800	22 700	22 600		76,0		
78,0	34,7	49,8	17 600	17 100	16 600	22 400	22 300	22 200		78,0		
80,0	32,2	46,4	16 500	16 100	15 700	22 000	21 900	21 800		80,0		
82,0	29,5	42,7	15 500	15 100	14 700	21 600	21 500	21 400		82,0		
84,0	26,5	38,4	14 500	14 200	13 900	21 200	21 200	21 100		84,0		

# MLC300 VPC-MAX S-2



148  
+  
B60

175 100 kg

360°

72,0 m

18,0 m

20°

m	°	m	10,6 m			14,6 m			m			
			0°			1°				2°		
			kg	kg	kg	kg	kg	kg		kg	kg	
15,2									15,2			
16,0									16,0			
18,0	84,0	90,0	40 500			40 500			18,0			
20,0	82,7	89,6	38 900	35 700	32 300 <sup>b</sup>	38 900	35 700	32 300 <sup>b</sup>	20,0			
22,0	81,4	89,1	37 400	35 300	31 900	37 400	35 300	31 900	22,0			
24,0	80,1	88,7	36 000	34 800	31 600	36 000	34 800	31 600	24,0			
26,0	78,8	88,1	34 700	34 400	31 300	34 700	34 400	31 300	26,0			
28,0	77,4	87,5	33 500	33 400	31 000	33 500	33 400	31 000	28,0			
30,0	76,1	86,9	32 400	32 300	30 600	32 400	32 300	30 600	30,0			
32,0	74,7	86,2	31 400	31 200	30 400	31 400	31 200	30 400	32,0			
34,0	73,3	85,4	30 400	30 300	30 000	30 400	30 300	30 000	34,0			
36,0	72,0	84,6	29 500	29 400	29 300	29 500	29 400	29 300	36,0			
38,0	70,6	83,7	28 600	28 600	28 500	28 600	28 600	28 500	38,0			
40,0	69,1	82,8	27 800	27 800	27 700	27 800	27 800	27 700	40,0			
42,0	67,7	81,8	27 100	27 000	26 900	27 100	27 000	26 900	42,0			
44,0	66,3	80,8	26 400	26 300	26 300	26 400	26 300	26 300	44,0			
46,0	64,8	79,7	25 700	25 700	25 600	25 700	25 700	25 600	46,0			
48,0	63,3	78,5	25 100	25 100	25 000	25 100	25 100	25 000	48,0			
50,0	61,8	77,2	24 500	24 500	24 400	24 500	24 500	24 400	50,0			
52,0	60,3	75,9	24 000	23 900	23 800	24 000	23 900	23 800	52,0			
54,0	58,7	74,5	23 400	23 400	23 300	23 400	23 400	23 300	54,0			
56,0	57,1	73,0	22 900	22 900	22 800	22 900	22 900	22 800	56,0			
58,0	55,4	71,4	22 500	22 400	22 400	22 500	22 400	22 400	58,0			
60,0	53,8	69,7	22 000	22 000	22 000	22 000	22 000	22 000	60,0			
62,0	52,1	67,9	21 600	21 600	21 500	21 600	21 600	21 500	62,0			
64,0	50,3	66,0	21 200	21 200	21 100	21 200	21 200	21 100	64,0			
66,0	48,5	64,0	20 800	20 800	20 800	20 800	20 800	20 800	66,0			
68,0	46,6	61,9	20 500	20 500	20 400	20 500	20 500	20 400	68,0			
70,0	44,6	59,6	20 200	20 100	20 100	20 200	20 100	20 100	70,0			
72,0	42,6	57,1	19 900	19 800	19 700	19 900	19 800	19 800	72,0			
74,0	40,4	54,4	19 600	19 300	19 000	19 600	19 600	19 500	74,0			
76,0	38,2	51,5	19 000	18 400	17 900	19 300	19 300	19 200	76,0			
78,0	35,8	48,4	17 800	17 400	16 900	19 100	19 100	19 000	78,0			
80,0	33,2	44,9	16 700	16 300	15 900	18 900	18 800	18 800	80,0			
82,0	30,4	41,0	15 700	15 300	14 900	18 700	18 700	18 700	82,0			
84,0									84,0			



# MLC300 VPC-MAX S-2

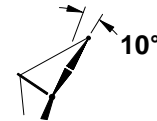
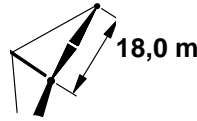
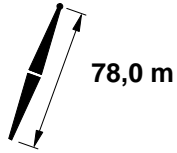

m	°	m	10,6 m			14,6 m			m
			0°			0°			
			kg	kg	kg	kg	kg	kg	
15,2	84,4	97,3	46 900			46 900			15,2
16,0	84,0	97,2	46 600			46 600			16,0
18,0	82,7	96,8	45 800	39 800		45 800	39 800		18,0
20,0	81,5	96,5	45 000	39 200	35 000	45 000	39 200	35 000	20,0
22,0	80,3	96,1	44 200	38 700	34 500	44 200	38 700	34 500	22,0
24,0	79,1	95,6	43 400	38 100	34 100	43 400	38 100	34 100	24,0
26,0	77,9	95,1	42 700	37 600	33 700	42 700	37 600	33 700	26,0
28,0	76,6	94,5	42 000	37 000	33 300	42 000	37 000	33 300	28,0
30,0	75,4	94,0	41 300	36 500	32 900	41 300	36 500	32 900	30,0
32,0	74,1	93,3	40 600	36 000	32 500	40 600	36 000	32 500	32,0
34,0	72,9	92,6	40 000	35 600	32 100	40 000	35 600	32 100	34,0
36,0	71,6	91,9	39 400	35 100	31 800	39 400	35 100	31 800	36,0
38,0	70,3	91,1	38 800	34 700	31 400	38 800	34 700	31 400	38,0
40,0	69,0	90,2	37 900	34 200	31 100	37 900	34 200	31 100	40,0
42,0	67,7	89,3	36 600	33 800	30 700	36 600	33 800	30 700	42,0
44,0	66,4	88,4	35 500	33 400	30 400	35 500	33 400	30 400	44,0
46,0	65,0	87,4	34 400	32 900	30 100	34 400	32 900	30 100	46,0
48,0	63,7	86,3	33 300	32 300	29 800	33 300	32 300	29 800	48,0
50,0	62,3	85,1	32 400	31 600	29 500	32 400	31 600	29 500	50,0
52,0	60,9	83,9	31 400	30 800	29 200	31 400	30 800	29 200	52,0
54,0	59,5	82,7	30 600	30 100	28 800	30 600	30 100	28 800	54,0
56,0	58,1	81,3	29 800	29 500	28 300	29 800	29 500	28 300	56,0
58,0	56,6	79,9	29 000	28 800	27 700	29 000	28 900	27 700	58,0
60,0	55,1	78,4	28 300	27 600	26 400	28 300	28 200	27 200	60,0
62,0	53,6	76,8	27 400	26 300	25 100	27 600	27 500	26 700	62,0
64,0	52,1	75,2	26 000	24 900	23 700	27 000	26 800	26 300	64,0
66,0	50,5	73,4	24 400	23 500	22 500	26 400	26 200	25 900	66,0
68,0	48,8	71,6	23 000	22 100	21 200	25 800	25 700	25 500	68,0
70,0	47,2	69,6	21 600	20 800	20 000	25 200	25 100	25 000	70,0
72,0	45,4	67,5	20 300	19 600	18 800	24 700	24 600	24 500	72,0
74,0	43,7	65,3	19 100	18 400	17 700	24 200	24 100	24 000	74,0
76,0	41,8	62,9	17 900	17 300	16 700	23 700	23 600	23 500	76,0
78,0	39,9	60,4	16 800	16 200	15 700	23 300	23 200	23 100	78,0
80,0	37,9	57,6	15 800	15 200	14 700	22 900	22 800	22 600	80,0
82,0	35,7	54,7	14 800	14 300	13 800	22 500	22 400	22 000	82,0
84,0	33,5	51,5	13 800	13 400	12 900	22 100	21 600	21 100	84,0
88,0	28,5	44,1	12 000	11 600	11 300	20 400	19 900	19 300	88,0
92,0	22,3	34,5	10 300			18 600			92,0

# MLC300 VPC-MAX S-2



148  
+  
B60

175 100 kg

360°

78,0 m

18,0 m

20°

m	°	m	10,6 m			14,6 m			m			
			0°			1°				2°		
			kg	kg	kg	kg	kg	kg		kg	kg	kg
15,2										15,2		
16,0										16,0		
18,0										18,0		
20,0	83,2	95,7	39 300	35 400		39 300	35 400			20,0		
22,0	82,0	95,3	37 800	35 000	30 200	37 800	35 000	30 200		22,0		
24,0	80,7	94,8	36 500	34 600	29 900	36 500	34 600	29 900		24,0		
26,0	79,5	94,3	35 200	34 200	29 700	35 200	34 200	29 700		26,0		
28,0	78,2	93,8	34 100	33 800	29 400	34 100	33 800	29 400		28,0		
30,0	77,0	93,2	33 000	32 900	29 100	33 000	32 900	29 100		30,0		
32,0	75,7	92,5	32 000	31 900	28 900	32 000	31 900	28 900		32,0		
34,0	74,4	91,8	31 000	30 900	28 700	31 000	30 900	28 700		34,0		
36,0	73,2	91,1	30 200	30 000	28 400	30 200	30 000	28 400		36,0		
38,0	71,9	90,3	29 300	29 200	28 200	29 300	29 200	28 200		38,0		
40,0	70,6	89,4	28 500	28 400	27 900	28 500	28 400	27 900		40,0		
42,0	69,2	88,5	27 800	27 700	27 500	27 800	27 700	27 500		42,0		
44,0	67,9	87,5	27 100	27 000	26 900	27 100	27 000	26 900		44,0		
46,0	66,5	86,5	26 400	26 400	26 300	26 400	26 400	26 300		46,0		
48,0	65,2	85,4	25 800	25 700	25 600	25 800	25 700	25 600		48,0		
50,0	63,8	84,3	25 200	25 100	25 100	25 200	25 100	25 100		50,0		
52,0	62,4	83,0	24 600	24 600	24 500	24 600	24 600	24 500		52,0		
54,0	61,0	81,8	24 100	24 100	24 000	24 100	24 100	24 000		54,0		
56,0	59,5	80,4	23 600	23 600	23 500	23 600	23 600	23 500		56,0		
58,0	58,0	79,0	23 200	23 100	23 000	23 200	23 100	23 000		58,0		
60,0	56,5	77,5	22 700	22 700	22 600	22 700	22 700	22 600		60,0		
62,0	55,0	75,9	22 300	22 200	22 200	22 300	22 200	22 200		62,0		
64,0	53,4	74,2	21 900	21 800	21 800	21 900	21 800	21 800		64,0		
66,0	51,8	72,4	21 500	21 400	21 400	21 500	21 400	21 400		66,0		
68,0	50,1	70,5	21 100	21 100	21 000	21 100	21 100	21 100		68,0		
70,0	48,4	68,5	20 800	20 700	20 400	20 800	20 700	20 700		70,0		
72,0	46,7	66,4	20 400	19 800	19 300	20 500	20 400	20 400		72,0		
74,0	44,9	64,1	19 500	18 800	18 100	20 200	20 100	20 100		74,0		
76,0	43,0	61,7	18 300	17 600	17 000	19 900	19 900	19 800		76,0		
78,0	41,0	59,1	17 200	16 600	16 000	19 600	19 600	19 500		78,0		
80,0	39,0	56,3	16 100	15 500	15 000	19 400	19 400	19 300		80,0		
82,0	36,8	53,3	15 000	14 500	14 100	19 200	19 100	19 100		82,0		
84,0	34,5	50,0	14 000	13 600	13 200	19 000	18 900	18 900		84,0		
88,0	29,3	42,3	12 100	11 800	11 400	18 600	18 600	18 600		88,0		
92,0										92,0		

# MLC300 VPC-MAX S-2

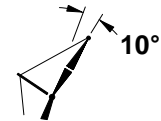
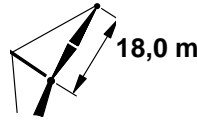
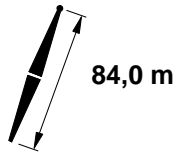

m	°	m	10,6 m			14,6 m			m			
			0°			1°				2°		
			kg	kg	kg	kg	kg	kg		kg	kg	
15,2	84,7	103,3	46 400			46 400			15,2			
16,0	84,3	103,2	46 100			46 100			16,0			
18,0	83,2	102,9	45 400	39 300		45 400	39 300		18,0			
20,0	82,0	102,6	44 600	38 800	33 900	44 600	38 800	33 900	20,0			
22,0	80,9	102,2	44 000	38 300	33 900	44 000	38 300	33 900	22,0			
24,0	79,8	101,8	43 300	37 800	33 700	43 300	37 800	33 700	24,0			
26,0	78,6	101,3	42 600	37 300	33 400	42 600	37 300	33 400	26,0			
28,0	77,4	100,8	42 000	36 900	33 000	42 000	36 900	33 000	28,0			
30,0	76,3	100,2	41 300	36 400	32 700	41 300	36 400	32 700	30,0			
32,0	75,1	99,6	40 700	35 900	32 300	40 700	35 900	32 300	32,0			
34,0	73,9	99,0	40 100	35 500	32 000	40 100	35 500	32 000	34,0			
36,0	72,7	98,3	39 600	35 100	31 700	39 600	35 100	31 700	36,0			
38,0	71,5	97,5	39 000	34 700	31 300	39 000	34 700	31 300	38,0			
40,0	70,3	96,7	38 500	34 300	31 000	38 500	34 300	31 000	40,0			
42,0	69,1	95,9	37 800	33 700	30 700	37 800	33 700	30 700	42,0			
44,0	67,9	95,0	36 700	32 900	30 400	36 700	32 900	30 400	44,0			
46,0	66,6	94,1	35 600	32 000	30 100	35 600	32 000	30 100	46,0			
48,0	65,4	93,1	34 500	31 100	29 400	34 500	31 100	29 400	48,0			
50,0	64,1	92,0	33 500	30 300	28 800	33 500	30 300	28 800	50,0			
52,0	62,8	90,9	32 600	29 500	28 100	32 600	29 500	28 100	52,0			
54,0	61,5	89,7	31 700	28 800	27 400	31 700	28 800	27 400	54,0			
56,0	60,2	88,5	30 900	28 100	26 800	30 900	28 100	26 800	56,0			
58,0	58,9	87,2	30 100	27 400	26 200	30 200	27 400	26 200	58,0			
60,0	57,5	85,9	28 300	26 600	25 300	29 400	26 800	25 600	60,0			
62,0	56,1	84,4	26 600	25 300	24 100	28 700	26 300	25 100	62,0			
64,0	54,7	82,9	24 900	23 800	22 700	28 000	25 700	24 600	64,0			
66,0	53,3	81,3	23 400	22 300	21 300	27 400	25 300	24 200	66,0			
68,0	51,8	79,7	21 900	21 000	20 000	26 800	24 800	23 800	68,0			
70,0	50,3	77,9	20 600	19 700	18 800	26 300	24 400	23 400	70,0			
72,0	48,8	76,0	19 300	18 400	17 600	25 700	24 100	23 100	72,0			
74,0	47,2	74,1	18 100	17 300	16 500	25 200	23 700	22 800	74,0			
76,0	45,6	72,0	16 900	16 200	15 500	24 700	23 400	22 500	76,0			
78,0	44,0	69,8	15 800	15 100	14 500	24 300	23 200	22 300	78,0			
80,0	42,2	67,5	14 700	14 100	13 500	23 600	22 700	21 800	80,0			
82,0	40,4	65,0	13 700	13 200	12 600	22 600	21 800	21 100	82,0			
84,0	38,6	62,3	12 800	12 300	11 800	21 600	20 900	20 200	84,0			
88,0	34,6	56,4	11 000	10 600	10 100	19 700	19 000	18 400	88,0			
92,0	30,1	49,5	9 300	9 000	8 600	17 900	17 400	16 800	92,0			
96,0	24,7	40,9	7 800	7 500	7 200	16 200	15 800	15 400	96,0			

# MLC300 VPC-MAX S-2



148  
+  
B60

175 100 kg

360°

84,0 m

18,0 m

20°

m	°	m	10,6 m			14,6 m			m			
			0°			1°				2°		
			kg	kg	kg	kg	kg	kg		kg	kg	kg
15,2										15,2		
16,0										16,0		
18,0										18,0		
20,0	83,6	101,8	39 600	35 000		39 600	35 000			20,0		
22,0	82,4	101,4	38 300	34 700	29 900	38 300	34 700	29 900		22,0		
24,0	81,3	101,0	37 000	34 400	29 700	37 000	34 400	29 700		24,0		
26,0	80,1	100,5	35 800	34 100	29 400	35 800	34 100	29 400		26,0		
28,0	79,0	100,0	34 700	33 700	29 200	34 700	33 700	29 200		28,0		
30,0	77,8	99,4	33 600	33 300	29 000	33 600	33 300	29 000		30,0		
32,0	76,6	98,8	32 600	32 500	28 800	32 600	32 500	28 800		32,0		
34,0	75,4	98,2	31 700	31 500	28 500	31 700	31 500	28 500		34,0		
36,0	74,2	97,5	30 800	30 700	28 300	30 800	30 700	28 300		36,0		
38,0	73,0	96,7	30 000	29 900	28 100	30 000	29 900	28 100		38,0		
40,0	71,8	95,9	29 200	29 100	27 900	29 200	29 100	27 900		40,0		
42,0	70,6	95,1	28 400	28 300	27 700	28 400	28 300	27 700		42,0		
44,0	69,3	94,2	27 800	27 600	27 400	27 800	27 600	27 400		44,0		
46,0	68,1	93,2	27 100	27 000	26 900	27 100	27 000	26 900		46,0		
48,0	66,8	92,2	26 500	26 400	26 300	26 500	26 400	26 300		48,0		
50,0	65,5	91,1	25 900	25 800	25 700	25 900	25 800	25 700		50,0		
52,0	64,2	90,0	25 300	25 300	25 200	25 300	25 300	25 200		52,0		
54,0	62,9	88,8	24 800	24 700	24 700	24 800	24 700	24 700		54,0		
56,0	61,6	87,6	24 300	24 200	24 200	24 300	24 200	24 200		56,0		
58,0	60,2	86,3	23 800	23 800	23 700	23 800	23 800	23 700		58,0		
60,0	58,9	84,9	23 400	23 300	23 200	23 400	23 300	23 200		60,0		
62,0	57,5	83,5	22 900	22 900	22 800	22 900	22 900	22 800		62,0		
64,0	56,0	81,9	22 500	22 500	22 400	22 500	22 500	22 400		64,0		
66,0	54,6	80,3	22 100	22 100	21 600	22 100	22 100	22 000		66,0		
68,0	53,1	78,6	21 800	21 300	20 600	21 800	21 700	21 700		68,0		
70,0	51,6	76,9	21 100	20 200	19 300	21 400	21 400	21 300		70,0		
72,0	50,0	75,0	19 800	18 900	18 100	21 100	21 000	21 000		72,0		
74,0	48,4	73,0	18 500	17 700	17 000	20 800	20 700	20 700		74,0		
76,0	46,8	70,9	17 300	16 600	15 900	20 500	20 400	20 400		76,0		
78,0	45,1	68,6	16 200	15 500	14 900	20 200	20 200	20 100		78,0		
80,0	43,3	66,3	15 100	14 500	13 900	19 900	19 900	19 800		80,0		
82,0	41,5	63,7	14 100	13 500	12 900	19 700	19 600	19 600		82,0		
84,0	39,6	61,0	13 100	12 600	12 100	19 400	19 400	19 400		84,0		
88,0	35,5	55,0	11 200	10 800	10 400	19 000	19 000	18 500		88,0		
92,0	30,9	47,8	9 500			18 000				92,0		
96,0										96,0		

# MLC300 VPC-MAX S-2

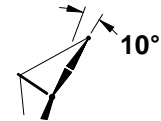
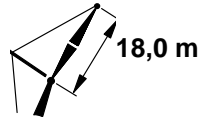
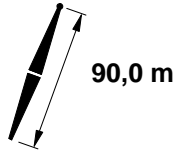
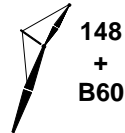

m	°	m	10,6 m			14,6 m			m			
			0°			1°				2°		
			kg	kg	kg	kg	kg	kg		kg	kg	kg
16,8	84,2	109,2	44 900			44 900			16,8			
18,0	83,6	109,0	44 500			44 500			18,0			
20,0	82,5	108,7	43 900	38 000	28 600	43 900	38 000	28 600	20,0			
22,0	81,4	108,3	43 300	37 600	28 600	43 300	37 600	28 600	22,0			
24,0	80,3	107,9	42 700	37 200	28 600	42 700	37 200	28 600	24,0			
26,0	79,2	107,5	42 100	36 700	28 600	42 100	36 700	28 600	26,0			
28,0	78,2	107,0	41 500	36 300	28 600	41 500	36 300	28 600	28,0			
30,0	77,1	106,4	41 000	35 900	28 600	41 000	35 900	28 600	30,0			
32,0	76,0	105,9	40 500	35 500	28 600	40 500	35 500	28 600	32,0			
34,0	74,8	105,3	39 900	35 100	28 600	39 900	35 100	28 600	34,0			
36,0	73,7	104,6	39 400	34 400	28 600	39 400	34 400	28 600	36,0			
38,0	72,6	103,9	38 300	33 300	28 600	38 300	33 300	28 600	38,0			
40,0	71,5	103,2	37 100	32 200	28 600	37 100	32 200	28 600	40,0			
42,0	70,3	102,4	35 900	31 300	28 600	35 900	31 300	28 600	42,0			
44,0	69,2	101,6	34 800	30 300	28 300	34 800	30 300	28 300	44,0			
46,0	68,0	100,7	33 700	29 500	27 900	33 700	29 500	27 900	46,0			
48,0	66,9	99,8	32 700	28 600	27 100	32 700	28 600	27 100	48,0			
50,0	65,7	98,8	31 800	27 800	26 400	31 800	27 800	26 400	50,0			
52,0	64,5	97,8	30 900	27 100	25 800	30 900	27 100	25 800	52,0			
54,0	63,3	96,7	30 100	26 400	25 100	30 100	26 400	25 100	54,0			
56,0	62,1	95,5	29 300	25 700	24 500	29 300	25 700	24 500	56,0			
58,0	60,8	94,3	28 500	25 100	23 900	28 500	25 100	23 900	58,0			
60,0	59,6	93,1	27 700	24 500	23 400	27 800	24 500	23 400	60,0			
62,0	58,3	91,8	26 200	23 900	22 800	27 200	23 900	22 800	62,0			
64,0	57,0	90,4	24 600	23 300	22 100	26 600	23 400	22 300	64,0			
66,0	55,7	88,9	23 000	21 900	20 800	26 000	22 900	21 900	66,0			
68,0	54,4	87,4	21 600	20 500	19 500	25 400	22 400	21 500	68,0			
70,0	53,0	85,8	20 200	19 200	18 300	24 900	22 000	21 000	70,0			
72,0	51,6	84,1	18 900	18 000	17 100	24 500	21 600	20 700	72,0			
74,0	50,2	82,4	17 700	16 900	16 000	24 000	21 200	20 300	74,0			
76,0	48,8	80,5	16 600	15 700	15 000	23 600	20 800	20 000	76,0			
78,0	47,3	78,6	15 500	14 700	14 000	23 200	20 500	19 700	78,0			
80,0	45,8	76,5	14 400	13 700	13 100	22 900	20 200	19 400	80,0			
82,0	44,2	74,3	13 400	12 800	12 100	22 300	19 900	19 200	82,0			
84,0	42,6	72,0	12 500	11 900	11 300	21 400	19 700	19 000	84,0			
88,0	39,2	67,0	10 700	10 200	9 700	19 400	18 700	18 000	88,0			
92,0	35,5	61,3	9 100	8 600	8 200	17 700	17 100	16 500	92,0			
96,0	31,4	54,7	7 500	7 200	6 800	16 000	15 500	15 000	96,0			
100,0	26,7	46,7	6 100	5 800	5 500	14 500	14 100	13 600	100,0			
104,0	20,9	36,5	4 800			13 100			104,0			

# MLC300 VPC-MAX S-2



148  
+  
B60

175 100 kg

360°

90,0 m

18,0 m

20°

m	°	m	10,6 m			14,6 m			m			
			0°			1°				2°		
			kg	kg	kg	kg	kg	kg		kg	kg	kg
16,8										16,8		
18,0										18,0		
20,0	84,0	107,9	39 200			39 200				20,0		
22,0	82,9	107,5	38 500	34 200		38 500	34 200			22,0		
24,0	81,8	107,1	37 300	33 900	26 200	37 300	33 900	26 200		24,0		
26,0	80,7	106,7	36 100	33 600	26 200	36 100	33 600	26 200		26,0		
28,0	79,6	106,2	35 000	33 300	26 200	35 000	33 300	26 200		28,0		
30,0	78,5	105,6	34 000	33 100	26 200	34 000	33 100	26 200		30,0		
32,0	77,4	105,1	33 000	32 500	26 200	33 000	32 500	26 200		32,0		
34,0	76,3	104,5	32 100	31 600	26 200	32 100	31 600	26 200		34,0		
36,0	75,1	103,8	31 300	30 700	26 200	31 300	30 700	26 200		36,0		
38,0	74,0	103,1	30 500	29 900	26 200	30 500	29 900	26 200		38,0		
40,0	72,9	102,4	29 700	29 100	26 200	29 700	29 100	26 200		40,0		
42,0	71,7	101,6	29 000	28 300	26 200	29 000	28 300	26 200		42,0		
44,0	70,6	100,7	28 300	27 500	25 900	28 300	27 500	25 900		44,0		
46,0	69,4	99,8	27 700	26 800	25 500	27 700	26 800	25 500		46,0		
48,0	68,2	98,9	27 100	26 100	24 900	27 100	26 100	24 900		48,0		
50,0	67,0	97,9	26 500	25 500	24 300	26 500	25 500	24 300		50,0		
52,0	65,8	96,9	25 900	24 900	23 800	25 900	24 900	23 800		52,0		
54,0	64,6	95,8	25 400	24 300	23 200	25 400	24 300	23 200		54,0		
56,0	63,4	94,6	24 900	23 800	22 700	24 900	23 800	22 700		56,0		
58,0	62,1	93,4	24 400	23 300	22 200	24 400	23 300	22 200		58,0		
60,0	60,9	92,2	24 000	22 800	21 800	24 000	22 800	21 800		60,0		
62,0	59,6	90,8	23 500	22 300	21 400	23 500	22 300	21 400		62,0		
64,0	58,3	89,4	23 100	21 900	21 000	23 100	21 900	21 000		64,0		
66,0	56,9	88,0	22 700	21 500	20 600	22 700	21 500	20 600		66,0		
68,0	55,6	86,4	22 100	20 800	19 900	22 300	21 100	20 200		68,0		
70,0	54,2	84,8	20 800	19 800	18 800	22 000	20 700	19 900		70,0		
72,0	52,8	83,1	19 500	18 500	17 600	21 600	20 400	19 600		72,0		
74,0	51,4	81,3	18 200	17 400	16 500	21 300	20 100	19 300		74,0		
76,0	49,9	79,4	17 000	16 200	15 400	21 000	19 800	19 000		76,0		
78,0	48,4	77,5	15 900	15 200	14 400	20 700	19 500	18 800		78,0		
80,0	46,9	75,4	14 800	14 100	13 500	20 400	19 300	18 600		80,0		
82,0	45,3	73,2	13 800	13 100	12 500	20 200	19 100	18 400		82,0		
84,0	43,6	70,8	12 800	12 200	11 600	19 900	18 900	18 200		84,0		
88,0	40,2	65,7	11 000	10 500	10 000	19 500	18 600	17 900		88,0		
92,0	36,4	59,9	9 300	8 800	8 400	17 900	17 200	16 600		92,0		
96,0	32,2	53,1	7 700	7 300	7 000	16 200	15 700	15 100		96,0		
100,0										100,0		
104,0										104,0		

# MLC300 VPC-MAX S-2

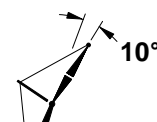
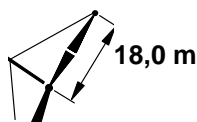
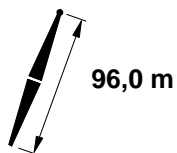

m	°	m	10,6 m			14,6 m			m			
			0°			1°				2°		
			kg	kg	kg	kg	kg	kg		kg	kg	
16,8	84,5	115,2	44 100			44 100			16,8			
18,0	83,9	115,1	43 800			43 800			18,0			
20,0	82,9	114,8	43 300	32 500	24 100	43 300	32 500	24 100	20,0			
22,0	81,9	114,4	42 800	32 500	24 100	42 800	32 500	24 100	22,0			
24,0	80,8	114,0	42 300	32 500	24 100	42 300	32 500	24 100	24,0			
26,0	79,8	113,6	41 700	32 500	24 100	41 700	32 500	24 100	26,0			
28,0	78,8	113,1	41 200	32 500	24 100	41 200	32 500	24 100	28,0			
30,0	77,8	112,7	40 700	32 500	24 100	40 700	32 500	24 100	30,0			
32,0	76,7	112,1	40 200	32 500	24 100	40 200	32 500	24 100	32,0			
34,0	75,7	111,5	39 800	32 500	24 100	39 800	32 500	24 100	34,0			
36,0	74,6	110,9	39 300	32 500	24 100	39 300	32 500	24 100	36,0			
38,0	73,6	110,3	38 800	32 500	24 100	38 800	32 500	24 100	38,0			
40,0	72,5	109,6	38 400	32 300	24 100	38 400	32 300	24 100	40,0			
42,0	71,4	108,8	38 000	32 000	24 100	38 000	32 000	24 100	42,0			
44,0	70,3	108,1	37 500	31 700	24 100	37 500	31 700	24 100	44,0			
46,0	69,3	107,2	36 600	31 400	24 100	36 600	31 400	24 100	46,0			
48,0	68,2	106,4	35 600	30 800	24 100	35 600	30 800	24 100	48,0			
50,0	67,1	105,5	34 700	30 100	24 100	34 700	30 100	24 100	50,0			
52,0	65,9	104,5	33 700	29 400	24 100	33 700	29 400	24 100	52,0			
54,0	64,8	103,5	32 700	28 700	24 100	32 900	28 700	24 100	54,0			
56,0	63,7	102,4	30 800	27 900	24 100	32 100	28 000	24 100	56,0			
58,0	62,5	101,3	28 800	27 100	24 100	31 300	27 300	24 100	58,0			
60,0	61,4	100,1	26 900	25 400	23 400	30 600	26 800	24 100	60,0			
62,0	60,2	98,9	25 200	23 800	22 400	29 900	26 200	24 100	62,0			
64,0	59,0	97,6	23 500	22 200	20 900	29 300	25 600	24 100	64,0			
66,0	57,8	96,3	22 000	20 800	19 600	28 600	25 100	23 800	66,0			
68,0	56,6	94,9	20 600	19 400	18 300	28 100	24 600	23 500	68,0			
70,0	55,3	93,4	19 200	18 100	17 100	27 500	24 100	23 100	70,0			
72,0	54,1	91,9	17 900	16 900	15 900	27 000	23 700	22 700	72,0			
74,0	52,8	90,3	16 700	15 700	14 900	26 300	23 300	22 300	74,0			
76,0	51,5	88,6	15 500	14 600	13 800	25 100	22 900	21 900	76,0			
78,0	50,1	86,8	14 400	13 600	12 800	23 900	22 500	21 500	78,0			
80,0	48,7	85,0	13 400	12 600	11 900	22 700	21 700	20 800	80,0			
82,0	47,3	83,0	12 400	11 700	11 000	21 700	20 700	19 800	82,0			
84,0	45,9	81,0	11 400	10 800	10 100	20 600	19 700	18 900	84,0			
88,0	42,9	76,6	9 700	9 100	8 500	18 700	17 900	17 200	88,0			
92,0	39,7	71,7	8 000	7 500	7 000	16 900	16 200	15 600	92,0			
96,0	36,3	66,1	6 500	6 100	5 700	15 300	14 700	14 100	96,0			
100,0	32,5	59,8	5 100	4 800	4 400	13 800	13 300	12 800	100,0			
104,0	28,3	52,3	3 800			12 400	12 000	11 500	104,0			
108,0	23,3	43,1				11 100	10 700	10 400	108,0			

# MLC300 VPC-MAX S-2



148  
+  
B60

175 100 kg

360°

96,0 m

18,0 m

20°

m	°	m	10,6 m			14,6 m			m			
			0°			1°				2°		
			kg	kg	kg	kg	kg	kg		kg	kg	
16,8									16,8			
18,0									18,0			
20,0	84,3	114,0	38 700			38 700			20,0			
22,0	83,3	113,6	38 400	30 100		38 400	30 100		22,0			
24,0	82,2	113,2	37 600	30 100	22 200	37 600	30 100	22 200	24,0			
26,0	81,2	112,8	36 600	30 100	22 200	36 600	30 100	22 200	26,0			
28,0	80,2	112,3	35 600	30 100	22 200	35 600	30 100	22 200	28,0			
30,0	79,1	111,8	34 600	30 100	22 200	34 600	30 100	22 200	30,0			
32,0	78,1	111,3	33 600	30 100	22 200	33 600	30 100	22 200	32,0			
34,0	77,0	110,7	32 800	30 100	22 200	32 800	30 100	22 200	34,0			
36,0	76,0	110,1	31 900	30 100	22 200	31 900	30 100	22 200	36,0			
38,0	74,9	109,4	31 100	30 100	22 200	31 100	30 100	22 200	38,0			
40,0	73,8	108,7	30 400	30 000	22 200	30 400	30 000	22 200	40,0			
42,0	72,7	108,0	29 700	29 500	22 200	29 700	29 500	22 200	42,0			
44,0	71,6	107,2	29 000	28 900	22 200	29 000	28 900	22 200	44,0			
46,0	70,6	106,4	28 400	28 200	22 200	28 400	28 200	22 200	46,0			
48,0	69,4	105,5	27 700	27 600	22 200	27 700	27 600	22 200	48,0			
50,0	68,3	104,6	27 100	27 100	22 200	27 100	27 100	22 200	50,0			
52,0	67,2	103,6	26 600	26 500	22 200	26 600	26 500	22 200	52,0			
54,0	66,1	102,6	26 100	26 000	22 200	26 100	26 000	22 200	54,0			
56,0	64,9	101,5	25 600	25 500	22 200	25 600	25 500	22 200	56,0			
58,0	63,8	100,4	25 100	25 000	22 200	25 100	25 000	22 200	58,0			
60,0	62,6	99,2	24 600	24 600	22 200	24 600	24 600	22 200	60,0			
62,0	61,4	98,0	24 200	23 900	22 000	24 200	24 100	22 200	62,0			
64,0	60,2	96,7	23 800	22 900	21 600	23 800	23 700	22 200	64,0			
66,0	59,0	95,3	22 700	21 500	20 300	23 400	23 300	22 200	66,0			
68,0	57,7	93,9	21 200	20 100	18 900	23 000	22 900	22 000	68,0			
70,0	56,5	92,4	19 800	18 700	17 700	22 600	22 500	21 700	70,0			
72,0	55,2	90,9	18 500	17 500	16 500	22 300	22 200	21 300	72,0			
74,0	53,9	89,3	17 300	16 300	15 400	21 900	21 900	21 000	74,0			
76,0	52,6	87,6	16 100	15 200	14 300	21 600	21 600	20 700	76,0			
78,0	51,2	85,8	14 900	14 100	13 300	21 300	21 300	20 500	78,0			
80,0	49,8	83,9	13 900	13 100	12 300	21 000	21 000	20 200	80,0			
82,0	48,4	81,9	12 800	12 100	11 400	20 700	20 700	20 000	82,0			
84,0	47,0	79,9	11 900	11 200	10 500	20 500	20 000	19 200	84,0			
88,0	43,9	75,4	10 000	9 400	8 900	19 000	18 200	17 400	88,0			
92,0	40,7	70,4	8 300	7 800	7 300	17 200	16 500	15 800	92,0			
96,0	37,2	64,7	6 800	6 300	5 900	15 500	14 900	14 300	96,0			
100,0	33,3	58,2	5 300	5 000	4 600	14 000	13 400	12 900	100,0			
104,0									104,0			
108,0									108,0			



# MLC300 VPC-MAX S-2

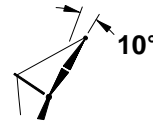
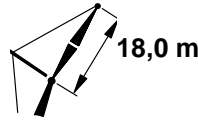
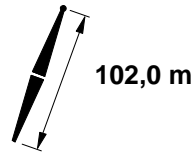

m	°	m	10,6 m		14,6 m		m
			0°		1°		
			kg	kg	kg	kg	
16,8	84,8	121,3	42 800		42 800		16,8
18,0	84,2	121,1	42 500		42 500		18,0
20,0	83,2	120,8	42 100	26 900	42 100	26 900	20,0
22,0	82,3	120,5	41 600	26 900	41 600	26 900	22,0
24,0	81,3	120,1	41 200	26 900	41 200	26 900	24,0
26,0	80,3	119,7	40 700	26 900	40 700	26 900	26,0
28,0	79,4	119,3	40 100	26 900	40 100	26 900	28,0
30,0	78,4	118,8	38 900	26 900	38 900	26 900	30,0
32,0	77,4	118,3	37 600	26 900	37 600	26 900	32,0
34,0	76,4	117,8	36 400	26 900	36 400	26 900	34,0
36,0	75,4	117,2	35 200	26 900	35 200	26 900	36,0
38,0	74,4	116,6	34 000	26 900	34 000	26 900	38,0
40,0	73,4	115,9	32 900	26 900	32 900	26 900	40,0
42,0	72,4	115,2	31 900	26 900	31 900	26 900	42,0
44,0	71,4	114,5	30 900	26 600	30 900	26 600	44,0
46,0	70,4	113,7	30 000	26 100	30 000	26 100	46,0
48,0	69,3	112,9	29 100	25 300	29 100	25 300	48,0
50,0	68,3	112,0	28 200	24 600	28 200	24 600	50,0
52,0	67,2	111,1	27 400	23 900	27 400	23 900	52,0
54,0	66,2	110,2	26 700	23 300	26 700	23 300	54,0
56,0	65,1	109,2	25 900	22 700	25 900	22 700	56,0
58,0	64,0	108,1	25 200	22 100	25 200	22 100	58,0
60,0	63,0	107,0	24 600	21 500	24 600	21 500	60,0
62,0	61,9	105,9	24 000	21 000	24 000	21 000	62,0
64,0	60,7	104,7	23 100	20 400	23 400	20 400	64,0
66,0	59,6	103,5	21 500	19 800	22 800	20 000	66,0
68,0	58,5	102,1	20 100	18 900	22 300	19 500	68,0
70,0	57,3	100,8	18 700	17 600	21 700	19 100	70,0
72,0	56,2	99,4	17 500	16 400	21 200	18 600	72,0
74,0	55,0	97,9	16 200	15 200	20 800	18 200	74,0
76,0	53,8	96,3	15 100	14 100	20 400	17 900	76,0
78,0	52,5	94,7	14 000	13 100	19 900	17 500	78,0
80,0	51,3	93,0	12 900	12 100	19 500	17 100	80,0
82,0	50,0	91,3	11 900	11 200	19 200	16 800	82,0
84,0	48,7	89,4	11 000	10 300	18 800	16 500	84,0
88,0	46,0	85,5	9 200	8 600	18 100	15 900	88,0
92,0	43,2	81,1	7 600	7 100	16 600	15 400	92,0
96,0	40,2	76,3	6 100	5 600	15 000	14 400	96,0
100,0	37,0	70,8	4 700	4 300	13 500	12 900	100,0
104,0	33,5	64,7	3 500		12 100	11 600	104,0
108,0	29,6	57,6			10 900	10 400	108,0
112,0	25,1	49,2			9 700	9 300	112,0

# MLC300 VPC-MAX S-2

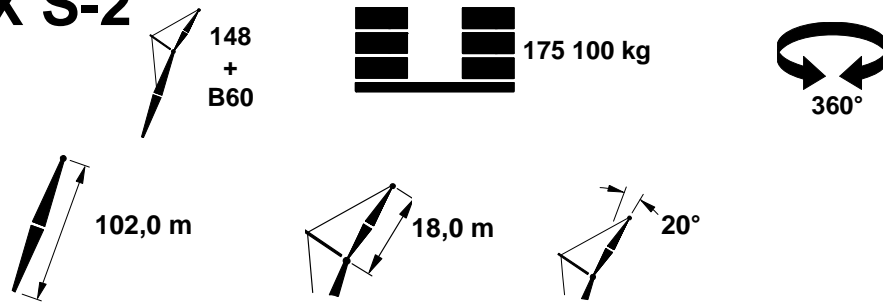

m	°	m	10,6 m		14,6 m		m
			0°		1°		
			kg	kg	kg	kg	
16,8							16,8
18,0							18,0
20,0	84,6	120,0	37 900		37 900		20,0
22,0	83,6	119,7	37 600	25 100	37 600	25 100	22,0
24,0	82,6	119,3	37 100	25 100	37 100	25 100	24,0
26,0	81,6	118,9	36 100	25 100	36 100	25 100	26,0
28,0	80,7	118,5	35 100	25 100	35 100	25 100	28,0
30,0	79,7	118,0	34 000	25 100	34 000	25 100	30,0
32,0	78,7	117,5	33 000	25 100	33 000	25 100	32,0
34,0	77,7	116,9	32 100	25 100	32 100	25 100	34,0
36,0	76,7	116,3	31 200	25 100	31 200	25 100	36,0
38,0	75,7	115,7	30 300	25 100	30 300	25 100	38,0
40,0	74,7	115,1	29 400	25 000	29 400	25 000	40,0
42,0	73,6	114,4	28 600	24 800	28 600	24 800	42,0
44,0	72,6	113,6	27 900	24 300	27 900	24 300	44,0
46,0	71,6	112,8	27 100	23 700	27 100	23 700	46,0
48,0	70,5	112,0	26 400	23 100	26 400	23 100	48,0
50,0	69,5	111,1	25 700	22 500	25 700	22 500	50,0
52,0	68,4	110,2	25 100	22 000	25 100	22 000	52,0
54,0	67,4	109,3	24 500	21 400	24 500	21 400	54,0
56,0	66,3	108,3	23 800	20 900	23 800	20 900	56,0
58,0	65,2	107,2	23 300	20 400	23 300	20 400	58,0
60,0	64,1	106,1	22 800	20 000	22 800	20 000	60,0
62,0	63,0	105,0	22 200	19 500	22 200	19 500	62,0
64,0	61,9	103,8	21 700	19 100	21 700	19 100	64,0
66,0	60,8	102,5	21 200	18 700	21 200	18 700	66,0
68,0	59,6	101,2	20 600	18 300	20 800	18 300	68,0
70,0	58,4	99,8	19 400	17 900	20 400	17 900	70,0
72,0	57,3	98,4	18 100	16 900	20 000	17 500	72,0
74,0	56,1	96,9	16 900	15 800	19 600	17 200	74,0
76,0	54,8	95,3	15 700	14 700	19 200	16 900	76,0
78,0	53,6	93,7	14 500	13 600	18 900	16 600	78,0
80,0	52,3	92,0	13 500	12 600	18 500	16 300	80,0
82,0	51,0	90,2	12 400	11 600	18 200	16 000	82,0
84,0	49,7	88,3	11 500	10 700	17 900	15 700	84,0
88,0	47,0	84,3	9 600	9 000	17 300	15 200	88,0
92,0	44,1	79,9	8 000	7 400	16 800	14 800	92,0
96,0	41,1	75,0	6 400	5 900	15 200	14 300	96,0
100,0	37,8	69,5	5 000	4 600	13 700	13 100	100,0
104,0	34,3	63,2	3 700		12 300	11 800	104,0
108,0	30,3	55,9			11 000	10 500	108,0
112,0							112,0

# MLC300 VPC-MAX S-2

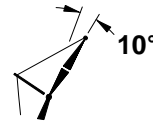
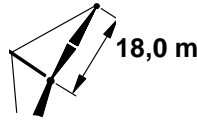
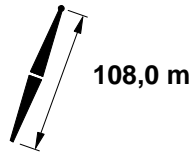

			10,6 m		14,6 m			
			0°		1°			
m	°	m	kg	kg	kg	kg	m	
18,3	84,4	127,1	38 300		38 300		18,3	
20,0	83,6	126,9	38 300	22 800	38 300	22 800	20,0	
22,0	82,7	126,6	38 300	22 800	38 300	22 800	22,0	
24,0	81,7	126,2	38 300	22 800	38 300	22 800	24,0	
26,0	80,8	125,8	38 300	22 800	38 300	22 800	26,0	
28,0	79,9	125,4	38 200	22 800	38 200	22 800	28,0	
30,0	78,9	125,0	37 500	22 800	37 500	22 800	30,0	
32,0	78,0	124,5	36 200	22 800	36 200	22 800	32,0	
34,0	77,1	124,0	35 000	22 800	35 000	22 800	34,0	
36,0	76,1	123,4	33 800	22 800	33 800	22 800	36,0	
38,0	75,2	122,8	32 600	22 800	32 600	22 800	38,0	
40,0	74,2	122,2	31 500	22 800	31 500	22 800	40,0	
42,0	73,3	121,6	30 400	22 800	30 400	22 800	42,0	
44,0	72,3	120,9	29 400	22 800	29 400	22 800	44,0	
46,0	71,3	120,1	28 400	22 800	28 400	22 800	46,0	
48,0	70,4	119,4	27 500	22 800	27 500	22 800	48,0	
50,0	69,4	118,5	26 600	22 500	26 600	22 500	50,0	
52,0	68,4	117,7	25 800	21 900	25 800	21 900	52,0	
54,0	67,4	116,8	25 000	21 300	25 000	21 300	54,0	
56,0	66,4	115,9	24 300	20 700	24 300	20 700	56,0	
58,0	65,4	114,9	23 500	20 000	23 500	20 000	58,0	
60,0	64,4	113,9	22 800	19 500	22 800	19 500	60,0	
62,0	63,3	112,8	22 200	18 900	22 200	18 900	62,0	
64,0	62,3	111,7	21 600	18 400	21 600	18 400	64,0	
66,0	61,2	110,5	20 500	17 900	21 000	17 900	66,0	
68,0	60,2	109,3	19 100	17 300	20 400	17 400	68,0	
70,0	59,1	108,0	17 700	16 500	19 900	17 000	70,0	
72,0	58,0	106,7	16 400	15 300	19 400	16 600	72,0	
74,0	56,9	105,3	15 200	14 100	18 900	16 200	74,0	
76,0	55,8	103,9	14 100	13 000	18 500	15 800	76,0	
78,0	54,6	102,4	13 000	12 000	18 000	15 400	78,0	
80,0	53,5	100,8	11 900	11 000	17 600	15 100	80,0	
82,0	52,3	99,2	10 900	10 100	17 200	14 700	82,0	
84,0	51,1	97,5	10 000	9 200	16 900	14 400	84,0	
88,0	48,7	93,9	8 200	7 500	16 200	13 800	88,0	
92,0	46,1	90,0	6 600	6 000	15 600	13 300	92,0	
96,0	43,5	85,6	5 100	4 600	14 300	12 900	96,0	
100,0	40,6	80,9	3 800	3 300	12 800	12 100	100,0	
104,0	37,6	75,6			11 400	10 900	104,0	
108,0	34,4	69,7			10 200	9 600	108,0	
112,0	30,8	62,9			9 000	8 500	112,0	
116,0	26,8	55,0			7 800	7 500	116,0	
120,0	22,0	45,2			6 800	6 500	120,0	



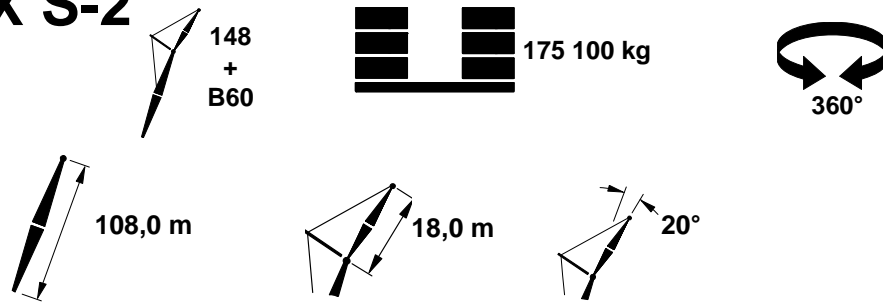

# MLC300 VPC-MAX S-2

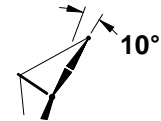
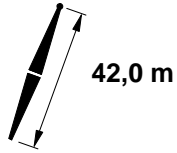
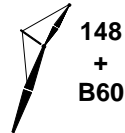

m	°	m	10,6 m		14,6 m		m
			0°		1°		
			kg	kg	kg	kg	
18,3							18,3
20,0	84,8	126,1	36 200		36 200		20,0
22,0	83,9	125,8	36 200		36 200		22,0
24,0	83,0	125,4	36 200	21 300	36 200	21 300	24,0
26,0	82,0	125,0	35 700	21 300	35 700	21 300	26,0
28,0	81,1	124,6	34 600	21 300	34 600	21 300	28,0
30,0	80,2	124,2	33 600	21 300	33 600	21 300	30,0
32,0	79,2	123,7	32 500	21 300	32 500	21 300	32,0
34,0	78,3	123,2	31 500	21 300	31 500	21 300	34,0
36,0	77,3	122,6	30 600	21 300	30 600	21 300	36,0
38,0	76,4	122,0	29 600	21 300	29 600	21 300	38,0
40,0	75,4	121,4	28 700	21 300	28 700	21 300	40,0
42,0	74,5	120,7	27 800	21 300	27 800	21 300	42,0
44,0	73,5	120,0	27 000	21 300	27 000	21 300	44,0
46,0	72,5	119,3	26 200	21 300	26 200	21 300	46,0
48,0	71,5	118,5	25 400	21 300	25 400	21 300	48,0
50,0	70,5	117,7	24 700	21 000	24 700	21 000	50,0
52,0	69,6	116,8	24 000	20 500	24 000	20 500	52,0
54,0	68,5	115,9	23 300	19 900	23 300	19 900	54,0
56,0	67,5	115,0	22 700	19 400	22 700	19 400	56,0
58,0	66,5	114,0	22 000	18 800	22 000	18 800	58,0
60,0	65,5	112,9	21 500	18 300	21 500	18 300	60,0
62,0	64,4	111,9	20 900	17 800	20 900	17 800	62,0
64,0	63,4	110,7	20 300	17 400	20 300	17 400	64,0
66,0	62,3	109,6	19 800	17 000	19 800	17 000	66,0
68,0	61,3	108,3	19 300	16 500	19 300	16 500	68,0
70,0	60,2	107,1	18 400	16 200	18 900	16 200	70,0
72,0	59,1	105,7	17 100	15 600	18 400	15 800	72,0
74,0	58,0	104,3	15 900	14 800	18 000	15 400	74,0
76,0	56,8	102,9	14 700	13 700	17 600	15 000	76,0
78,0	55,7	101,4	13 600	12 600	17 200	14 700	78,0
80,0	54,5	99,8	12 500	11 600	16 900	14 400	80,0
82,0	53,3	98,2	11 500	10 600	16 500	14 100	82,0
84,0	52,1	96,4	10 500	9 700	16 200	13 900	84,0
88,0	49,7	92,8	8 700	8 000	15 600	13 300	88,0
92,0	47,1	88,8	7 000	6 400	15 100	12 900	92,0
96,0	44,4	84,4	5 500	4 900	14 600	12 500	96,0
100,0	41,5	79,6	4 100	3 600	13 000	12 200	100,0
104,0	38,4	74,2			11 600	11 100	104,0
108,0	35,1	68,2			10 300	9 800	108,0
112,0	31,4	61,2			9 100	8 600	112,0
116,0							116,0
120,0							120,0

# MLC300 VPC-MAX S-2



			 10,6 m			 14,6 m					
			 0°			 1°			 2°		
			kg	kg	kg	kg	kg	kg			
16,8	81,4	66,5	36 200 <sup>b</sup>	31 000 <sup>c</sup>		36 200 <sup>b</sup>	31 000 <sup>c</sup>		16,8		
18,0	80,3	66,2	35 500	30 500 <sup>c</sup>		35 500	30 500 <sup>c</sup>		18,0		
20,0	78,5	65,6	34 400	29 700 <sup>b</sup>	26 200 <sup>c</sup>	34 400	29 700 <sup>b</sup>	26 200 <sup>c</sup>	20,0		
22,0	76,7	65,0	33 300	28 900	25 600 <sup>b</sup>	33 300	28 900	25 600 <sup>b</sup>	22,0		
24,0	74,8	64,3	32 400	28 200	25 100	32 400	28 200	25 100	24,0		
26,0	73,0	63,6	31 400	27 500	24 500	31 400	27 500	24 500	26,0		
28,0	71,1	62,8	30 300	26 800	24 000	30 300	26 800	24 000	28,0		
30,0	69,2	61,8	28 700	26 200	23 500	28 700	26 200	23 500	30,0		
32,0	67,3	60,8	27 200	25 600	23 000	27 200	25 600	23 000	32,0		
34,0	65,3	59,8	25 800	25 000	22 500	25 800	25 000	22 500	34,0		
36,0	63,3	58,6	24 600	24 300	22 100	24 600	24 300	22 100	36,0		
38,0	61,2	57,3	23 500	23 300	21 700	23 500	23 300	21 700	38,0		
40,0	59,1	55,9	22 500	22 300	21 300	22 500	22 300	21 300	40,0		
42,0	56,9	54,4	21 500	21 400	20 900	21 500	21 400	20 900	42,0		
44,0	54,7	52,8	20 700	20 500	20 300	20 700	20 500	20 300	44,0		
46,0	52,4	51,1	19 900	19 700	19 600	19 900	19 700	19 600	46,0		
48,0	50,0	49,2	19 200	19 000	18 900	19 200	19 000	18 900	48,0		
50,0	47,5	47,1	18 500	18 400	18 300	18 500	18 400	18 300	50,0		
52,0	44,9	44,9	17 800	17 700	17 600	17 800	17 700	17 600	52,0		
54,0	42,2	42,4	17 300	17 200	17 100	17 300	17 200	17 100	54,0		
56,0	39,2	39,6	16 700	16 600	16 600	16 700	16 600	16 600	56,0		
58,0	36,0	36,5	16 200	16 100	16 100	16 200	16 100	16 100	58,0		
60,0	32,5	33,0	15 700	15 700	15 600	15 700	15 700	15 600	60,0		
62,0	28,5	28,9	15 300	15 300	15 200	15 300	15 300	15 200	62,0		
64,0	23,8	23,8	15 000	14 900	14 800	15 000	14 900	14 800	64,0		



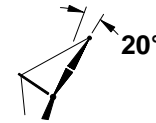
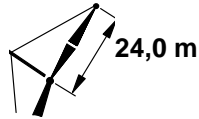
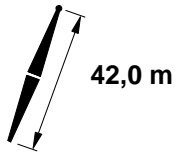
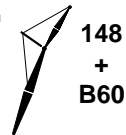





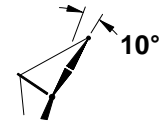
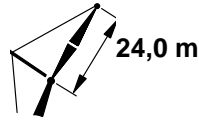
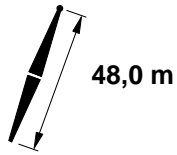

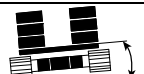
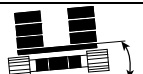
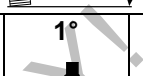

# MLC300 VPC-MAX S-2

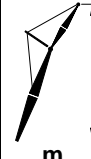

m	°	m	10,6 m			14,6 m			m			
			0°			1°				2°		
			kg	kg	kg	kg	kg	kg		kg	kg	
16,8										16,8		
18,0										18,0		
20,0	81,7	64,9	28 400 <sup>b</sup>	26 000 <sup>c</sup>		28 400 <sup>b</sup>	26 000 <sup>c</sup>			20,0		
22,0	79,9	64,2	26 800	25 500 <sup>b</sup>	22 900 <sup>c</sup>	26 800	25 500 <sup>b</sup>	22 900 <sup>c</sup>		22,0		
24,0	78,0	63,5	25 400	24 900	22 400 <sup>b</sup>	25 400	24 900	22 400 <sup>b</sup>		24,0		
26,0	76,1	62,8	24 100	24 000	22 000	24 100	24 000	22 000		26,0		
28,0	74,2	61,9	23 000	22 900	21 700	23 000	22 900	21 700		28,0		
30,0	72,3	61,0	22 000	21 800	21 300	22 000	21 800	21 300		30,0		
32,0	70,3	60,0	21 000	20 900	20 700	21 000	20 900	20 700		32,0		
34,0	68,3	58,9	20 100	20 000	19 800	20 100	20 000	19 800		34,0		
36,0	66,3	57,7	19 300	19 300	19 100	19 300	19 300	19 100		36,0		
38,0	64,2	56,4	18 600	18 500	18 400	18 600	18 500	18 400		38,0		
40,0	62,1	55,0	17 900	17 900	17 700	17 900	17 900	17 700		40,0		
42,0	59,9	53,5	17 300	17 200	17 100	17 300	17 200	17 100		42,0		
44,0	57,6	51,8	16 700	16 700	16 600	16 700	16 700	16 600		44,0		
46,0	55,2	50,1	16 200	16 100	16 100	16 200	16 100	16 100		46,0		
48,0	52,8	48,1	15 700	15 700	15 600	15 700	15 700	15 600		48,0		
50,0	50,2	46,0	15 200	15 200	15 100	15 200	15 200	15 100		50,0		
52,0	47,6	43,7	14 800	14 800	14 700	14 800	14 800	14 700		52,0		
54,0	44,7	41,1	14 400	14 400	14 300	14 400	14 400	14 300		54,0		
56,0	41,7	38,3	14 100	14 000	14 000	14 100	14 000	14 000		56,0		
58,0	38,3	35,1	13 800	13 700	13 700	13 800	13 700	13 700		58,0		
60,0	34,6	31,4	13 500	13 400	13 400	13 500	13 400	13 400		60,0		
62,0	30,4	27,0	13 300			13 300				62,0		
64,0										64,0		

# MLC300 VPC-MAX S-2



			 10,6 m			 14,6 m					
			 0°			 1°			 2°		
 m	 °	 m	 kg	 kg	 kg	 kg	 kg	 kg	 m		
13,7	84,6	73,2	38 100c			38 100c			13,7		
14,0	84,3	73,2	38 000c			38 000c			14,0		
16,0	82,7	72,8	36 800b	31 500c		36 800b	31 500c		16,0		
18,0	81,1	72,4	35 800	30 700b	27 000c	35 800	30 700b	27 000c	18,0		
20,0	79,5	71,9	34 800	29 900	26 400c	34 800	29 900	26 400c	20,0		
22,0	77,8	71,3	33 800	29 200	25 800b	33 800	29 200	25 800b	22,0		
24,0	76,1	70,7	32 900	28 600	25 300	32 900	28 600	25 300	24,0		
26,0	74,5	70,0	32 000	27 900	24 800	32 000	27 900	24 800	26,0		
28,0	72,8	69,2	31 200	27 300	24 300	31 200	27 300	24 300	28,0		
30,0	71,0	68,4	30 100	26 700	23 800	30 100	26 700	23 800	30,0		
32,0	69,3	67,5	28 700	26 100	23 400	28 700	26 100	23 400	32,0		
34,0	67,5	66,5	27 300	25 600	23 000	27 300	25 600	23 000	34,0		
36,0	65,7	65,5	26 100	25 100	22 500	26 100	25 100	22 500	36,0		
38,0	63,9	64,4	24 900	24 600	22 200	24 900	24 600	22 200	38,0		
40,0	62,1	63,1	23 900	23 700	21 800	23 900	23 700	21 800	40,0		
42,0	60,2	61,8	22 900	22 800	21 400	22 900	22 800	21 400	42,0		
44,0	58,2	60,4	22 000	21 900	21 100	22 000	21 900	21 100	44,0		
46,0	56,2	58,9	21 200	21 100	20 700	21 200	21 100	20 700	46,0		
48,0	54,2	57,3	20 500	20 300	20 100	20 500	20 300	20 100	48,0		
50,0	52,1	55,5	19 700	19 600	19 500	19 700	19 600	19 500	50,0		
52,0	49,9	53,7	19 100	19 000	18 800	19 100	19 000	18 800	52,0		
54,0	47,6	51,6	18 500	18 400	18 300	18 500	18 400	18 300	54,0		
56,0	45,2	49,4	17 900	17 800	17 700	17 900	17 800	17 700	56,0		
58,0	42,7	47,0	17 400	17 200	17 200	17 400	17 200	17 200	58,0		
60,0	40,1	44,3	16 900	16 800	16 700	16 900	16 800	16 700	60,0		
62,0	37,3	41,4	16 400	16 300	16 200	16 400	16 300	16 200	62,0		
64,0	34,2	38,2	16 000	15 900	15 800	16 000	15 900	15 800	64,0		
66,0	30,9	34,4	15 600	15 500	15 400	15 600	15 500	15 400	66,0		
68,0	27,1	30,1	15 200	15 100	15 100	15 200	15 100	15 100	68,0		
70,0	22,5	24,7	14 900	14 800	14 800	14 900	14 800	14 800	70,0		

# MLC300 VPC-MAX S-2



148  
+  
B60

175 100 kg

360°

48,0 m

24,0 m







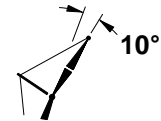
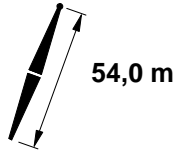

20°

m	°	m	10,6 m			14,6 m			m			
			0°			1°				2°		
			kg	kg	kg	kg	kg	kg		kg	kg	kg
13,7											13,7	
14,0											14,0	
16,0											16,0	
18,0											18,0	
20,0	82,4	71,0	29 000	26 100c	23 300c	29 000	26 100c	23 300c			20,0	
22,0	80,8	70,5	27 500	25 600b	23 000c	27 500	25 600b	23 000c			22,0	
24,0	79,1	69,8	26 100	25 100	22 600b	26 100	25 100	22 600b			24,0	
26,0	77,4	69,2	24 900	24 600	22 200	24 900	24 600	22 200			26,0	
28,0	75,6	68,4	23 800	23 700	21 900	23 800	23 700	21 900			28,0	
30,0	73,9	67,6	22 800	22 700	21 500	22 800	22 700	21 500			30,0	
32,0	72,1	66,6	21 800	21 700	21 200	21 800	21 700	21 200			32,0	
34,0	70,3	65,7	21 000	20 900	20 700	21 000	20 900	20 700			34,0	
36,0	68,5	64,6	20 200	20 100	19 900	20 200	20 100	19 900			36,0	
38,0	66,7	63,4	19 400	19 400	19 200	19 400	19 400	19 200			38,0	
40,0	64,8	62,2	18 800	18 700	18 600	18 800	18 700	18 600			40,0	
42,0	62,9	60,9	18 200	18 100	18 000	18 200	18 100	18 000			42,0	
44,0	60,9	59,5	17 600	17 500	17 400	17 600	17 500	17 400			44,0	
46,0	58,8	57,9	17 000	16 900	16 900	17 000	16 900	16 900			46,0	
48,0	56,8	56,3	16 500	16 500	16 400	16 500	16 500	16 400			48,0	
50,0	54,6	54,5	16 000	16 000	15 900	16 000	16 000	15 900			50,0	
52,0	52,4	52,5	15 600	15 600	15 500	15 600	15 600	15 500			52,0	
54,0	50,1	50,5	15 200	15 200	15 100	15 200	15 200	15 100			54,0	
56,0	47,6	48,2	14 800	14 800	14 700	14 800	14 800	14 700			56,0	
58,0	45,1	45,7	14 500	14 400	14 400	14 500	14 400	14 400			58,0	
60,0	42,3	43,0	14 100	14 100	14 100	14 100	14 100	14 100			60,0	
62,0	39,4	40,0	13 900	13 800	13 800	13 900	13 800	13 800			62,0	
64,0	36,3	36,5	13 600	13 500	13 500	13 600	13 500	13 500			64,0	
66,0	32,7	32,6	13 400	13 300	13 300	13 400	13 300	13 300			66,0	
68,0											68,0	
70,0											70,0	

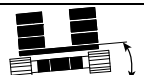
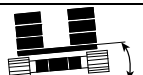
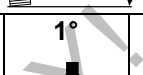

# MLC300 VPC-MAX S-2

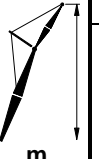
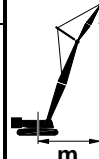

			 10,6 m			 14,6 m					
			 0°			 1°			 2°		
			 kg			 kg			 kg		
 m			 °			 m			 m		
13,7	85,0	79,3	38 100c			38 100c					13,7
14,0	84,8	79,3	38 000c			38 000c					14,0
16,0	83,3	78,9	36 900b	31 400c		36 900b	31 400c				16,0
18,0	81,8	78,5	36 000	30 700	27 000c	36 000	30 700	27 000c			18,0
20,0	80,3	78,0	35 000	30 100	26 500b	35 000	30 100	26 500b			20,0
22,0	78,8	77,5	34 200	29 400	26 000	34 200	29 400	26 000			22,0
24,0	77,3	77,0	33 300	28 800	25 500	33 300	28 800	25 500			24,0
26,0	75,7	76,3	32 500	28 200	25 000	32 500	28 200	25 000			26,0
28,0	74,2	75,6	31 700	27 700	24 600	31 700	27 700	24 600			28,0
30,0	72,6	74,9	31 000	27 100	24 100	31 000	27 100	24 100			30,0
32,0	71,0	74,1	30 100	26 600	23 700	30 100	26 600	23 700			32,0
34,0	69,4	73,2	28 700	26 100	23 300	28 700	26 100	23 300			34,0
36,0	67,8	72,2	27 500	25 600	22 900	27 500	25 600	22 900			36,0
38,0	66,1	71,2	26 300	25 100	22 500	26 300	25 100	22 500			38,0
40,0	64,5	70,1	25 200	24 600	22 200	25 200	24 600	22 200			40,0
42,0	62,8	68,9	24 200	24 000	21 800	24 200	24 000	21 800			42,0
44,0	61,0	67,7	23 300	23 200	21 500	23 300	23 200	21 500			44,0
46,0	59,3	66,4	22 500	22 300	21 200	22 500	22 300	21 200			46,0
48,0	57,5	64,9	21 700	21 500	20 800	21 700	21 500	20 800			48,0
50,0	55,6	63,4	21 000	20 800	20 500	21 000	20 800	20 500			50,0
52,0	53,7	61,8	20 300	20 100	20 000	20 300	20 100	20 000			52,0
54,0	51,8	60,0	19 600	19 500	19 400	19 600	19 500	19 400			54,0
56,0	49,7	58,1	19 000	18 900	18 800	19 000	18 900	18 800			56,0
58,0	47,7	56,1	18 500	18 400	18 200	18 500	18 400	18 200			58,0
60,0	45,5	53,9	17 900	17 800	17 700	17 900	17 800	17 700			60,0
62,0	43,2	51,6	17 500	17 400	17 200	17 500	17 400	17 200			62,0
64,0	40,8	49,0	17 000	16 900	16 800	17 000	16 900	16 800			64,0
66,0	38,3	46,2	16 500	16 500	16 400	16 500	16 500	16 400			66,0
68,0	35,6	43,1	16 100	16 100	16 000	16 100	16 100	16 000			68,0
70,0	32,7	39,7	15 800	15 700	15 600	15 800	15 700	15 600			70,0
72,0	29,5	35,8	15 400	15 300	15 300	15 400	15 300	15 300			72,0
74,0	25,8	31,2	15 100	15 000	15 000	15 100	15 000	15 000			74,0
76,0	21,5	25,6	14 800	14 800	14 700	14 800	14 800	14 700			76,0

# MLC300 VPC-MAX S-2

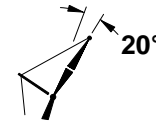
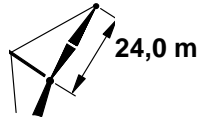
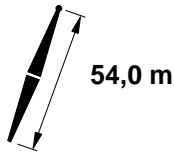
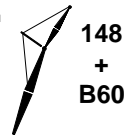

m	°	m	10,6 m			14,6 m			m			
			0°			1°				2°		
			kg	kg	kg	kg	kg	kg		kg	kg	kg
13,7											13,7	
14,0											14,0	
16,0											16,0	
18,0											18,0	
20,0	83,0	77,2	29 500	26 100b	23 000c	29 500	26 100b	23 000c			20,0	
22,0	81,5	76,7	28 100	25 700	23 000c	28 100	25 700	23 000c			22,0	
24,0	80,0	76,1	26 800	25 300	22 700	26 800	25 300	22 700			24,0	
26,0	78,4	75,5	25 600	24 900	22 300	25 600	24 900	22 300			26,0	
28,0	76,8	74,8	24 500	24 300	22 000	24 500	24 300	22 000			28,0	
30,0	75,2	74,0	23 500	23 400	21 700	23 500	23 400	21 700			30,0	
32,0	73,6	73,2	22 600	22 500	21 400	22 600	22 500	21 400			32,0	
34,0	72,0	72,3	21 700	21 700	21 100	21 700	21 700	21 100			34,0	
36,0	70,4	71,3	21 000	20 900	20 700	21 000	20 900	20 700			36,0	
38,0	68,7	70,3	20 200	20 200	20 000	20 200	20 200	20 000			38,0	
40,0	67,0	69,2	19 600	19 500	19 300	19 600	19 500	19 300			40,0	
42,0	65,3	68,0	18 900	18 800	18 700	18 900	18 800	18 700			42,0	
44,0	63,5	66,7	18 300	18 300	18 200	18 300	18 300	18 200			44,0	
46,0	61,7	65,4	17 800	17 700	17 600	17 800	17 700	17 600			46,0	
48,0	59,9	63,9	17 300	17 200	17 100	17 300	17 200	17 100			48,0	
50,0	58,0	62,3	16 800	16 700	16 700	16 800	16 700	16 700			50,0	
52,0	56,1	60,7	16 400	16 300	16 200	16 400	16 300	16 200			52,0	
54,0	54,1	58,9	15 900	15 900	15 800	15 900	15 900	15 800			54,0	
56,0	52,0	57,0	15 500	15 500	15 400	15 500	15 500	15 400			56,0	
58,0	49,9	54,9	15 200	15 100	15 100	15 200	15 100	15 100			58,0	
60,0	47,7	52,7	14 800	14 800	14 700	14 800	14 800	14 700			60,0	
62,0	45,4	50,3	14 500	14 500	14 400	14 500	14 500	14 400			62,0	
64,0	42,9	47,6	14 200	14 200	14 100	14 200	14 200	14 100			64,0	
66,0	40,3	44,8	13 900	13 900	13 900	13 900	13 900	13 900			66,0	
68,0	37,5	41,6	13 700	13 600	13 600	13 700	13 600	13 600			68,0	
70,0	34,5	38,0	13 500	13 400	13 400	13 500	13 400	13 400			70,0	
72,0	31,1	33,8	13 300	13 200	13 200	13 300	13 200	13 200			72,0	
74,0											74,0	
76,0											76,0	

# MLC300 VPC-MAX S-2

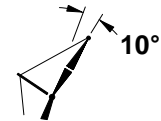
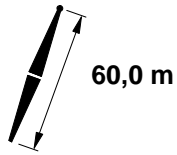

m	°	m	10,6 m			14,6 m			m			
			0°			1°				2°		
			kg	kg	kg	kg	kg	kg		kg	kg	kg
15,2	84,3	85,1	37 200			37 200				15,2		
16,0	83,8	85,0	36 900			36 900				16,0		
18,0	82,4	84,6	36 000	30 700		36 000	30 700			18,0		
20,0	81,0	84,2	35 200	30 100	26 400b	35 200	30 100	26 400b		20,0		
22,0	79,6	83,7	34 400	29 500	26 000	34 400	29 500	26 000		22,0		
24,0	78,2	83,2	33 600	29 000	25 500	33 600	29 000	25 500		24,0		
26,0	76,8	82,6	32 800	28 400	25 100	32 800	28 400	25 100		26,0		
28,0	75,3	82,0	32 100	27 900	24 700	32 100	27 900	24 700		28,0		
30,0	73,9	81,3	31 400	27 400	24 300	31 400	27 400	24 300		30,0		
32,0	72,4	80,5	30 800	26 900	23 900	30 800	26 900	23 900		32,0		
34,0	71,0	79,7	30 000	26 400	23 600	30 000	26 400	23 600		34,0		
36,0	69,5	78,9	28 700	25 900	23 200	28 700	25 900	23 200		36,0		
38,0	68,0	77,9	27 600	25 500	22 800	27 600	25 500	22 800		38,0		
40,0	66,5	76,9	26 500	25 100	22 500	26 500	25 100	22 500		40,0		
42,0	64,9	75,9	25 500	24 700	22 200	25 500	24 700	22 200		42,0		
44,0	63,4	74,7	24 500	24 100	21 800	24 500	24 100	21 800		44,0		
46,0	61,8	73,5	23 700	23 500	21 500	23 700	23 500	21 500		46,0		
48,0	60,1	72,2	22 900	22 700	21 200	22 900	22 700	21 200		48,0		
50,0	58,5	70,9	22 100	22 000	21 000	22 100	22 000	21 000		50,0		
52,0	56,8	69,4	21 400	21 300	20 700	21 400	21 300	20 700		52,0		
54,0	55,1	67,9	20 700	20 600	20 300	20 700	20 600	20 300		54,0		
56,0	53,3	66,2	20 100	20 000	19 900	20 100	20 000	19 900		56,0		
58,0	51,5	64,5	19 500	19 400	19 300	19 500	19 400	19 300		58,0		
60,0	49,6	62,6	19 000	18 900	18 800	19 000	18 900	18 800		60,0		
62,0	47,7	60,6	18 500	18 400	18 300	18 500	18 400	18 300		62,0		
64,0	45,7	58,4	18 000	17 900	17 800	18 000	17 900	17 800		64,0		
66,0	43,6	56,1	17 500	17 400	17 300	17 500	17 400	17 300		66,0		
68,0	41,4	53,6	17 100	17 000	16 900	17 100	17 000	16 900		68,0		
70,0	39,2	51,0	16 700	16 600	16 500	16 700	16 600	16 500		70,0		
72,0	36,7	48,0	16 300	16 200	16 100	16 300	16 200	16 100		72,0		
74,0	34,1	44,8	15 900	15 900	15 800	15 900	15 900	15 800		74,0		
76,0	31,3	41,2	15 600	15 500	15 400	15 600	15 500	15 400		76,0		
78,0	28,2	37,1	15 300	15 200	15 200	15 300	15 200	15 200		78,0		
80,0	24,7	32,3	15 000	14 900	14 900	15 000	14 900	14 900		80,0		
82,0	20,5	26,5	14 800	14 700	14 600	14 800	14 700	14 600		82,0		

# MLC300 VPC-MAX S-2



148  
+  
B60

175 100 kg

360°

60,0 m

24,0 m

20°

			10,6 m			14,6 m					
			0°			1°			2°		
m	°	m	kg	kg	kg	kg	kg	kg	kg	m	
15,2										15,2	
16,0										16,0	
18,0										18,0	
20,0	83,5	83,3	29 900	26 100 <sup>b</sup>	23 000 <sup>c</sup>	29 900	26 100 <sup>b</sup>	23 000 <sup>c</sup>		20,0	
22,0	82,1	82,8	28 600	25 700		28 600	25 700			22,0	
24,0	80,7	82,3	27 300	25 300	22 700	27 300	25 300	22 700		24,0	
26,0	79,3	81,7	26 200	24 900	22 400	26 200	24 900	22 400		26,0	
28,0	77,8	81,1	25 100	24 600	22 100	25 100	24 600	22 100		28,0	
30,0	76,4	80,4	24 200	24 000	21 800	24 200	24 000	21 800		30,0	
32,0	74,9	79,6	23 200	23 100	21 500	23 200	23 100	21 500		32,0	
34,0	73,4	78,8	22 400	22 300	21 300	22 400	22 300	21 300		34,0	
36,0	71,9	77,9	21 600	21 600	21 000	21 600	21 600	21 000		36,0	
38,0	70,4	77,0	20 900	20 800	20 700	20 900	20 800	20 700		38,0	
40,0	68,8	76,0	20 300	20 200	20 000	20 300	20 200	20 000		40,0	
42,0	67,3	74,9	19 600	19 600	19 400	19 600	19 600	19 400		42,0	
44,0	65,7	73,8	19 100	19 000	18 900	19 100	19 000	18 900		44,0	
46,0	64,1	72,5	18 500	18 400	18 300	18 500	18 400	18 300		46,0	
48,0	62,4	71,2	18 000	17 900	17 800	18 000	17 900	17 800		48,0	
50,0	60,7	69,8	17 500	17 400	17 400	17 500	17 400	17 400		50,0	
52,0	59,0	68,4	17 000	17 000	16 900	17 000	17 000	16 900		52,0	
54,0	57,3	66,8	16 600	16 600	16 500	16 600	16 600	16 500		54,0	
56,0	55,5	65,1	16 200	16 200	16 100	16 200	16 200	16 100		56,0	
58,0	53,6	63,3	15 800	15 800	15 700	15 800	15 800	15 700		58,0	
60,0	51,7	61,4	15 500	15 400	15 400	15 500	15 400	15 400		60,0	
62,0	49,8	59,4	15 100	15 100	15 000	15 100	15 100	15 000		62,0	
64,0	47,7	57,2	14 800	14 800	14 700	14 800	14 800	14 700		64,0	
66,0	45,6	54,8	14 500	14 500	14 500	14 500	14 500	14 500		66,0	
68,0	43,4	52,3	14 300	14 200	14 200	14 300	14 200	14 200		68,0	
70,0	41,0	49,5	14 000	14 000	13 900	14 000	14 000	13 900		70,0	
72,0	38,5	46,5	13 800	13 700	13 700	13 800	13 700	13 700		72,0	
74,0	35,8	43,1	13 500	13 500	13 500	13 500	13 500	13 500		74,0	
76,0	32,9	39,3	13 400	13 300	13 300	13 400	13 300	13 300		76,0	
78,0										78,0	
80,0										80,0	
82,0										82,0	

# MLC300 VPC-MAX S-2

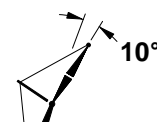
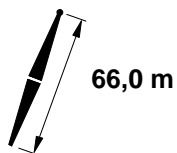

m	°	m	10,6 m			14,6 m			m
			0°			0°			
			kg	kg	kg	kg	kg	kg	
15,2	84,7	91,2	37 100			37 100			15,2
16,0	84,2	91,0	36 800			36 800			16,0
18,0	82,9	90,7	36 000	30 600		36 000	30 600		18,0
20,0	81,6	90,3	35 200	30 000	26 300	35 200	30 000	26 300	20,0
22,0	80,3	89,9	34 500	29 500	25 900	34 500	29 500	25 900	22,0
24,0	79,0	89,4	33 700	29 000	25 500	33 700	29 000	25 500	24,0
26,0	77,7	88,8	33 000	28 500	25 100	33 000	28 500	25 100	26,0
28,0	76,3	88,2	32 400	28 000	24 800	32 400	28 000	24 800	28,0
30,0	75,0	87,6	31 700	27 600	24 400	31 700	27 600	24 400	30,0
32,0	73,7	86,9	31 100	27 100	24 000	31 100	27 100	24 000	32,0
34,0	72,3	86,2	30 500	26 600	23 700	30 500	26 600	23 700	34,0
36,0	70,9	85,4	29 800	26 200	23 400	29 800	26 200	23 400	36,0
38,0	69,6	84,5	28 700	25 800	23 000	28 700	25 800	23 000	38,0
40,0	68,2	83,6	27 600	25 400	22 700	27 600	25 400	22 700	40,0
42,0	66,7	82,6	26 600	25 000	22 400	26 600	25 000	22 400	42,0
44,0	65,3	81,6	25 700	24 600	22 100	25 700	24 600	22 100	44,0
46,0	63,8	80,5	24 800	24 200	21 800	24 800	24 200	21 800	46,0
48,0	62,4	79,3	24 000	23 700	21 500	24 000	23 700	21 500	48,0
50,0	60,9	78,0	23 200	23 000	21 300	23 200	23 000	21 300	50,0
52,0	59,4	76,7	22 500	22 300	21 000	22 500	22 300	21 000	52,0
54,0	57,8	75,3	21 800	21 600	20 800	21 800	21 600	20 800	54,0
56,0	56,2	73,9	21 200	21 000	20 500	21 200	21 000	20 500	56,0
58,0	54,6	72,3	20 500	20 400	20 300	20 500	20 400	20 300	58,0
60,0	52,9	70,6	20 000	19 900	19 700	20 000	19 900	19 700	60,0
62,0	51,3	68,9	19 500	19 300	19 200	19 500	19 300	19 200	62,0
64,0	49,5	67,0	18 900	18 800	18 700	18 900	18 800	18 700	64,0
66,0	47,7	65,0	18 500	18 400	18 200	18 500	18 400	18 200	66,0
68,0	45,9	62,9	18 000	17 900	17 800	18 000	17 900	17 800	68,0
70,0	43,9	60,6	17 600	17 500	17 400	17 600	17 500	17 400	70,0
72,0	41,9	58,2	17 200	17 100	17 000	17 200	17 100	17 000	72,0
74,0	39,8	55,6	16 800	16 700	16 600	16 800	16 700	16 600	74,0
76,0	37,6	52,8	16 400	16 400	16 300	16 400	16 400	16 300	76,0
78,0	35,3	49,7	16 100	16 000	15 900	16 100	16 000	15 900	78,0
80,0	32,8	46,3	15 800	15 700	15 600	15 800	15 700	15 600	80,0
82,0	30,1	42,6	15 500	15 400	15 300	15 500	15 400	15 300	82,0
84,0	27,1	38,3	15 200	15 100	15 100	15 200	15 100	15 100	84,0
88,0	19,6	27,2	14 500	14 300	14 100	14 800	14 700	14 600	88,0

# MLC300 VPC-MAX S-2



148  
+  
B60

175 100 kg

360°

66,0 m

24,0 m

20°

m	°	m	10,6 m			14,6 m			m
			0°	1°	2°	0°	1°	2°	
			kg	kg	kg	kg	kg	kg	
15,2									15,2
16,0									16,0
18,0									18,0
20,0	84,0	89,4	30 300			30 300			20,0
22,0	82,7	89,0	29 000			29 000	25 700		22,0
24,0	81,3	88,5	27 800	25 300	22 600	27 800	25 300	22 600	24,0
26,0	80,0	87,9	26 700	25 000	22 400	26 700	25 000	22 400	26,0
28,0	78,7	87,3	25 700	24 700	22 100	25 700	24 700	22 100	28,0
30,0	77,3	86,7	24 700	24 400	21 900	24 700	24 400	21 900	30,0
32,0	76,0	86,0	23 900	23 700	21 600	23 900	23 700	21 600	32,0
34,0	74,6	85,2	23 000	22 900	21 400	23 000	22 900	21 400	34,0
36,0	73,2	84,4	22 300	22 200	21 200	22 300	22 200	21 200	36,0
38,0	71,8	83,5	21 600	21 500	20 900	21 600	21 500	20 900	38,0
40,0	70,4	82,6	20 900	20 800	20 700	20 900	20 800	20 700	40,0
42,0	68,9	81,6	20 300	20 200	20 100	20 300	20 200	20 100	42,0
44,0	67,5	80,6	19 700	19 600	19 500	19 700	19 600	19 500	44,0
46,0	66,0	79,5	19 200	19 100	19 000	19 200	19 100	19 000	46,0
48,0	64,5	78,3	18 600	18 600	18 500	18 600	18 600	18 500	48,0
50,0	63,0	77,0	18 100	18 100	18 000	18 100	18 100	18 000	50,0
52,0	61,5	75,7	17 700	17 600	17 500	17 700	17 600	17 500	52,0
54,0	59,9	74,3	17 200	17 200	17 100	17 200	17 200	17 100	54,0
56,0	58,3	72,8	16 900	16 800	16 700	16 900	16 800	16 700	56,0
58,0	56,6	71,2	16 500	16 400	16 300	16 500	16 400	16 300	58,0
60,0	55,0	69,5	16 100	16 000	16 000	16 100	16 000	16 000	60,0
62,0	53,2	67,7	15 700	15 700	15 600	15 700	15 700	15 600	62,0
64,0	51,5	65,8	15 400	15 400	15 300	15 400	15 400	15 300	64,0
66,0	49,6	63,8	15 100	15 100	15 000	15 100	15 100	15 000	66,0
68,0	47,7	61,6	14 800	14 800	14 700	14 800	14 800	14 700	68,0
70,0	45,8	59,3	14 600	14 500	14 500	14 600	14 500	14 500	70,0
72,0	43,7	56,8	14 300	14 300	14 200	14 300	14 300	14 200	72,0
74,0	41,6	54,1	14 100	14 000	14 000	14 100	14 000	14 000	74,0
76,0	39,3	51,2	13 800	13 800	13 700	13 800	13 800	13 700	76,0
78,0	36,9	48,0	13 600	13 600	13 600	13 600	13 600	13 600	78,0
80,0	34,3	44,5	13 400	13 400	13 400	13 400	13 400	13 400	80,0
82,0	31,5	40,6	13 300	13 200	13 200	13 300	13 200	13 200	82,0
84,0									84,0
88,0									88,0

# MLC300 VPC-MAX S-2

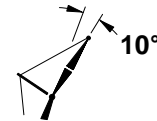
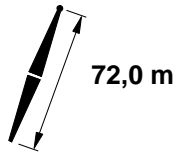

m	°	m	10,6 m			14,6 m			m			
			0°			1°				2°		
			kg	kg	kg	kg	kg	kg		kg	kg	kg
16,8	84,1	97,0	36 200			36 200			16,8			
18,0	83,4	96,8	35 800			35 800			18,0			
20,0	82,1	96,4	35 100	29 900	26 100	35 100	29 900	26 100	20,0			
22,0	80,9	96,0	34 500	29 400	25 800	34 500	29 400	25 800	22,0			
24,0	79,7	95,5	33 800	28 900	25 400	33 800	28 900	25 400	24,0			
26,0	78,5	95,0	33 200	28 500	25 100	33 200	28 500	25 100	26,0			
28,0	77,2	94,5	32 500	28 000	24 700	32 500	28 000	24 700	28,0			
30,0	76,0	93,9	31 900	27 600	24 400	31 900	27 600	24 400	30,0			
32,0	74,7	93,2	31 400	27 200	24 100	31 400	27 200	24 100	32,0			
34,0	73,5	92,5	30 800	26 800	23 800	30 800	26 800	23 800	34,0			
36,0	72,2	91,8	30 300	26 400	23 400	30 300	26 400	23 400	36,0			
38,0	70,9	91,0	29 700	26 000	23 100	29 700	26 000	23 100	38,0			
40,0	69,6	90,2	28 700	25 600	22 900	28 700	25 600	22 900	40,0			
42,0	68,3	89,3	27 700	25 300	22 600	27 700	25 300	22 600	42,0			
44,0	67,0	88,3	26 700	24 900	22 300	26 700	24 900	22 300	44,0			
46,0	65,6	87,3	25 900	24 600	22 000	25 900	24 600	22 000	46,0			
48,0	64,3	86,2	25 000	24 200	21 800	25 000	24 200	21 800	48,0			
50,0	62,9	85,1	24 200	23 800	21 500	24 200	23 800	21 500	50,0			
52,0	61,5	83,9	23 500	23 300	21 300	23 500	23 300	21 300	52,0			
54,0	60,1	82,6	22 800	22 600	21 000	22 800	22 600	21 000	54,0			
56,0	58,7	81,3	22 200	22 000	20 800	22 200	22 000	20 800	56,0			
58,0	57,2	79,8	21 500	21 400	20 500	21 500	21 400	20 500	58,0			
60,0	55,7	78,3	21 000	20 800	20 300	21 000	20 800	20 300	60,0			
62,0	54,2	76,8	20 400	20 300	20 000	20 400	20 300	20 000	62,0			
64,0	52,7	75,1	19 900	19 800	19 600	19 900	19 800	19 600	64,0			
66,0	51,1	73,3	19 400	19 300	19 100	19 400	19 300	19 100	66,0			
68,0	49,4	71,5	18 900	18 800	18 700	18 900	18 800	18 700	68,0			
70,0	47,8	69,5	18 500	18 400	18 200	18 500	18 400	18 200	70,0			
72,0	46,0	67,4	18 100	17 900	17 800	18 100	17 900	17 800	72,0			
74,0	44,2	65,2	17 600	17 500	17 500	17 600	17 500	17 500	74,0			
76,0	42,4	62,8	17 300	17 200	17 100	17 300	17 200	17 100	76,0			
78,0	40,5	60,3	16 900	16 800	16 700	16 900	16 800	16 700	78,0			
80,0	38,4	57,5	16 600	16 400	16 200	16 600	16 500	16 400	80,0			
82,0	36,3	54,6	16 200	15 900	15 500	16 200	16 200	16 100	82,0			
84,0	34,0	51,4	15 500	15 100	14 600	15 900	15 800	15 800	84,0			
88,0	29,0	43,9	13 700	13 300	13 000	15 400	15 300	15 200	88,0			
92,0	22,8	34,4	12 000			14 900			92,0			

# MLC300 VPC-MAX S-2

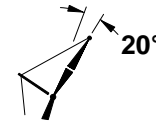
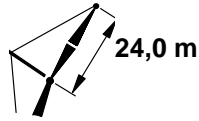
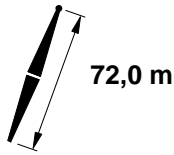

			10,6 m			14,6 m					
			0°			1°			2°		
m	°	m	kg	kg	kg	kg	kg	kg	kg	m	
16,8										16,8	
18,0										18,0	
20,0	84,4	95,5	30 600			30 600				20,0	
22,0	83,1	95,1	29 400	25 600		29 400	25 600			22,0	
24,0	81,9	94,6	28 200	25 300	22 500	28 200	25 300	22 500		24,0	
26,0	80,7	94,1	27 200	25 000	22 300	27 200	25 000	22 300		26,0	
28,0	79,4	93,6	26 200	24 700	22 100	26 200	24 700	22 100		28,0	
30,0	78,2	93,0	25 300	24 400	21 800	25 300	24 400	21 800		30,0	
32,0	76,9	92,3	24 400	24 100	21 600	24 400	24 100	21 600		32,0	
34,0	75,6	91,6	23 600	23 500	21 400	23 600	23 500	21 400		34,0	
36,0	74,3	90,9	22 900	22 700	21 200	22 900	22 700	21 200		36,0	
38,0	73,0	90,1	22 200	22 000	21 000	22 200	22 000	21 000		38,0	
40,0	71,7	89,2	21 500	21 400	20 800	21 500	21 400	20 800		40,0	
42,0	70,4	88,3	20 900	20 800	20 600	20 900	20 800	20 600		42,0	
44,0	69,1	87,3	20 300	20 200	20 100	20 300	20 200	20 100		44,0	
46,0	67,7	86,3	19 800	19 700	19 600	19 800	19 700	19 600		46,0	
48,0	66,3	85,2	19 200	19 200	19 100	19 200	19 200	19 100		48,0	
50,0	64,9	84,0	18 800	18 700	18 600	18 800	18 700	18 600		50,0	
52,0	63,5	82,8	18 300	18 200	18 200	18 300	18 200	18 200		52,0	
54,0	62,1	81,5	17 900	17 800	17 700	17 900	17 800	17 700		54,0	
56,0	60,6	80,2	17 500	17 400	17 300	17 500	17 400	17 300		56,0	
58,0	59,2	78,7	17 100	17 000	16 900	17 100	17 000	16 900		58,0	
60,0	57,6	77,2	16 700	16 600	16 600	16 700	16 600	16 600		60,0	
62,0	56,1	75,6	16 300	16 300	16 200	16 300	16 300	16 200		62,0	
64,0	54,5	73,9	16 000	16 000	15 900	16 000	16 000	15 900		64,0	
66,0	52,9	72,1	15 700	15 600	15 600	15 700	15 600	15 600		66,0	
68,0	51,2	70,2	15 400	15 300	15 300	15 400	15 300	15 300		68,0	
70,0	49,5	68,2	15 100	15 000	15 000	15 100	15 000	15 000		70,0	
72,0	47,8	66,1	14 800	14 800	14 700	14 800	14 800	14 700		72,0	
74,0	45,9	63,8	14 600	14 500	14 500	14 600	14 500	14 500		74,0	
76,0	44,1	61,4	14 300	14 300	14 300	14 300	14 300	14 300		76,0	
78,0	42,1	58,8	14 100	14 100	14 000	14 100	14 100	14 000		78,0	
80,0	40,0	56,0	13 900	13 900	13 800	13 900	13 900	13 800		80,0	
82,0	37,8	52,9	13 700	13 700	13 600	13 700	13 700	13 600		82,0	
84,0	35,5	49,6	13 500	13 500	13 400	13 500	13 500	13 400		84,0	
88,0	30,2	41,9	13 200	13 200	13 100	13 200	13 200	13 200		88,0	
92,0										92,0	



# MLC300 VPC-MAX S-2

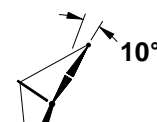
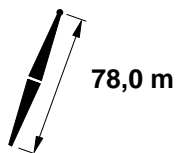

m	°	m	10,6 m			14,6 m			m
			0°			0°			
			kg	kg	kg	kg	kg	kg	
16,8	84,5	103,1	35 800			35 800			16,8
18,0	83,8	102,9	35 400			35 400			18,0
20,0	82,6	102,5	34 800	28 400	24 900	34 800	28 400	24 900	20,0
22,0	81,5	102,1	34 200	28 000	24 600	34 200	28 000	24 600	22,0
24,0	80,3	101,7	33 600	27 600	24 300	33 600	27 600	24 300	24,0
26,0	79,2	101,2	33 000	27 200	24 000	33 000	27 200	24 000	26,0
28,0	78,0	100,7	32 500	26 900	23 700	32 500	26 900	23 700	28,0
30,0	76,8	100,1	32 000	26 500	23 500	32 000	26 500	23 500	30,0
32,0	75,7	99,5	31 400	26 100	23 200	31 400	26 100	23 200	32,0
34,0	74,5	98,9	30 900	25 800	22 900	30 900	25 800	22 900	34,0
36,0	73,3	98,2	30 400	25 400	22 600	30 400	25 400	22 600	36,0
38,0	72,1	97,5	29 900	25 100	22 400	29 900	25 100	22 400	38,0
40,0	70,9	96,7	29 400	24 800	22 100	29 400	24 800	22 100	40,0
42,0	69,7	95,8	28 600	24 400	21 900	28 600	24 400	21 900	42,0
44,0	68,4	94,9	27 600	24 100	21 600	27 600	24 100	21 600	44,0
46,0	67,2	94,0	26 700	23 800	21 400	26 700	23 800	21 400	46,0
48,0	65,9	93,0	25 900	23 500	21 200	25 900	23 500	21 200	48,0
50,0	64,7	92,0	25 100	23 300	20 900	25 100	23 300	20 900	50,0
52,0	63,4	90,8	24 400	23 000	20 700	24 400	23 000	20 700	52,0
54,0	62,1	89,7	23 600	22 700	20 500	23 600	22 700	20 500	54,0
56,0	60,8	88,4	23 000	22 400	20 300	23 000	22 400	20 300	56,0
58,0	59,4	87,1	22 400	22 200	20 100	22 400	22 200	20 100	58,0
60,0	58,1	85,8	21 800	21 600	19 900	21 800	21 600	19 900	60,0
62,0	56,7	84,3	21 200	21 100	19 700	21 200	21 100	19 700	62,0
64,0	55,3	82,8	20 700	20 500	19 500	20 700	20 500	19 500	64,0
66,0	53,9	81,2	20 200	20 000	19 300	20 200	20 000	19 300	66,0
68,0	52,4	79,6	19 700	19 600	19 200	19 700	19 600	19 200	68,0
70,0	50,9	77,8	19 300	19 100	19 000	19 300	19 100	19 000	70,0
72,0	49,4	75,9	18 800	18 700	18 600	18 800	18 700	18 600	72,0
74,0	47,8	74,0	18 400	18 300	18 000	18 400	18 300	18 200	74,0
76,0	46,2	71,9	18 000	17 900	17 400	18 000	17 900	17 800	76,0
78,0	44,5	69,7	17 600	17 000	16 400	17 600	17 500	17 400	78,0
80,0	42,8	67,4	16 700	16 100	15 500	17 300	17 200	17 100	80,0
82,0	41,0	64,9	15 700	15 100	14 500	17 000	16 900	16 800	82,0
84,0	39,1	62,2	14 700	14 200	13 700	16 600	16 500	16 500	84,0
88,0	35,1	56,3	12 900	12 500	12 000	16 000	15 900	15 900	88,0
92,0	30,6	49,3	11 300	10 900	10 500	15 500	15 400	15 300	92,0
96,0	25,2	40,7	9 700	9 400	9 100	15 000	15 000	14 900	96,0

# MLC300 VPC-MAX S-2



148  
+  
B60

175 100 kg

360°

78,0 m

24,0 m

20°

m	°	m	10,6 m			14,6 m			m			
			0°			1°				2°		
			kg	kg	kg	kg	kg	kg		kg	kg	kg
16,8										16,8		
18,0										18,0		
20,0	84,7	101,6	30 800			30 800				20,0		
22,0	83,6	101,2	29 600	25 300		29 600	25 300			22,0		
24,0	82,4	100,8	28 500	25 100		28 500	25 100			24,0		
26,0	81,2	100,3	27 500	24 800	22 100	27 500	24 800	22 100		26,0		
28,0	80,1	99,8	26 600	24 500	21 900	26 600	24 500	21 900		28,0		
30,0	78,9	99,2	25 700	24 300	21 700	25 700	24 300	21 700		30,0		
32,0	77,7	98,6	24 800	24 000	21 500	24 800	24 000	21 500		32,0		
34,0	76,5	97,9	24 100	23 700	21 300	24 100	23 700	21 300		34,0		
36,0	75,3	97,2	23 300	23 200	21 100	23 300	23 200	21 100		36,0		
38,0	74,1	96,5	22 700	22 500	20 900	22 700	22 500	20 900		38,0		
40,0	72,9	95,7	22 000	21 900	20 800	22 000	21 900	20 800		40,0		
42,0	71,6	94,8	21 400	21 300	20 600	21 400	21 300	20 600		42,0		
44,0	70,4	93,9	20 800	20 700	20 400	20 800	20 700	20 400		44,0		
46,0	69,1	93,0	20 300	20 200	20 100	20 300	20 200	20 100		46,0		
48,0	67,9	92,0	19 800	19 700	19 600	19 800	19 700	19 600		48,0		
50,0	66,6	90,9	19 300	19 200	19 100	19 300	19 200	19 100		50,0		
52,0	65,3	89,8	18 800	18 700	18 600	18 800	18 700	18 600		52,0		
54,0	64,0	88,6	18 400	18 300	18 200	18 400	18 300	18 200		54,0		
56,0	62,6	87,4	18 000	17 900	17 800	18 000	17 900	17 800		56,0		
58,0	61,3	86,1	17 600	17 500	17 400	17 600	17 500	17 400		58,0		
60,0	59,9	84,7	17 200	17 100	17 100	17 200	17 100	17 100		60,0		
62,0	58,5	83,2	16 800	16 800	16 700	16 800	16 800	16 700		62,0		
64,0	57,1	81,7	16 500	16 400	16 400	16 500	16 400	16 400		64,0		
66,0	55,6	80,1	16 200	16 100	16 100	16 200	16 100	16 100		66,0		
68,0	54,1	78,4	15 900	15 800	15 800	15 900	15 800	15 800		68,0		
70,0	52,6	76,6	15 600	15 500	15 500	15 600	15 500	15 500		70,0		
72,0	51,1	74,7	15 300	15 300	15 200	15 300	15 300	15 200		72,0		
74,0	49,5	72,7	15 100	15 000	14 900	15 100	15 000	14 900		74,0		
76,0	47,8	70,6	14 800	14 800	14 700	14 800	14 800	14 700		76,0		
78,0	46,1	68,3	14 600	14 500	14 500	14 600	14 500	14 500		78,0		
80,0	44,3	65,9	14 300	14 300	14 300	14 300	14 300	14 300		80,0		
82,0	42,5	63,4	14 100	14 100	14 100	14 100	14 100	14 100		82,0		
84,0	40,6	60,7	13 900	13 900	13 700	13 900	13 900	13 900		84,0		
88,0	36,5	54,6	13 200	12 800	12 300	13 600	13 500	13 500		88,0		
92,0	31,8	47,3	11 500	11 100	10 800	13 300	13 300	13 200		92,0		
96,0										96,0		

# MLC300 VPC-MAX S-2

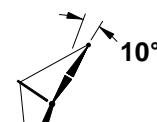
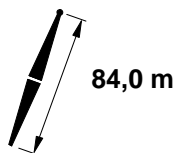

m	°	m	10,6 m			14,6 m			m			
			0°			1°				2°		
			kg	kg	kg	kg	kg	kg		kg	kg	kg
16,8	84,8	109,1	35 400			35 400			16,8			
18,0	84,1	108,9	35 100			35 100			18,0			
20,0	83,0	108,6	34 500	28 100		34 500	28 100		20,0			
22,0	81,9	108,2	34 000	27 800	24 300	34 000	27 800	24 300	22,0			
24,0	80,9	107,8	33 400	27 400	24 100	33 400	27 400	24 100	24,0			
26,0	79,8	107,4	32 900	27 100	23 800	32 900	27 100	23 800	26,0			
28,0	78,7	106,9	32 400	26 700	23 600	32 400	26 700	23 600	28,0			
30,0	77,6	106,4	31 900	26 400	23 300	31 900	26 400	23 300	30,0			
32,0	76,5	105,8	31 400	26 100	23 000	31 400	26 100	23 000	32,0			
34,0	75,4	105,2	31 000	25 700	22 800	31 000	25 700	22 800	34,0			
36,0	74,3	104,5	30 500	25 400	22 500	30 500	25 400	22 500	36,0			
38,0	73,1	103,9	30 000	25 100	22 300	30 000	25 100	22 300	38,0			
40,0	72,0	103,1	29 600	24 800	22 100	29 600	24 800	22 100	40,0			
42,0	70,9	102,3	29 200	24 500	21 900	29 200	24 500	21 900	42,0			
44,0	69,7	101,5	28 500	24 200	21 600	28 500	24 200	21 600	44,0			
46,0	68,6	100,6	27 600	24 000	21 400	27 600	24 000	21 400	46,0			
48,0	67,4	99,7	26 800	23 700	21 200	26 800	23 700	21 200	48,0			
50,0	66,2	98,7	26 000	23 400	21 000	26 000	23 400	21 000	50,0			
52,0	65,0	97,7	25 200	23 100	20 800	25 200	23 100	20 800	52,0			
54,0	63,8	96,6	24 500	22 900	20 600	24 500	22 900	20 600	54,0			
56,0	62,6	95,5	23 800	22 600	20 400	23 800	22 600	20 400	56,0			
58,0	61,4	94,3	23 200	22 400	20 200	23 200	22 400	20 200	58,0			
60,0	60,1	93,0	22 600	22 100	20 000	22 600	22 100	20 000	60,0			
62,0	58,8	91,7	22 100	21 800	19 900	22 100	21 800	19 900	62,0			
64,0	57,5	90,3	21 500	21 300	19 700	21 500	21 300	19 700	64,0			
66,0	56,2	88,8	21 000	20 800	19 500	21 000	20 800	19 500	66,0			
68,0	54,9	87,3	20 500	20 400	19 400	20 500	20 400	19 400	68,0			
70,0	53,5	85,7	20 000	19 900	19 200	20 000	19 900	19 200	70,0			
72,0	52,2	84,0	19 600	19 100	18 300	19 600	19 500	19 000	72,0			
74,0	50,7	82,3	18 900	18 100	17 300	19 200	19 000	18 800	74,0			
76,0	49,3	80,4	17 800	17 000	16 200	18 800	18 700	18 500	76,0			
78,0	47,8	78,5	16 700	15 900	15 200	18 400	18 300	18 100	78,0			
80,0	46,3	76,4	15 600	14 900	14 300	18 000	17 900	17 800	80,0			
82,0	44,7	74,2	14 600	14 000	13 400	17 700	17 600	17 500	82,0			
84,0	43,1	71,9	13 700	13 100	12 500	17 300	17 200	17 100	84,0			
88,0	39,7	66,9	11 900	11 400	10 900	16 700	16 600	16 500	88,0			
92,0	36,0	61,2	10 200	9 800	9 400	16 100	16 100	16 000	92,0			
96,0	31,9	54,6	8 700	8 400	8 000	15 700	15 600	15 500	96,0			
100,0	27,1	46,6	7 300	7 000	6 700	15 200	14 900	14 500	100,0			
104,0	21,3	36,3	5 900			14 000			104,0			

# MLC300 VPC-MAX S-2

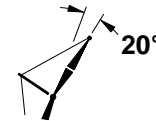
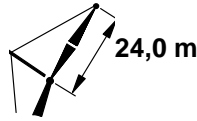
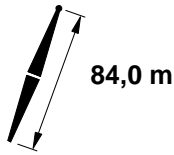
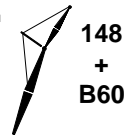

m	°	m	10,6 m			14,6 m			m			
			0°			1°				2°		
			kg	kg	kg	kg	kg	kg		kg	kg	kg
16,8											16,8	
18,0											18,0	
20,0											20,0	
22,0	83,9	107,3	29 900			29 900					22,0	
24,0	82,8	106,9	28 800	24 900		28 800	24 900				24,0	
26,0	81,7	106,4	27 800	24 600	21 900	27 800	24 600	21 900			26,0	
28,0	80,6	106,0	26 900	24 400	21 700	26 900	24 400	21 700			28,0	
30,0	79,5	105,4	26 100	24 200	21 600	26 100	24 200	21 600			30,0	
32,0	78,4	104,9	25 300	23 900	21 400	25 300	23 900	21 400			32,0	
34,0	77,3	104,2	24 500	23 700	21 200	24 500	23 700	21 200			34,0	
36,0	76,2	103,6	23 800	23 500	21 100	23 800	23 500	21 100			36,0	
38,0	75,0	102,9	23 100	23 000	20 900	23 100	23 000	20 900			38,0	
40,0	73,9	102,1	22 500	22 300	20 800	22 500	22 300	20 800			40,0	
42,0	72,7	101,3	21 900	21 800	20 600	21 900	21 800	20 600			42,0	
44,0	71,6	100,5	21 300	21 200	20 400	21 300	21 200	20 400			44,0	
46,0	70,4	99,6	20 800	20 700	20 300	20 800	20 700	20 300			46,0	
48,0	69,2	98,7	20 300	20 200	20 000	20 300	20 200	20 000			48,0	
50,0	68,0	97,7	19 800	19 700	19 600	19 800	19 700	19 600			50,0	
52,0	66,8	96,6	19 300	19 200	19 100	19 300	19 200	19 100			52,0	
54,0	65,6	95,5	18 900	18 800	18 700	18 900	18 800	18 700			54,0	
56,0	64,4	94,4	18 500	18 400	18 300	18 500	18 400	18 300			56,0	
58,0	63,1	93,2	18 100	18 000	17 900	18 100	18 000	17 900			58,0	
60,0	61,9	91,9	17 700	17 600	17 500	17 700	17 600	17 500			60,0	
62,0	60,6	90,6	17 400	17 300	17 200	17 400	17 300	17 200			62,0	
64,0	59,3	89,2	17 000	16 900	16 900	17 000	16 900	16 900			64,0	
66,0	57,9	87,7	16 700	16 600	16 600	16 700	16 600	16 600			66,0	
68,0	56,6	86,2	16 400	16 300	16 200	16 400	16 300	16 200			68,0	
70,0	55,2	84,5	16 100	16 000	16 000	16 100	16 000	16 000			70,0	
72,0	53,8	82,8	15 800	15 700	15 700	15 800	15 700	15 700			72,0	
74,0	52,4	81,0	15 500	15 500	15 400	15 500	15 500	15 400			74,0	
76,0	50,9	79,1	15 300	15 200	15 100	15 300	15 200	15 100			76,0	
78,0	49,4	77,2	15 000	15 000	14 900	15 000	15 000	14 900			78,0	
80,0	47,8	75,1	14 800	14 700	14 500	14 800	14 700	14 700			80,0	
82,0	46,2	72,8	14 600	14 400	13 800	14 600	14 500	14 500			82,0	
84,0	44,6	70,5	14 200	13 600	13 000	14 400	14 300	14 300			84,0	
88,0	41,1	65,4	12 300	11 800	11 300	14 000	13 900	13 900			88,0	
92,0	37,3	59,5	10 600	10 100	9 700	13 600	13 600	13 600			92,0	
96,0	33,0	52,6	9 000	8 600	8 200	13 400	13 300	13 300			96,0	
100,0											100,0	
104,0											104,0	

# MLC300 VPC-MAX S-2

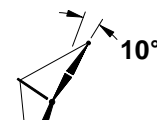
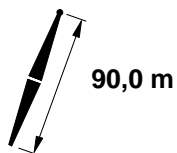

m	°	m	10,6 m			14,6 m			m			
			0°			1°				2°		
			kg	kg	kg	kg	kg	kg		kg	kg	kg
18,3	84,3	115,0	33 000			33 000				18,3		
20,0	83,4	114,7	32 600	27 600		32 600	27 600			20,0		
22,0	82,4	114,3	32 100	27 300	23 100	32 100	27 300	23 100		22,0		
24,0	81,4	114,0	31 700	27 000	23 100	31 700	27 000	23 100		24,0		
26,0	80,3	113,5	31 200	26 600	23 100	31 200	26 600	23 100		26,0		
28,0	79,3	113,1	30 800	26 400	23 100	30 800	26 400	23 100		28,0		
30,0	78,3	112,6	30 400	26 100	23 000	30 400	26 100	23 000		30,0		
32,0	77,2	112,0	30 000	25 800	22 700	30 000	25 800	22 700		32,0		
34,0	76,2	111,5	29 600	25 500	22 500	29 600	25 500	22 500		34,0		
36,0	75,1	110,9	29 200	25 200	22 300	29 200	25 200	22 300		36,0		
38,0	74,1	110,2	28 700	24 900	22 100	28 700	24 900	22 100		38,0		
40,0	73,0	109,5	28 400	24 600	21 900	28 400	24 600	21 900		40,0		
42,0	71,9	108,8	28 000	24 400	21 700	28 000	24 400	21 700		42,0		
44,0	70,9	108,0	27 700	24 100	21 500	27 700	24 100	21 500		44,0		
46,0	69,8	107,2	27 300	23 900	21 300	27 300	23 900	21 300		46,0		
48,0	68,7	106,3	26 900	23 600	21 100	26 900	23 600	21 100		48,0		
50,0	67,6	105,4	26 500	23 400	20 900	26 500	23 400	20 900		50,0		
52,0	66,4	104,4	26 200	23 000	20 700	26 200	23 000	20 700		52,0		
54,0	65,3	103,4	25 600	22 400	20 500	25 600	22 400	20 500		54,0		
56,0	64,2	102,3	24 900	21 800	20 400	24 900	21 800	20 400		56,0		
58,0	63,0	101,2	24 300	21 300	20 200	24 300	21 300	20 200		58,0		
60,0	61,9	100,1	23 700	20 700	19 700	23 700	20 700	19 700		60,0		
62,0	60,7	98,8	23 100	20 200	19 300	23 100	20 200	19 300		62,0		
64,0	59,5	97,6	22 500	19 700	18 900	22 500	19 700	18 900		64,0		
66,0	58,3	96,2	22 000	19 300	18 500	22 000	19 300	18 500		66,0		
68,0	57,1	94,8	21 500	18 900	18 100	21 500	18 900	18 100		68,0		
70,0	55,8	93,3	21 000	18 500	17 700	21 000	18 500	17 700		70,0		
72,0	54,5	91,8	19 800	18 100	17 400	20 500	18 100	17 400		72,0		
74,0	53,3	90,2	18 600	17 500	16 700	20 100	17 800	17 000		74,0		
76,0	51,9	88,5	17 400	16 500	15 700	19 700	17 400	16 700		76,0		
78,0	50,6	86,7	16 300	15 500	14 700	19 300	17 100	16 400		78,0		
80,0	49,2	84,9	15 300	14 500	13 800	18 900	16 800	16 200		80,0		
82,0	47,8	82,9	14 300	13 500	12 800	18 500	16 500	15 900		82,0		
84,0	46,4	80,9	13 300	12 600	12 000	18 200	16 300	15 700		84,0		
88,0	43,4	76,5	11 500	10 900	10 400	17 500	15 900	15 300		88,0		
92,0	40,2	71,6	9 900	9 400	8 900	16 900	15 500	14 900		92,0		
96,0	36,8	66,0	8 400	8 000	7 500	16 400	15 300	14 700		96,0		
100,0	33,0	59,6	7 000	6 600	6 300	15 200	14 600	14 100		100,0		
104,0	28,7	52,2	5 700	5 400	5 100	13 800	13 300	12 900		104,0		
108,0	23,7	43,0	4 400	4 200	3 900	12 500	12 100	11 700		108,0		

# MLC300 VPC-MAX S-2



148  
+  
B60

175 100 kg

360°

90,0 m

24,0 m

20°

m	°	m	10,6 m			14,6 m			m			
			0°			1°				2°		
			kg	kg	kg	kg	kg	kg		kg	kg	
18,3									18,3			
20,0									20,0			
22,0	84,3	113,4	28 700			28 700			22,0			
24,0	83,2	113,0	28 400	24 600		28 400	24 600		24,0			
26,0	82,2	112,6	28 100	24 400	20 500	28 100	24 400	20 500	26,0			
28,0	81,1	112,1	27 600	24 100	20 500	27 600	24 100	20 500	28,0			
30,0	80,1	111,6	26 700	23 900	20 500	26 700	23 900	20 500	30,0			
32,0	79,0	111,1	25 900	23 700	20 500	25 900	23 700	20 500	32,0			
34,0	78,0	110,5	25 200	23 500	20 500	25 200	23 500	20 500	34,0			
36,0	76,9	109,9	24 500	23 300	20 500	24 500	23 300	20 500	36,0			
38,0	75,9	109,2	23 800	23 200	20 500	23 800	23 200	20 500	38,0			
40,0	74,8	108,5	23 100	22 900	20 500	23 100	22 900	20 500	40,0			
42,0	73,7	107,8	22 600	22 400	20 400	22 600	22 400	20 400	42,0			
44,0	72,6	107,0	22 000	21 800	20 300	22 000	21 800	20 300	44,0			
46,0	71,5	106,1	21 500	21 300	20 200	21 500	21 300	20 200	46,0			
48,0	70,4	105,3	20 900	20 800	20 100	20 900	20 800	20 100	48,0			
50,0	69,3	104,3	20 500	20 300	19 900	20 500	20 300	19 900	50,0			
52,0	68,2	103,4	20 000	19 900	19 800	20 000	19 900	19 800	52,0			
54,0	67,0	102,3	19 500	19 400	19 300	19 500	19 400	19 300	54,0			
56,0	65,9	101,3	19 100	19 000	18 900	19 100	19 000	18 900	56,0			
58,0	64,7	100,2	18 700	18 600	18 500	18 700	18 600	18 500	58,0			
60,0	63,5	99,0	18 300	18 200	18 200	18 300	18 200	18 200	60,0			
62,0	62,4	97,7	18 000	17 900	17 800	18 000	17 900	17 800	62,0			
64,0	61,1	96,4	17 600	17 500	17 500	17 600	17 500	17 500	64,0			
66,0	59,9	95,1	17 300	17 200	17 100	17 300	17 200	17 100	66,0			
68,0	58,7	93,7	17 000	16 900	16 800	17 000	16 900	16 800	68,0			
70,0	57,4	92,2	16 700	16 600	16 500	16 700	16 600	16 500	70,0			
72,0	56,1	90,6	16 400	16 300	16 200	16 400	16 300	16 200	72,0			
74,0	54,8	89,0	16 100	16 000	16 000	16 100	16 000	16 000	74,0			
76,0	53,5	87,3	15 800	15 800	15 700	15 800	15 800	15 700	76,0			
78,0	52,1	85,5	15 600	15 500	15 100	15 600	15 500	15 500	78,0			
80,0	50,7	83,6	15 300	15 000	14 300	15 300	15 300	15 200	80,0			
82,0	49,3	81,6	14 800	14 100	13 400	15 100	15 100	15 000	82,0			
84,0	47,9	79,5	13 900	13 200	12 500	14 900	14 800	14 800	84,0			
88,0	44,8	75,0	12 000	11 400	10 800	14 500	14 500	14 400	88,0			
92,0	41,5	70,0	10 300	9 800	9 300	14 100	14 100	14 000	92,0			
96,0	38,0	64,3	8 700	8 300	7 900	13 800	13 800	13 700	96,0			
100,0	34,1	57,8	7 300	6 900	6 500	13 500	13 500	13 500	100,0			
104,0	29,7	50,0	5 900			13 300			104,0			
108,0									108,0			

# MLC300 VPC-MAX S-2

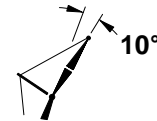
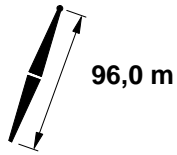
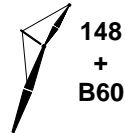

m	°	m	10,6 m			14,6 m			m			
			0°			1°				2°		
			kg	kg	kg	kg	kg	kg		kg	kg	kg
18,3	84,6	121,0	32 500			32 500				18,3		
20,0	83,7	120,8	32 100	26 700		32 100	26 700			20,0		
22,0	82,8	120,4	31 700	26 700		31 700	26 700			22,0		
24,0	81,8	120,1	31 400	26 600	19 600	31 400	26 600	19 600		24,0		
26,0	80,8	119,7	31 000	26 300	19 600	31 000	26 300	19 600		26,0		
28,0	79,8	119,2	30 600	26 000	19 600	30 600	26 000	19 600		28,0		
30,0	78,9	118,8	30 200	25 800	19 600	30 200	25 800	19 600		30,0		
32,0	77,9	118,3	29 800	25 500	19 600	29 800	25 500	19 600		32,0		
34,0	76,9	117,7	29 400	25 300	19 600	29 400	25 300	19 600		34,0		
36,0	75,9	117,1	29 100	25 000	19 600	29 100	25 000	19 600		36,0		
38,0	74,9	116,5	28 700	24 700	19 600	28 700	24 700	19 600		38,0		
40,0	73,9	115,9	28 400	24 500	19 600	28 400	24 500	19 600		40,0		
42,0	72,9	115,2	28 000	24 300	19 600	28 000	24 300	19 600		42,0		
44,0	71,9	114,4	27 700	24 000	19 600	27 700	24 000	19 600		44,0		
46,0	70,8	113,6	27 400	23 800	19 600	27 400	23 800	19 600		46,0		
48,0	69,8	112,8	27 100	23 600	19 600	27 100	23 600	19 600		48,0		
50,0	68,8	112,0	26 700	23 300	19 600	26 700	23 300	19 600		50,0		
52,0	67,7	111,1	26 400	23 100	19 600	26 400	23 100	19 600		52,0		
54,0	66,7	110,1	26 100	22 900	19 600	26 100	22 900	19 600		54,0		
56,0	65,6	109,1	25 700	22 700	19 600	25 700	22 700	19 600		56,0		
58,0	64,5	108,1	25 200	22 500	19 600	25 200	22 500	19 600		58,0		
60,0	63,4	107,0	24 500	22 300	19 600	24 500	22 300	19 600		60,0		
62,0	62,3	105,8	23 900	22 000	19 600	23 900	22 000	19 600		62,0		
64,0	61,2	104,7	23 400	21 600	19 600	23 400	21 600	19 600		64,0		
66,0	60,1	103,4	22 700	21 100	19 500	22 800	21 200	19 500		66,0		
68,0	59,0	102,1	21 400	20 200	18 900	22 300	20 700	19 400		68,0		
70,0	57,8	100,7	20 100	18 900	17 800	21 800	20 300	19 300		70,0		
72,0	56,6	99,3	18 800	17 700	16 700	21 300	19 900	19 000		72,0		
74,0	55,4	97,8	17 600	16 500	15 600	20 900	19 500	18 700		74,0		
76,0	54,2	96,3	16 400	15 400	14 500	20 500	19 200	18 300		76,0		
78,0	53,0	94,7	15 300	14 400	13 500	20 000	18 900	18 000		78,0		
80,0	51,8	93,0	14 200	13 400	12 600	19 700	18 600	17 700		80,0		
82,0	50,5	91,2	13 200	12 400	11 700	19 300	18 200	17 500		82,0		
84,0	49,2	89,4	12 300	11 600	10 800	18 900	18 000	17 200		84,0		
88,0	46,5	85,4	10 500	9 900	9 200	18 200	17 500	16 800		88,0		
92,0	43,7	81,0	8 900	8 300	7 800	17 500	16 800	16 100		92,0		
96,0	40,7	76,2	7 400	6 900	6 400	16 000	15 300	14 600		96,0		
100,0	37,5	70,8	6 000	5 500	5 100	14 500	13 900	13 300		100,0		
104,0	34,0	64,6	4 700	4 300	3 900	13 100	12 600	12 000		104,0		
108,0	30,1	57,6	3 500			11 800	11 300	10 900		108,0		
112,0	25,6	49,1				10 600	10 200	9 800		112,0		

# MLC300 VPC-MAX S-2



148  
+  
B60

175 100 kg

360°

96,0 m

24,0 m

20°

m	°	m	10,6 m			14,6 m			m			
			0°			1°				2°		
			kg	kg	kg	kg	kg	kg		kg	kg	kg
18,3										18,3		
20,0										20,0		
22,0	84,5	119,5	28 400			28 400				22,0		
24,0	83,6	119,1	28 100			28 100				24,0		
26,0	82,6	118,7	27 800	24 000	17 400	27 800	24 000	17 400		26,0		
28,0	81,6	118,3	27 600	23 900	17 400	27 600	23 900	17 400		28,0		
30,0	80,6	117,8	27 100	23 700	17 400	27 100	23 700	17 400		30,0		
32,0	79,6	117,3	26 400	23 500	17 400	26 400	23 500	17 400		32,0		
34,0	78,6	116,7	25 600	23 400	17 400	25 600	23 400	17 400		34,0		
36,0	77,6	116,1	24 900	23 200	17 400	24 900	23 200	17 400		36,0		
38,0	76,6	115,5	24 300	23 000	17 400	24 300	23 000	17 400		38,0		
40,0	75,6	114,9	23 600	22 800	17 400	23 600	22 800	17 400		40,0		
42,0	74,6	114,2	23 000	22 700	17 400	23 000	22 700	17 400		42,0		
44,0	73,5	113,4	22 500	22 300	17 400	22 500	22 300	17 400		44,0		
46,0	72,5	112,6	22 000	21 800	17 400	22 000	21 800	17 400		46,0		
48,0	71,5	111,8	21 400	21 300	17 400	21 400	21 300	17 400		48,0		
50,0	70,4	110,9	20 900	20 800	17 400	20 900	20 800	17 400		50,0		
52,0	69,4	110,0	20 500	20 300	17 400	20 500	20 300	17 400		52,0		
54,0	68,3	109,1	20 100	19 900	17 400	20 100	19 900	17 400		54,0		
56,0	67,2	108,1	19 600	19 500	17 400	19 600	19 500	17 400		56,0		
58,0	66,1	107,0	19 200	19 100	17 400	19 200	19 100	17 400		58,0		
60,0	65,0	105,9	18 900	18 700	17 400	18 900	18 700	17 400		60,0		
62,0	63,9	104,7	18 500	18 400	17 400	18 500	18 400	17 400		62,0		
64,0	62,8	103,5	18 100	18 000	17 400	18 100	18 000	17 400		64,0		
66,0	61,7	102,3	17 800	17 700	17 400	17 800	17 700	17 400		66,0		
68,0	60,5	101,0	17 500	17 400	17 300	17 500	17 400	17 300		68,0		
70,0	59,3	99,6	17 200	17 100	17 000	17 200	17 100	17 000		70,0		
72,0	58,2	98,2	16 900	16 800	16 700	16 900	16 800	16 700		72,0		
74,0	57,0	96,6	16 600	16 500	16 100	16 600	16 500	16 400		74,0		
76,0	55,7	95,1	16 300	16 100	15 200	16 300	16 200	16 200		76,0		
78,0	54,5	93,4	16 000	15 100	14 200	16 100	16 000	15 900		78,0		
80,0	53,2	91,7	14 900	14 100	13 300	15 800	15 700	15 700		80,0		
82,0	51,9	89,9	13 900	13 100	12 300	15 600	15 500	15 400		82,0		
84,0	50,6	88,1	12 900	12 200	11 400	15 400	15 300	15 200		84,0		
88,0	47,9	84,0	11 100	10 400	9 800	14 900	14 900	14 800		88,0		
92,0	45,0	79,6	9 400	8 800	8 200	14 500	14 500	14 400		92,0		
96,0	41,9	74,6	7 800	7 300	6 800	14 200	14 100	14 100		96,0		
100,0	38,7	69,1	6 300	5 900	5 500	13 900	13 800	13 500		100,0		
104,0	35,1	62,8	5 000	4 600	4 200	13 300	12 800	12 300		104,0		
108,0	31,0	55,5	3 700			11 900	11 500	11 000		108,0		
112,0										112,0		



# MLC300 VPC-MAX S-2

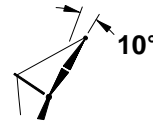
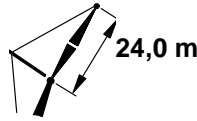
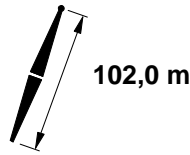

m	°	m	10,6 m		14,6 m		m
			0°		1°		
			kg	kg	kg	kg	
18,3	84,8	127,1	31 600		31 600		18,3
20,0	84,0	126,8	31 300		31 300		20,0
22,0	83,1	126,5	31 000	22 300	31 000	22 300	22,0
24,0	82,2	126,1	30 600	22 300	30 600	22 300	24,0
26,0	81,3	125,8	30 300	22 300	30 300	22 300	26,0
28,0	80,3	125,3	29 900	22 300	29 900	22 300	28,0
30,0	79,4	124,9	29 600	22 300	29 600	22 300	30,0
32,0	78,5	124,4	29 300	22 300	29 300	22 300	32,0
34,0	77,5	123,9	29 000	22 300	29 000	22 300	34,0
36,0	76,6	123,4	28 600	22 300	28 600	22 300	36,0
38,0	75,6	122,8	28 300	22 300	28 300	22 300	38,0
40,0	74,7	122,1	28 000	22 300	28 000	22 300	40,0
42,0	73,7	121,5	27 400	22 300	27 400	22 300	42,0
44,0	72,8	120,8	26 600	22 300	26 600	22 300	44,0
46,0	71,8	120,1	25 800	22 200	25 800	22 200	46,0
48,0	70,8	119,3	25 000	21 700	25 000	21 700	48,0
50,0	69,8	118,5	24 300	21 100	24 300	21 100	50,0
52,0	68,8	117,6	23 600	20 500	23 600	20 500	52,0
54,0	67,9	116,7	22 900	20 000	22 900	20 000	54,0
56,0	66,8	115,8	22 300	19 400	22 300	19 400	56,0
58,0	65,8	114,8	21 700	18 900	21 700	18 900	58,0
60,0	64,8	113,8	21 100	18 400	21 100	18 400	60,0
62,0	63,8	112,7	20 600	17 900	20 600	17 900	62,0
64,0	62,7	111,6	20 000	17 500	20 000	17 500	64,0
66,0	61,7	110,4	19 500	17 000	19 500	17 000	66,0
68,0	60,6	109,2	19 000	16 600	19 000	16 600	68,0
70,0	59,5	107,9	18 600	16 200	18 600	16 200	70,0
72,0	58,5	106,6	18 100	15 900	18 100	15 900	72,0
74,0	57,3	105,2	17 100	15 400	17 700	15 500	74,0
76,0	56,2	103,8	15 900	14 800	17 300	15 200	76,0
78,0	55,1	102,3	14 800	13 900	17 000	14 800	78,0
80,0	53,9	100,7	13 800	12 900	16 600	14 500	80,0
82,0	52,8	99,1	12 800	11 900	16 300	14 200	82,0
84,0	51,6	97,4	11 800	11 000	15 900	13 900	84,0
88,0	49,1	93,8	10 000	9 300	15 300	13 400	88,0
92,0	46,6	89,8	8 400	7 800	14 800	12 900	92,0
96,0	43,9	85,5	6 900	6 400	14 300	12 500	96,0
100,0	41,1	80,8	5 500	5 100	13 900	12 100	100,0
104,0	38,0	75,5	4 300	3 800	12 800	11 800	104,0
108,0	34,8	69,5	3 100		11 500	11 000	108,0
112,0	31,2	62,7			10 300	9 800	112,0
116,0	27,1	54,8			9 200	8 800	116,0
120,0	22,3	45,0			8 100	7 800	120,0

# MLC300 VPC-MAX S-2

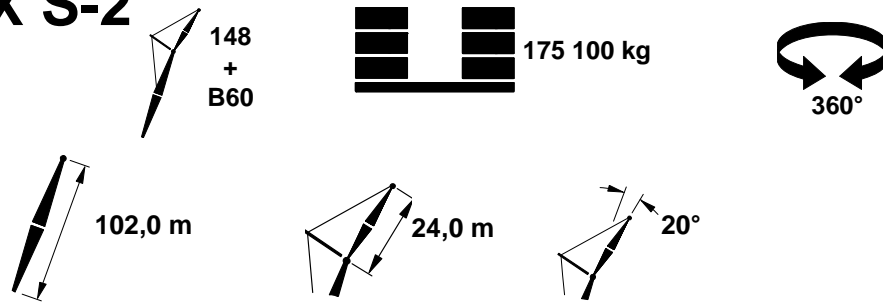

m	°	m	10,6 m		14,6 m		m
			0°		1°		
			kg	kg	kg	kg	
18,3							18,3
20,0							20,0
22,0							22,0
24,0	83,9	125,2	27 600		27 600		24,0
26,0	82,9	124,8	27 400	20 200	27 400	20 200	26,0
28,0	82,0	124,4	27 200	20 200	27 200	20 200	28,0
30,0	81,1	123,9	26 900	20 200	26 900	20 200	30,0
32,0	80,1	123,4	26 400	20 200	26 400	20 200	32,0
34,0	79,2	122,9	25 700	20 200	25 700	20 200	34,0
36,0	78,2	122,4	25 000	20 200	25 000	20 200	36,0
38,0	77,3	121,8	24 400	20 200	24 400	20 200	38,0
40,0	76,3	121,1	23 800	20 200	23 800	20 200	40,0
42,0	75,3	120,5	23 200	20 200	23 200	20 200	42,0
44,0	74,4	119,8	22 700	20 200	22 700	20 200	44,0
46,0	73,4	119,0	22 200	20 000	22 200	20 000	46,0
48,0	72,4	118,2	21 700	19 500	21 700	19 500	48,0
50,0	71,4	117,4	21 200	19 000	21 200	19 000	50,0
52,0	70,4	116,6	20 700	18 600	20 700	18 600	52,0
54,0	69,4	115,7	20 300	18 100	20 300	18 100	54,0
56,0	68,4	114,7	19 900	17 700	19 900	17 700	56,0
58,0	67,4	113,7	19 500	17 200	19 500	17 200	58,0
60,0	66,3	112,7	19 100	16 800	19 100	16 800	60,0
62,0	65,3	111,6	18 800	16 500	18 800	16 500	62,0
64,0	64,3	110,5	18 400	16 100	18 400	16 100	64,0
66,0	63,2	109,3	18 000	15 700	18 000	15 700	66,0
68,0	62,1	108,1	17 600	15 400	17 600	15 400	68,0
70,0	61,0	106,8	17 200	15 000	17 200	15 000	70,0
72,0	59,9	105,4	16 800	14 700	16 800	14 700	72,0
74,0	58,8	104,1	16 500	14 400	16 500	14 400	74,0
76,0	57,7	102,6	16 100	14 200	16 100	14 200	76,0
78,0	56,5	101,1	15 600	13 900	15 800	13 900	78,0
80,0	55,4	99,5	14 500	13 400	15 500	13 600	80,0
82,0	54,2	97,9	13 500	12 600	15 300	13 400	82,0
84,0	53,0	96,1	12 500	11 700	15 000	13 100	84,0
88,0	50,5	92,5	10 600	9 900	14 500	12 700	88,0
92,0	47,9	88,5	9 000	8 300	14 000	12 300	92,0
96,0	45,2	84,1	7 400	6 800	13 600	11 900	96,0
100,0	42,3	79,2	6 000	5 500	13 300	11 600	100,0
104,0	39,2	73,8	4 600	4 200	12 900	11 400	104,0
108,0	35,8	67,7	3 300		11 700	11 000	108,0
112,0	32,2	60,7			10 500	10 000	112,0
116,0							116,0
120,0							120,0

# MLC300 VPC-MAX S-2



108,0 m



24,0 m

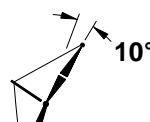

10°

m	°	m	10,6 m		14,6 m		m
			0°		1°		
			kg	kg	kg	kg	
19,8	84,4	132,9	30 700	30 700	30 700	30 700	19,8
20,0	84,3	132,9	30 700	30 700	30 700	30 700	20,0
22,0	83,4	132,6	30 400	18 800	30 400	18 800	22,0
24,0	82,5	132,2	30 100	18 800	30 100	18 800	24,0
26,0	81,7	131,9	29 800	18 800	29 800	18 800	26,0
28,0	80,8	131,5	29 500	18 800	29 500	18 800	28,0
30,0	79,9	131,1	29 200	18 800	29 200	18 800	30,0
32,0	79,0	130,6	28 900	18 800	28 900	18 800	32,0
34,0	78,1	130,1	28 600	18 800	28 600	18 800	34,0
36,0	77,2	129,6	28 300	18 800	28 300	18 800	36,0
38,0	76,3	129,0	28 000	18 800	28 000	18 800	38,0
40,0	75,4	128,4	27 700	18 800	27 700	18 800	40,0
42,0	74,5	127,8	26 800	18 800	26 800	18 800	42,0
44,0	73,6	127,1	25 900	18 800	25 900	18 800	44,0
46,0	72,7	126,4	25 100	18 800	25 100	18 800	46,0
48,0	71,7	125,7	24 200	18 800	24 200	18 800	48,0
50,0	70,8	124,9	23 500	18 800	23 500	18 800	50,0
52,0	69,9	124,1	22 700	18 800	22 700	18 800	52,0
54,0	68,9	123,3	22 000	18 600	22 000	18 600	54,0
56,0	68,0	122,4	21 400	18 200	21 400	18 200	56,0
58,0	67,0	121,5	20 700	17 600	20 700	17 600	58,0
60,0	66,1	120,5	20 100	17 100	20 100	17 100	60,0
62,0	65,1	119,5	19 600	16 600	19 600	16 600	62,0
64,0	64,1	118,4	19 000	16 200	19 000	16 200	64,0
66,0	63,1	117,3	18 500	15 700	18 500	15 700	66,0
68,0	62,1	116,2	18 000	15 300	18 000	15 300	68,0
70,0	61,1	115,0	17 500	14 900	17 500	14 900	70,0
72,0	60,1	113,8	17 000	14 500	17 000	14 500	72,0
74,0	59,0	112,5	16 100	14 100	16 600	14 100	74,0
76,0	58,0	111,1	14 900	13 700	16 200	13 800	76,0
78,0	56,9	109,7	13 800	12 800	15 800	13 400	78,0
80,0	55,9	108,3	12 800	11 800	15 400	13 100	80,0
82,0	54,8	106,8	11 800	10 800	15 000	12 800	82,0
84,0	53,7	105,2	10 800	10 000	14 700	12 500	84,0
88,0	51,4	101,9	9 000	8 300	14 100	12 000	88,0
92,0	49,1	98,3	7 400	6 700	13 500	11 500	92,0
96,0	46,6	94,3	5 900	5 300	13 000	11 100	96,0
100,0	44,1	90,1	4 500	4 000	12 600	10 700	100,0
104,0	41,4	85,4	3 300		12 000	10 400	104,0
108,0	38,6	80,2			10 800	10 000	108,0
112,0	35,5	74,4			9 600	9 100	112,0
116,0	32,2	67,9			8 500	8 000	116,0
120,0	28,5	60,3			7 400	7 000	120,0
124,0	24,2	51,4			6 400	6 100	124,0
128,0	19,0	39,9			5 500	5 200	128,0



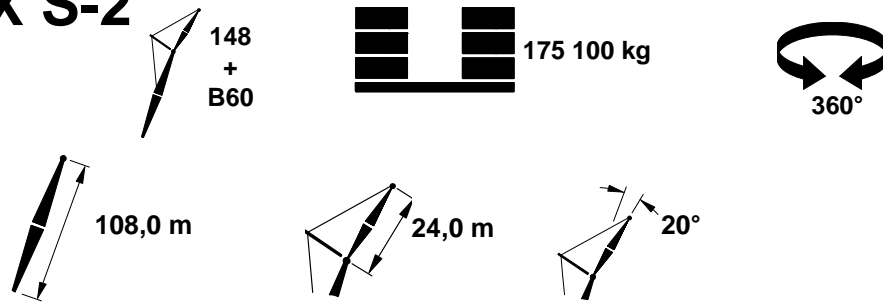

# MLC300 VPC-MAX S-2

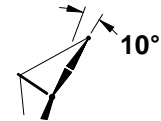
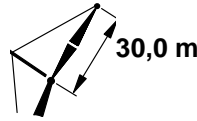
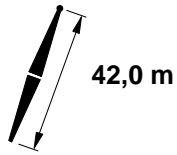

m	°	m	10,6 m		14,6 m		m
			0°		1°		
			kg	kg	kg	kg	
19,8							19,8
20,0							20,0
22,0							22,0
24,0							24,0
26,0	84,2	131,3	27 200		27 200		26,0
28,0	82,4	130,5	26 800	17 200	26 800	17 200	28,0
30,0	81,5	130,1	26 600	17 200	26 600	17 200	30,0
32,0	80,6	129,6	26 400	17 200	26 400	17 200	32,0
34,0	79,7	129,1	26 000	17 200	26 000	17 200	34,0
36,0	78,8	128,6	25 300	17 200	25 300	17 200	36,0
38,0	77,9	128,0	24 700	17 200	24 700	17 200	38,0
40,0	77,0	127,4	24 100	17 200	24 100	17 200	40,0
42,0	76,0	126,8	23 500	17 200	23 500	17 200	42,0
44,0	75,1	126,1	23 000	17 200	23 000	17 200	44,0
46,0	74,2	125,4	22 500	17 200	22 500	17 200	46,0
48,0	73,3	124,7	22 000	17 200	22 000	17 200	48,0
50,0	72,3	123,9	21 500	17 200	21 500	17 200	50,0
52,0	71,4	123,1	20 800	17 200	20 800	17 200	52,0
54,0	70,4	122,2	20 300	17 100	20 300	17 100	54,0
56,0	69,5	121,3	19 700	16 800	19 700	16 800	56,0
58,0	68,5	120,4	19 200	16 300	19 200	16 300	58,0
60,0	67,5	119,4	18 700	15 900	18 700	15 900	60,0
62,0	66,6	118,4	18 200	15 500	18 200	15 500	62,0
64,0	65,6	117,3	17 700	15 100	17 700	15 100	64,0
66,0	64,6	116,2	17 200	14 700	17 200	14 700	66,0
68,0	63,6	115,1	16 800	14 300	16 800	14 300	68,0
70,0	62,5	113,9	16 400	14 000	16 400	14 000	70,0
72,0	61,5	112,6	16 000	13 700	16 000	13 700	72,0
74,0	60,5	111,3	15 600	13 300	15 600	13 300	74,0
76,0	59,4	110,0	15 300	13 000	15 300	13 000	76,0
78,0	58,3	108,6	14 600	12 700	14 900	12 700	78,0
80,0	57,2	107,1	13 600	12 300	14 600	12 400	80,0
82,0	56,1	105,6	12 500	11 500	14 300	12 200	82,0
84,0	55,0	104,0	11 500	10 700	14 000	11 900	84,0
88,0	52,7	100,6	9 700	8 900	13 400	11 400	88,0
92,0	50,4	96,9	8 000	7 300	12 900	11 000	92,0
96,0	47,9	92,9	6 500	5 800	12 500	10 600	96,0
100,0	45,3	88,6	5 000	4 500	12 100	10 300	100,0
104,0	42,6	83,8	3 700		11 800	10 000	104,0
108,0	39,7	78,5			11 000	9 800	108,0
112,0	36,6	72,6			9 800	9 200	112,0
116,0	33,1	65,9			8 600	8 200	116,0
120,0	29,3	58,1			7 500		120,0
124,0							124,0
128,0							128,0

# MLC300 VPC-MAX S-2



			 10,6 m			 14,6 m					
			 0°			 1°			 2°		
			kg	kg	kg	kg	kg	kg			
16,8	82,5	72,7	28 900 <sup>b</sup>	24 400 <sup>c</sup>		28 900 <sup>b</sup>	24 400 <sup>c</sup>		16,8		
18,0	81,5	72,4	28 400	24 000 <sup>c</sup>		28 400	24 000 <sup>c</sup>		18,0		
20,0	79,8	71,9	27 500	23 400 <sup>b</sup>	20 400 <sup>c</sup>	27 500	23 400 <sup>b</sup>	20 400 <sup>c</sup>	20,0		
22,0	78,2	71,4	26 600	22 800	19 900 <sup>c</sup>	26 600	22 800	19 900 <sup>c</sup>	22,0		
24,0	76,5	70,7	25 700	22 200	19 500	25 700	22 200	19 500	24,0		
26,0	74,8	70,1	24 800	21 700	19 000	24 800	21 700	19 000	26,0		
28,0	73,1	69,3	23 900	21 100	18 600	23 900	21 100	18 600	28,0		
30,0	71,4	68,5	23 100	20 600	18 200	23 100	20 600	18 200	30,0		
32,0	69,7	67,6	22 300	20 000	17 800	22 300	20 000	17 800	32,0		
34,0	67,9	66,6	21 600	19 400	17 400	21 600	19 400	17 400	34,0		
36,0	66,1	65,6	20 900	18 900	17 100	20 900	18 900	17 100	36,0		
38,0	64,3	64,4	20 200	18 400	16 700	20 200	18 400	16 700	38,0		
40,0	62,4	63,2	19 400	17 800	16 300	19 400	17 800	16 300	40,0		
42,0	60,5	61,9	18 500	17 400	15 900	18 500	17 400	15 900	42,0		
44,0	58,6	60,5	17 700	16 900	15 600	17 700	16 900	15 600	44,0		
46,0	56,6	59,0	17 000	16 500	15 200	17 000	16 500	15 200	46,0		
48,0	54,6	57,4	16 300	16 000	14 800	16 300	16 000	14 800	48,0		
50,0	52,5	55,6	15 700	15 500	14 500	15 700	15 500	14 500	50,0		
52,0	50,3	53,7	15 100	14 900	14 100	15 100	14 900	14 100	52,0		
54,0	48,0	51,7	14 500	14 400	13 800	14 500	14 400	13 800	54,0		
56,0	45,6	49,5	14 000	13 900	13 600	14 000	13 900	13 600	56,0		
58,0	43,2	47,1	13 500	13 400	13 300	13 500	13 400	13 300	58,0		
60,0	40,5	44,5	13 100	13 000	12 900	13 100	13 000	12 900	60,0		
62,0	37,7	41,5	12 700	12 600	12 500	12 700	12 600	12 500	62,0		
64,0	34,7	38,3	12 300	12 200	12 100	12 300	12 200	12 100	64,0		
66,0	31,3	34,6	11 900	11 800	11 800	11 900	11 800	11 800	66,0		
68,0	27,6	30,3	11 600	11 500	11 400	11 600	11 500	11 400	68,0		
70,0	23,0	24,9	11 300	11 200	11 100	11 300	11 200	11 100	70,0		



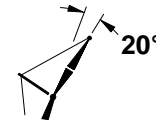
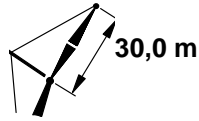
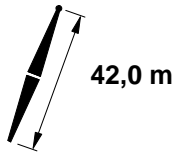
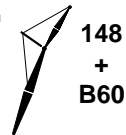



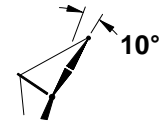
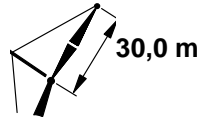
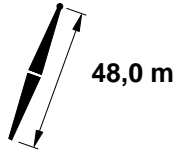
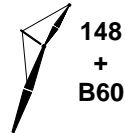

# MLC300 VPC-MAX S-2

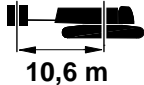
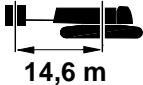
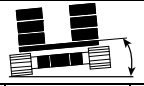
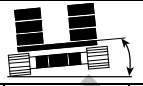
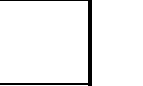
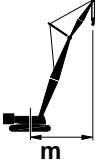
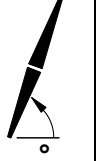
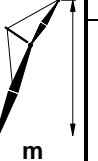

m	°	m	10,6 m			14,6 m			m			
			0°			1°				2°		
			kg	kg	kg	kg	kg	kg		kg	kg	kg
16,8											16,8	
18,0											18,0	
20,0											20,0	
22,0	81,9	70,6	23 400 <sup>b</sup>	20 800 <sup>c</sup>		23 400 <sup>b</sup>	20 800 <sup>c</sup>				22,0	
24,0	80,2	69,9	22 200	20 300		22 200	20 300				24,0	
26,0	78,5	69,2	21 000	19 800		21 000	19 800				26,0	
28,0	76,8	68,5	19 900	19 300	17 700 <sup>b</sup>	19 900	19 300	17 700 <sup>b</sup>			28,0	
30,0	75,1	67,6	19 000	18 700	17 400	19 000	18 700	17 400			30,0	
32,0	73,3	66,7	18 100	17 900	16 700	18 100	17 900	16 700			32,0	
34,0	71,5	65,7	17 300	17 100	16 300	17 300	17 100	16 300			34,0	
36,0	69,7	64,7	16 500	16 400	16 000	16 500	16 400	16 000			36,0	
38,0	67,9	63,5	15 800	15 700	15 600	15 800	15 700	15 600			38,0	
40,0	66,0	62,3	15 200	15 100	15 000	15 200	15 100	15 000			40,0	
42,0	64,1	61,0	14 600	14 500	14 400	14 600	14 500	14 400			42,0	
44,0	62,1	59,5	14 100	14 000	13 900	14 100	14 000	13 900			44,0	
46,0	60,1	58,0	13 500	13 500	13 400	13 500	13 500	13 400			46,0	
48,0	58,0	56,4	13 100	13 000	12 900	13 100	13 000	12 900			48,0	
50,0	55,8	54,6	12 600	12 600	12 500	12 600	12 600	12 500			50,0	
52,0	53,6	52,7	12 200	12 200	12 100	12 200	12 200	12 100			52,0	
54,0	51,3	50,6	11 900	11 800	11 700	11 900	11 800	11 700			54,0	
56,0	48,9	48,3	11 500	11 400	11 400	11 500	11 400	11 400			56,0	
58,0	46,3	45,8	11 200	11 100	11 100	11 200	11 100	11 100			58,0	
60,0	43,6	43,1	10 900	10 800	10 800	10 900	10 800	10 800			60,0	
62,0	40,7	40,1	10 600	10 500	10 500	10 600	10 500	10 500			62,0	
64,0	37,5	36,7	10 300	10 300	10 200	10 300	10 300	10 200			64,0	
66,0	34,0	32,8	10 100	10 100	10 000	10 100	10 100	10 000			66,0	
68,0	30,0	28,2	9 900			9 900					68,0	
70,0											70,0	

# MLC300 VPC-MAX S-2



			 10,6 m			 14,6 m			
			 0°			 1°			 2°
 m	 °	 m	 kg	 kg	 kg	 kg	 kg	 kg	 m
15,2	84,2	79,1	29 700b			29 700b			15,2
16,0	83,6	79,0	29 400b			29 400b			16,0
18,0	82,1	78,6	28 500	24 100b		28 500	24 100b		18,0
20,0	80,6	78,1	27 700	23 500	20 400c	27 700	23 500	20 400c	20,0
22,0	79,1	77,6	27 000	23 000	20 000b	27 000	23 000	20 000b	22,0
24,0	77,6	77,0	26 200	22 400	19 600	26 200	22 400	19 600	24,0
26,0	76,0	76,4	25 300	21 900	19 200	25 300	21 900	19 200	26,0
28,0	74,5	75,7	24 500	21 400	18 800	24 500	21 400	18 800	28,0
30,0	72,9	75,0	23 700	20 900	18 400	23 700	20 900	18 400	30,0
32,0	71,3	74,1	23 000	20 400	18 100	23 000	20 400	18 100	32,0
34,0	69,7	73,3	22 300	19 900	17 700	22 300	19 900	17 700	34,0
36,0	68,1	72,3	21 600	19 400	17 400	21 600	19 400	17 400	36,0
38,0	66,5	71,3	21 000	18 900	17 100	21 000	18 900	17 100	38,0
40,0	64,8	70,2	20 400	18 400	16 700	20 400	18 400	16 700	40,0
42,0	63,1	69,0	19 700	18 000	16 400	19 700	18 000	16 400	42,0
44,0	61,4	67,8	18 800	17 500	16 000	18 800	17 500	16 000	44,0
46,0	59,6	66,4	18 100	17 100	15 700	18 100	17 100	15 700	46,0
48,0	57,8	65,0	17 400	16 700	15 400	17 400	16 700	15 400	48,0
50,0	56,0	63,5	16 700	16 300	15 000	16 700	16 300	15 000	50,0
52,0	54,1	61,8	16 100	15 900	14 700	16 100	15 900	14 700	52,0
54,0	52,1	60,1	15 500	15 400	14 400	15 500	15 400	14 400	54,0
56,0	50,1	58,2	15 000	14 900	14 100	15 000	14 900	14 100	56,0
58,0	48,0	56,2	14 500	14 400	13 800	14 500	14 400	13 800	58,0
60,0	45,9	54,0	14 000	13 900	13 600	14 000	13 900	13 600	60,0
62,0	43,6	51,7	13 600	13 500	13 300	13 600	13 500	13 300	62,0
64,0	41,2	49,1	13 200	13 100	13 000	13 200	13 100	13 000	64,0
66,0	38,7	46,3	12 800	12 700	12 600	12 800	12 700	12 600	66,0
68,0	36,0	43,3	12 400	12 300	12 200	12 400	12 300	12 200	68,0
70,0	33,1	39,8	12 100	12 000	11 900	12 100	12 000	11 900	70,0
72,0	29,9	35,9	11 800	11 700	11 600	11 800	11 700	11 600	72,0
74,0	26,3	31,4	11 500	11 400	11 300	11 500	11 400	11 300	74,0
76,0	21,9	25,8	11 200	11 100	11 100	11 200	11 100	11 100	76,0

# MLC300 VPC-MAX S-2

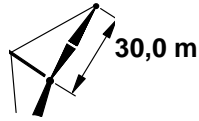
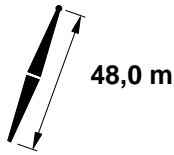

			10,6 m			14,6 m					
			0°			1°			2°		
m	°	m	kg	kg	kg	kg	kg	kg	kg	m	
15,2										15,2	
16,0										16,0	
18,0										18,0	
20,0	84,1	77,3	24 400b			24 400b				20,0	
22,0	82,6	76,7	23 700	20 900b		23 700	20 900b			22,0	
24,0	81,0	76,2	22 800	20 500	18 100b	22 800	20 500	18 100b		24,0	
26,0	79,5	75,5	21 600	20 000	17 800	21 600	20 000	17 800		26,0	
28,0	77,9	74,8	20 600	19 500	17 500	20 600	19 500	17 500		28,0	
30,0	76,3	74,1	19 600	19 100	17 200	19 600	19 100	17 200		30,0	
32,0	74,7	73,2	18 700	18 600	16 900	18 700	18 600	16 900		32,0	
34,0	73,1	72,4	17 900	17 800	16 600	17 900	17 800	16 600		34,0	
36,0	71,4	71,4	17 200	17 100	16 300	17 200	17 100	16 300		36,0	
38,0	69,8	70,4	16 500	16 400	15 900	16 500	16 400	15 900		38,0	
40,0	68,1	69,3	15 900	15 800	15 600	15 900	15 800	15 600		40,0	
42,0	66,4	68,1	15 300	15 200	15 100	15 300	15 200	15 100		42,0	
44,0	64,6	66,8	14 700	14 600	14 600	14 700	14 600	14 600		44,0	
46,0	62,8	65,4	14 200	14 100	14 100	14 200	14 100	14 100		46,0	
48,0	61,0	64,0	13 800	13 700	13 600	13 800	13 700	13 600		48,0	
50,0	59,1	62,4	13 300	13 300	13 200	13 300	13 300	13 200		50,0	
52,0	57,2	60,8	12 900	12 800	12 800	12 900	12 800	12 800		52,0	
54,0	55,2	59,0	12 500	12 400	12 400	12 500	12 400	12 400		54,0	
56,0	53,1	57,1	12 100	12 100	12 000	12 100	12 100	12 000		56,0	
58,0	51,0	55,0	11 800	11 700	11 700	11 800	11 700	11 700		58,0	
60,0	48,8	52,8	11 500	11 400	11 400	11 500	11 400	11 400		60,0	
62,0	46,5	50,4	11 200	11 100	11 100	11 200	11 100	11 100		62,0	
64,0	44,0	47,7	10 900	10 900	10 800	10 900	10 900	10 800		64,0	
66,0	41,4	44,9	10 600	10 600	10 600	10 600	10 600	10 600		66,0	
68,0	38,6	41,7	10 400	10 400	10 300	10 400	10 400	10 300		68,0	
70,0	35,6	38,1	10 200	10 100	10 100	10 200	10 100	10 100		70,0	
72,0	32,2	34,0	10 000	10 000	9 900	10 000	10 000	9 900		72,0	
74,0	28,3	29,1	9 800			9 800				74,0	
76,0										76,0	



# MLC300 VPC-MAX S-2

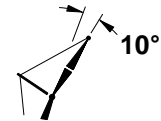
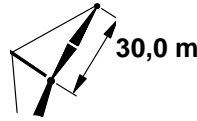
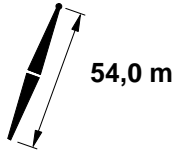

m	°	m	10,6 m			14,6 m			m			
			0°			1°				2°		
			kg	kg	kg	kg	kg	kg		kg	kg	kg
15,2	84,6	85,2	29 700b			29 700b			15,2			
16,0	84,1	85,1	29 400b			29 400b			16,0			
18,0	82,7	84,7	28 600	24 100b		28 600	24 100b		18,0			
20,0	81,3	84,3	27 900	23 500	20 500c	27 900	23 500	20 500c	20,0			
22,0	79,9	83,8	27 200	23 000	20 000b	27 200	23 000	20 000b	22,0			
24,0	78,5	83,3	26 500	22 600	19 700	26 500	22 600	19 700	24,0			
26,0	77,1	82,7	25 800	22 100	19 300	25 800	22 100	19 300	26,0			
28,0	75,7	82,0	25 000	21 600	19 000	25 000	21 600	19 000	28,0			
30,0	74,2	81,3	24 200	21 200	18 600	24 200	21 200	18 600	30,0			
32,0	72,8	80,6	23 500	20 700	18 300	23 500	20 700	18 300	32,0			
34,0	71,3	79,8	22 900	20 300	18 000	22 900	20 300	18 000	34,0			
36,0	69,8	78,9	22 200	19 900	17 700	22 200	19 900	17 700	36,0			
38,0	68,3	78,0	21 600	19 400	17 400	21 600	19 400	17 400	38,0			
40,0	66,8	77,0	21 000	18 900	17 000	21 000	18 900	17 000	40,0			
42,0	65,2	75,9	20 500	18 500	16 700	20 500	18 500	16 700	42,0			
44,0	63,7	74,8	19 900	18 100	16 400	19 900	18 100	16 400	44,0			
46,0	62,1	73,6	19 100	17 600	16 100	19 100	17 600	16 100	46,0			
48,0	60,5	72,3	18 400	17 200	15 800	18 400	17 200	15 800	48,0			
50,0	58,8	70,9	17 700	16 900	15 500	17 700	16 900	15 500	50,0			
52,0	57,1	69,5	17 100	16 500	15 200	17 100	16 500	15 200	52,0			
54,0	55,4	67,9	16 500	16 100	14 900	16 500	16 100	14 900	54,0			
56,0	53,6	66,3	16 000	15 700	14 600	16 000	15 700	14 600	56,0			
58,0	51,8	64,5	15 400	15 300	14 300	15 400	15 300	14 300	58,0			
60,0	50,0	62,7	15 000	14 800	14 100	15 000	14 800	14 100	60,0			
62,0	48,0	60,7	14 500	14 400	13 800	14 500	14 400	13 800	62,0			
64,0	46,0	58,5	14 100	13 900	13 600	14 100	13 900	13 600	64,0			
66,0	44,0	56,2	13 700	13 500	13 300	13 700	13 500	13 300	66,0			
68,0	41,8	53,8	13 300	13 200	13 000	13 300	13 200	13 000	68,0			
70,0	39,5	51,1	12 900	12 800	12 700	12 900	12 800	12 700	70,0			
72,0	37,1	48,1	12 600	12 500	12 400	12 600	12 500	12 400	72,0			
74,0	34,5	44,9	12 200	12 200	12 100	12 200	12 200	12 100	74,0			
76,0	31,7	41,3	11 900	11 900	11 800	11 900	11 900	11 800	76,0			
78,0	28,6	37,3	11 700	11 600	11 500	11 700	11 600	11 500	78,0			
80,0	25,1	32,5	11 400	11 300	11 200	11 400	11 300	11 200	80,0			
82,0	21,0	26,7	11 200	11 100	11 000	11 200	11 100	11 000	82,0			

# MLC300 VPC-MAX S-2

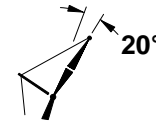
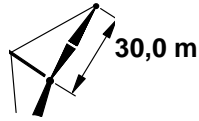
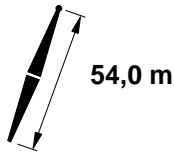
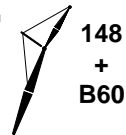

m	°	m	10,6 m			14,6 m			m			
			0°			1°				2°		
			kg	kg	kg	kg	kg	kg		kg	kg	kg
15,2										15,2		
16,0										16,0		
18,0										18,0		
20,0	84,5	83,4	24 500			24 500				20,0		
22,0	83,1	82,9	23 900	20 900b		23 900	20 900b			22,0		
24,0	81,7	82,4	23 200	20 600	18 100b	23 200	20 600	18 100b		24,0		
26,0	80,3	81,8	22 100	20 200	17 900	22 100	20 200	17 900		26,0		
28,0	78,8	81,1	21 100	19 700	17 600	21 100	19 700	17 600		28,0		
30,0	77,4	80,4	20 200	19 300	17 300	20 200	19 300	17 300		30,0		
32,0	75,9	79,7	19 300	18 900	17 000	19 300	18 900	17 000		32,0		
34,0	74,4	78,9	18 500	18 400	16 800	18 500	18 400	16 800		34,0		
36,0	72,9	78,0	17 800	17 700	16 500	17 800	17 700	16 500		36,0		
38,0	71,4	77,0	17 100	17 000	16 200	17 100	17 000	16 200		38,0		
40,0	69,8	76,0	16 500	16 400	15 900	16 500	16 400	15 900		40,0		
42,0	68,3	75,0	15 900	15 800	15 600	15 900	15 800	15 600		42,0		
44,0	66,7	73,8	15 400	15 300	15 200	15 400	15 300	15 200		44,0		
46,0	65,1	72,6	14 900	14 800	14 700	14 900	14 800	14 700		46,0		
48,0	63,4	71,3	14 400	14 300	14 200	14 400	14 300	14 200		48,0		
50,0	61,8	69,9	13 900	13 900	13 800	13 900	13 900	13 800		50,0		
52,0	60,0	68,4	13 500	13 400	13 400	13 500	13 400	13 400		52,0		
54,0	58,3	66,8	13 100	13 000	13 000	13 100	13 000	13 000		54,0		
56,0	56,5	65,2	12 700	12 700	12 600	12 700	12 700	12 600		56,0		
58,0	54,7	63,4	12 400	12 300	12 300	12 400	12 300	12 300		58,0		
60,0	52,8	61,5	12 100	12 000	11 900	12 100	12 000	11 900		60,0		
62,0	50,8	59,4	11 800	11 700	11 600	11 800	11 700	11 600		62,0		
64,0	48,7	57,2	11 500	11 400	11 400	11 500	11 400	11 400		64,0		
66,0	46,6	54,9	11 200	11 100	11 100	11 200	11 100	11 100		66,0		
68,0	44,4	52,3	10 900	10 900	10 800	10 900	10 900	10 800		68,0		
70,0	42,0	49,6	10 700	10 700	10 600	10 700	10 700	10 600		70,0		
72,0	39,5	46,5	10 500	10 400	10 400	10 500	10 400	10 400		72,0		
74,0	36,9	43,2	10 300	10 200	10 200	10 300	10 200	10 200		74,0		
76,0	33,9	39,4	10 100	10 000	10 000	10 100	10 000	10 000		76,0		
78,0	30,7	35,1	9 900	9 900	9 800	9 900	9 900	9 800		78,0		
80,0										80,0		
82,0										82,0		

# MLC300 VPC-MAX S-2

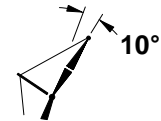
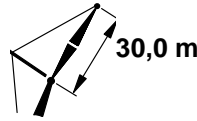
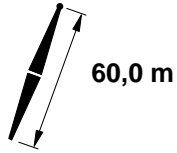

m	°	m	10,6 m			14,6 m			m			
			0°			1°				2°		
			kg	kg	kg	kg	kg	kg		kg	kg	kg
15,2	85,0	91,2	29 600			29 600				15,2		
16,0	84,5	91,1	29 300			29 300				16,0		
18,0	83,2	90,8	28 600	24 000		28 600	24 000			18,0		
20,0	81,9	90,4	27 900	23 500	20 400b	27 900	23 500	20 400b		20,0		
22,0	80,6	89,9	27 300	23 100	20 000	27 300	23 100	20 000		22,0		
24,0	79,3	89,5	26 700	22 600	19 700	26 700	22 600	19 700		24,0		
26,0	78,0	88,9	26 000	22 200	19 400	26 000	22 200	19 400		26,0		
28,0	76,6	88,3	25 400	21 800	19 100	25 400	21 800	19 100		28,0		
30,0	75,3	87,7	24 700	21 400	18 700	24 700	21 400	18 700		30,0		
32,0	74,0	87,0	24 000	21 000	18 400	24 000	21 000	18 400		32,0		
34,0	72,6	86,3	23 400	20 600	18 100	23 400	20 600	18 100		34,0		
36,0	71,2	85,5	22 800	20 200	17 800	22 800	20 200	17 800		36,0		
38,0	69,9	84,6	22 200	19 800	17 500	22 200	19 800	17 500		38,0		
40,0	68,5	83,7	21 600	19 400	17 300	21 600	19 400	17 300		40,0		
42,0	67,0	82,7	21 100	18 900	17 000	21 100	18 900	17 000		42,0		
44,0	65,6	81,7	20 500	18 500	16 700	20 500	18 500	16 700		44,0		
46,0	64,2	80,6	20 000	18 100	16 400	20 000	18 100	16 400		46,0		
48,0	62,7	79,4	19 400	17 700	16 200	19 400	17 700	16 200		48,0		
50,0	61,2	78,2	18 700	17 300	15 900	18 700	17 300	15 900		50,0		
52,0	59,7	76,8	18 100	17 000	15 600	18 100	17 000	15 600		52,0		
54,0	58,1	75,5	17 500	16 700	15 300	17 500	16 700	15 300		54,0		
56,0	56,5	74,0	16 900	16 300	15 000	16 900	16 300	15 000		56,0		
58,0	54,9	72,4	16 400	16 000	14 800	16 400	16 000	14 800		58,0		
60,0	53,3	70,8	15 800	15 600	14 500	15 800	15 600	14 500		60,0		
62,0	51,6	69,0	15 400	15 200	14 300	15 400	15 200	14 300		62,0		
64,0	49,8	67,1	14 900	14 800	14 000	14 900	14 800	14 000		64,0		
66,0	48,1	65,2	14 500	14 400	13 800	14 500	14 400	13 800		66,0		
68,0	46,2	63,0	14 100	14 000	13 600	14 100	14 000	13 600		68,0		
70,0	44,3	60,8	13 700	13 600	13 400	13 700	13 600	13 400		70,0		
72,0	42,3	58,4	13 300	13 200	13 100	13 300	13 200	13 100		72,0		
74,0	40,2	55,8	13 000	12 900	12 800	13 000	12 900	12 800		74,0		
76,0	38,0	52,9	12 700	12 600	12 500	12 700	12 600	12 500		76,0		
78,0	35,7	49,9	12 400	12 300	12 200	12 400	12 300	12 200		78,0		
80,0	33,2	46,5	12 100	12 000	11 900	12 100	12 000	11 900		80,0		
82,0	30,5	42,8	11 800	11 700	11 700	11 800	11 700	11 700		82,0		
84,0	27,5	38,5	11 600	11 500	11 400	11 600	11 500	11 400		84,0		
88,0	20,1	27,6	11 100	11 100	11 000	11 100	11 100	11 000		88,0		

# MLC300 VPC-MAX S-2

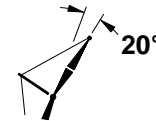
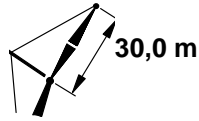
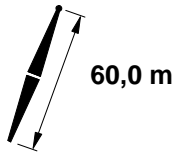
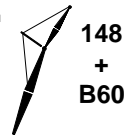

m	°	m	10,6 m			14,6 m			m
			0°	1°	2°	0°	1°	2°	
			kg	kg	kg	kg	kg	kg	
15,2									15,2
16,0									16,0
18,0									18,0
20,0									20,0
22,0	83,6	89,0	24 000			24 000			22,0
24,0	82,3	88,5	23 400	20 600		23 400	20 600		24,0
26,0	80,9	88,0	22 600	20 200	17 900	22 600	20 200	17 900	26,0
28,0	79,6	87,4	21 600	19 900	17 600	21 600	19 900	17 600	28,0
30,0	78,3	86,8	20 700	19 500	17 400	20 700	19 500	17 400	30,0
32,0	76,9	86,1	19 900	19 100	17 100	19 900	19 100	17 100	32,0
34,0	75,5	85,3	19 100	18 700	16 900	19 100	18 700	16 900	34,0
36,0	74,1	84,5	18 400	18 200	16 700	18 400	18 200	16 700	36,0
38,0	72,7	83,6	17 700	17 600	16 400	17 700	17 600	16 400	38,0
40,0	71,3	82,7	17 100	17 000	16 200	17 100	17 000	16 200	40,0
42,0	69,9	81,7	16 500	16 400	15 900	16 500	16 400	15 900	42,0
44,0	68,4	80,7	15 900	15 900	15 600	15 900	15 900	15 600	44,0
46,0	67,0	79,5	15 400	15 300	15 200	15 400	15 300	15 200	46,0
48,0	65,5	78,4	15 000	14 900	14 800	15 000	14 900	14 800	48,0
50,0	64,0	77,1	14 500	14 400	14 300	14 500	14 400	14 300	50,0
52,0	62,4	75,8	14 100	14 000	13 900	14 100	14 000	13 900	52,0
54,0	60,8	74,4	13 700	13 600	13 500	13 700	13 600	13 500	54,0
56,0	59,2	72,9	13 300	13 200	13 200	13 300	13 200	13 200	56,0
58,0	57,6	71,3	13 000	12 900	12 800	13 000	12 900	12 800	58,0
60,0	55,9	69,6	12 600	12 600	12 500	12 600	12 600	12 500	60,0
62,0	54,2	67,8	12 300	12 300	12 200	12 300	12 300	12 200	62,0
64,0	52,4	65,9	12 000	12 000	11 900	12 000	12 000	11 900	64,0
66,0	50,6	63,9	11 700	11 700	11 600	11 700	11 700	11 600	66,0
68,0	48,7	61,7	11 500	11 400	11 300	11 500	11 400	11 300	68,0
70,0	46,7	59,4	11 200	11 100	11 100	11 200	11 100	11 100	70,0
72,0	44,7	56,9	11 000	10 900	10 900	11 000	10 900	10 900	72,0
74,0	42,6	54,2	10 700	10 700	10 600	10 700	10 700	10 600	74,0
76,0	40,3	51,3	10 500	10 500	10 500	10 500	10 500	10 500	76,0
78,0	37,9	48,2	10 300	10 300	10 300	10 300	10 300	10 300	78,0
80,0	35,3	44,7	10 200	10 100	10 100	10 200	10 100	10 100	80,0
82,0	32,5	40,7	10 000	10 000	9 900	10 000	10 000	9 900	82,0
84,0	29,3	36,3	9 900	9 800	9 800	9 900	9 800	9 800	84,0
88,0									88,0

# MLC300 VPC-MAX S-2

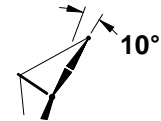
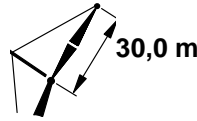
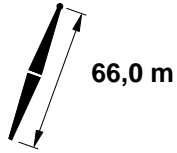
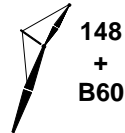

m	°	m	10,6 m			14,6 m			m			
			0°			1°				2°		
			kg	kg	kg	kg	kg	kg		kg	kg	
16,8	84,4	97,1	28 900			28 900			16,8			
18,0	83,6	96,8	28 500			28 500			18,0			
20,0	82,4	96,5	27 900	23 400	20 300 <sup>b</sup>	27 900	23 400	20 300 <sup>b</sup>	20,0			
22,0	81,2	96,1	27 400	23 000	20 000	27 400	23 000	20 000	22,0			
24,0	80,0	95,6	26 800	22 600	19 700	26 800	22 600	19 700	24,0			
26,0	78,7	95,1	26 200	22 300	19 400	26 200	22 300	19 400	26,0			
28,0	77,5	94,5	25 600	21 800	19 100	25 600	21 800	19 100	28,0			
30,0	76,3	94,0	25 000	21 500	18 800	25 000	21 500	18 800	30,0			
32,0	75,0	93,3	24 400	21 100	18 500	24 400	21 100	18 500	32,0			
34,0	73,7	92,6	23 800	20 700	18 200	23 800	20 700	18 200	34,0			
36,0	72,5	91,9	23 200	20 400	17 900	23 200	20 400	17 900	36,0			
38,0	71,2	91,1	22 600	20 000	17 700	22 600	20 000	17 700	38,0			
40,0	69,9	90,2	22 100	19 700	17 400	22 100	19 700	17 400	40,0			
42,0	68,6	89,3	21 500	19 300	17 200	21 500	19 300	17 200	42,0			
44,0	67,3	88,4	21 100	18 900	16 900	21 100	18 900	16 900	44,0			
46,0	65,9	87,4	20 600	18 500	16 700	20 600	18 500	16 700	46,0			
48,0	64,6	86,3	20 100	18 200	16 400	20 100	18 200	16 400	48,0			
50,0	63,2	85,1	19 600	17 800	16 200	19 600	17 800	16 200	50,0			
52,0	61,8	83,9	19 000	17 400	15 900	19 000	17 400	15 900	52,0			
54,0	60,4	82,7	18 300	17 100	15 700	18 300	17 100	15 700	54,0			
56,0	59,0	81,3	17 800	16 800	15 400	17 800	16 800	15 400	56,0			
58,0	57,5	79,9	17 200	16 500	15 200	17 200	16 500	15 200	58,0			
60,0	56,0	78,4	16 700	16 200	14 900	16 700	16 200	14 900	60,0			
62,0	54,5	76,8	16 200	15 900	14 600	16 200	15 900	14 600	62,0			
64,0	52,9	75,2	15 700	15 600	14 400	15 700	15 600	14 400	64,0			
66,0	51,4	73,4	15 300	15 200	14 200	15 300	15 200	14 200	66,0			
68,0	49,7	71,6	14 900	14 700	14 000	14 900	14 700	14 000	68,0			
70,0	48,0	69,6	14 500	14 400	13 700	14 500	14 400	13 700	70,0			
72,0	46,3	67,5	14 100	14 000	13 500	14 100	14 000	13 500	72,0			
74,0	44,5	65,3	13 800	13 600	13 300	13 800	13 600	13 300	74,0			
76,0	42,7	62,9	13 400	13 300	13 200	13 400	13 300	13 200	76,0			
78,0	40,8	60,4	13 100	13 000	12 900	13 100	13 000	12 900	78,0			
80,0	38,7	57,6	12 800	12 700	12 600	12 800	12 700	12 600	80,0			
82,0	36,6	54,7	12 500	12 400	12 300	12 500	12 400	12 300	82,0			
84,0	34,4	51,5	12 200	12 100	12 000	12 200	12 100	12 000	84,0			
88,0	29,3	44,1	11 700	11 600	11 500	11 700	11 600	11 500	88,0			
92,0	23,2	34,5	11 300	11 200	11 100	11 300	11 200	11 100	92,0			

# MLC300 VPC-MAX S-2



148  
+  
B60

175 100 kg

360°

66,0 m

30,0 m

20°

m	°	m	10,6 m			14,6 m			m
			0°	1°	2°	0°	1°	2°	
			kg	kg	kg	kg	kg	kg	
16,8									16,8
18,0									18,0
20,0									20,0
22,0	84,0	95,1	24 000			24 000			22,0
24,0	82,8	94,7	23 500	20 600		23 500	20 600		24,0
26,0	81,5	94,1	22 900	20 300	17 800	22 900	20 300	17 800	26,0
28,0	80,3	93,6	22 000	19 900	17 600	22 000	19 900	17 600	28,0
30,0	79,0	93,0	21 200	19 600	17 400	21 200	19 600	17 400	30,0
32,0	77,8	92,3	20 300	19 300	17 200	20 300	19 300	17 200	32,0
34,0	76,5	91,6	19 600	18 900	17 000	19 600	18 900	17 000	34,0
36,0	75,2	90,9	18 900	18 600	16 800	18 900	18 600	16 800	36,0
38,0	73,9	90,1	18 200	18 100	16 600	18 200	18 100	16 600	38,0
40,0	72,6	89,2	17 600	17 500	16 300	17 600	17 500	16 300	40,0
42,0	71,3	88,3	17 000	16 900	16 100	17 000	16 900	16 100	42,0
44,0	69,9	87,3	16 500	16 400	15 900	16 500	16 400	15 900	44,0
46,0	68,6	86,3	16 000	15 900	15 600	16 000	15 900	15 600	46,0
48,0	67,2	85,2	15 500	15 400	15 300	15 500	15 400	15 300	48,0
50,0	65,8	84,1	15 100	15 000	14 900	15 100	15 000	14 900	50,0
52,0	64,4	82,9	14 600	14 600	14 500	14 600	14 600	14 500	52,0
54,0	63,0	81,6	14 200	14 200	14 100	14 200	14 200	14 100	54,0
56,0	61,5	80,2	13 900	13 800	13 700	13 900	13 800	13 700	56,0
58,0	60,0	78,8	13 500	13 400	13 300	13 500	13 400	13 300	58,0
60,0	58,5	77,3	13 200	13 100	13 000	13 200	13 100	13 000	60,0
62,0	57,0	75,7	12 800	12 800	12 700	12 800	12 800	12 700	62,0
64,0	55,4	74,0	12 500	12 500	12 400	12 500	12 500	12 400	64,0
66,0	53,8	72,2	12 200	12 200	12 100	12 200	12 200	12 100	66,0
68,0	52,1	70,3	12 000	11 900	11 800	12 000	11 900	11 800	68,0
70,0	50,4	68,3	11 700	11 600	11 600	11 700	11 600	11 600	70,0
72,0	48,7	66,1	11 500	11 400	11 300	11 500	11 400	11 300	72,0
74,0	46,8	63,9	11 200	11 200	11 100	11 200	11 200	11 100	74,0
76,0	44,9	61,4	11 000	11 000	10 900	11 000	11 000	10 900	76,0
78,0	43,0	58,8	10 800	10 700	10 700	10 800	10 700	10 700	78,0
80,0	40,9	56,0	10 600	10 600	10 500	10 600	10 600	10 500	80,0
82,0	38,7	53,0	10 400	10 400	10 300	10 400	10 400	10 300	82,0
84,0	36,4	49,7	10 200	10 200	10 200	10 200	10 200	10 200	84,0
88,0	31,1	41,9	9 900	9 900	9 900	9 900	9 900	9 900	88,0
92,0									92,0

# MLC300 VPC-MAX S-2

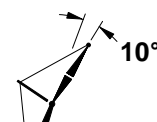
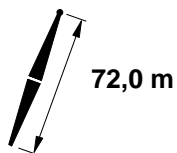
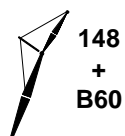

m	°	m	10,6 m			14,6 m			m			
			0°			1°				2°		
			kg	kg	kg	kg	kg	kg		kg	kg	
16,8	84,7	103,1	28 700			28 700			16,8			
18,0	84,0	102,9	28 400			28 400			18,0			
20,0	82,9	102,6	27 800	23 300	20 200	27 800	23 300	20 200	20,0			
22,0	81,7	102,2	27 300	22 900	19 900	27 300	22 900	19 900	22,0			
24,0	80,6	101,8	26 800	22 600	19 600	26 800	22 600	19 600	24,0			
26,0	79,4	101,3	26 300	22 200	19 300	26 300	22 200	19 300	26,0			
28,0	78,3	100,8	25 700	21 800	19 000	25 700	21 800	19 000	28,0			
30,0	77,1	100,2	25 200	21 500	18 800	25 200	21 500	18 800	30,0			
32,0	75,9	99,6	24 700	21 200	18 500	24 700	21 200	18 500	32,0			
34,0	74,7	99,0	24 100	20 800	18 200	24 100	20 800	18 200	34,0			
36,0	73,6	98,3	23 500	20 500	18 000	23 500	20 500	18 000	36,0			
38,0	72,4	97,5	23 000	20 200	17 800	23 000	20 200	17 800	38,0			
40,0	71,1	96,7	22 500	19 900	17 500	22 500	19 900	17 500	40,0			
42,0	69,9	95,9	22 000	19 500	17 300	22 000	19 500	17 300	42,0			
44,0	68,7	95,0	21 500	19 200	17 000	21 500	19 200	17 000	44,0			
46,0	67,5	94,1	21 000	18 900	16 800	21 000	18 900	16 800	46,0			
48,0	66,2	93,1	20 600	18 500	16 600	20 600	18 500	16 600	48,0			
50,0	64,9	92,0	20 200	18 200	16 400	20 200	18 200	16 400	50,0			
52,0	63,7	90,9	19 700	17 800	16 100	19 700	17 800	16 100	52,0			
54,0	62,4	89,7	19 200	17 500	15 900	19 200	17 500	15 900	54,0			
56,0	61,0	88,5	18 600	17 200	15 700	18 600	17 200	15 700	56,0			
58,0	59,7	87,2	18 000	16 900	15 500	18 000	16 900	15 500	58,0			
60,0	58,3	85,9	17 500	16 600	15 200	17 500	16 600	15 200	60,0			
62,0	57,0	84,4	17 000	16 300	15 000	17 000	16 300	15 000	62,0			
64,0	55,6	82,9	16 500	16 000	14 800	16 500	16 000	14 800	64,0			
66,0	54,1	81,3	16 100	15 800	14 500	16 100	15 800	14 500	66,0			
68,0	52,7	79,7	15 700	15 400	14 300	15 700	15 400	14 300	68,0			
70,0	51,2	77,9	15 200	15 100	14 100	15 200	15 100	14 100	70,0			
72,0	49,6	76,0	14 900	14 700	13 900	14 900	14 700	13 900	72,0			
74,0	48,1	74,1	14 500	14 400	13 700	14 500	14 400	13 700	74,0			
76,0	46,4	72,0	14 100	14 000	13 500	14 100	14 000	13 500	76,0			
78,0	44,8	69,8	13 800	13 700	13 300	13 800	13 700	13 300	78,0			
80,0	43,0	67,5	13 500	13 400	13 200	13 500	13 400	13 200	80,0			
82,0	41,3	65,0	13 200	13 100	12 900	13 200	13 100	12 900	82,0			
84,0	39,4	62,3	12 900	12 800	12 700	12 900	12 800	12 700	84,0			
88,0	35,4	56,4	12 300	12 300	12 100	12 300	12 300	12 100	88,0			
92,0	30,9	49,5	11 900	11 800	11 600	11 900	11 800	11 700	92,0			
96,0	25,5	40,8	11 200	10 900	10 700	11 400	11 400	11 300	96,0			
100,0	18,6	29,1	9 800	9 600	9 400	11 100	11 000	10 900	100,0			

# MLC300 VPC-MAX S-2

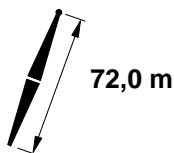

m	°	m	10,6 m			14,6 m			m
			0°	1°	2°	0°	1°	2°	
			kg	kg	kg	kg	kg	kg	
16,8									16,8
18,0									18,0
20,0									20,0
22,0	84,4	101,2	24 000			24 000			22,0
24,0	83,2	100,8	23 500	20 500		23 500	20 500		24,0
26,0	82,0	100,3	23 000	20 200	17 700	23 000	20 200	17 700	26,0
28,0	80,9	99,8	22 400	19 900	17 500	22 400	19 900	17 500	28,0
30,0	79,7	99,2	21 600	19 600	17 300	21 600	19 600	17 300	30,0
32,0	78,5	98,6	20 800	19 400	17 200	20 800	19 400	17 200	32,0
34,0	77,3	98,0	20 000	19 000	17 000	20 000	19 000	17 000	34,0
36,0	76,1	97,3	19 300	18 700	16 800	19 300	18 700	16 800	36,0
38,0	74,9	96,5	18 700	18 400	16 600	18 700	18 400	16 600	38,0
40,0	73,7	95,7	18 100	18 000	16 400	18 100	18 000	16 400	40,0
42,0	72,5	94,9	17 500	17 400	16 200	17 500	17 400	16 200	42,0
44,0	71,2	94,0	17 000	16 900	16 000	17 000	16 900	16 000	44,0
46,0	70,0	93,0	16 500	16 400	15 800	16 500	16 400	15 800	46,0
48,0	68,7	92,0	16 000	15 900	15 600	16 000	15 900	15 600	48,0
50,0	67,4	90,9	15 600	15 500	15 300	15 600	15 500	15 300	50,0
52,0	66,1	89,8	15 100	15 000	14 900	15 100	15 000	14 900	52,0
54,0	64,8	88,6	14 700	14 600	14 500	14 700	14 600	14 500	54,0
56,0	63,5	87,4	14 400	14 300	14 200	14 400	14 300	14 200	56,0
58,0	62,1	86,1	14 000	13 900	13 800	14 000	13 900	13 800	58,0
60,0	60,7	84,7	13 700	13 600	13 500	13 700	13 600	13 500	60,0
62,0	59,3	83,2	13 300	13 300	13 200	13 300	13 300	13 200	62,0
64,0	57,9	81,7	13 000	12 900	12 900	13 000	12 900	12 900	64,0
66,0	56,4	80,1	12 700	12 700	12 600	12 700	12 700	12 600	66,0
68,0	55,0	78,4	12 400	12 400	12 300	12 400	12 400	12 300	68,0
70,0	53,4	76,6	12 200	12 100	12 000	12 200	12 100	12 000	70,0
72,0	51,9	74,7	11 900	11 900	11 800	11 900	11 900	11 800	72,0
74,0	50,3	72,7	11 700	11 600	11 600	11 700	11 600	11 600	74,0
76,0	48,6	70,6	11 500	11 400	11 300	11 500	11 400	11 300	76,0
78,0	46,9	68,4	11 200	11 200	11 100	11 200	11 200	11 100	78,0
80,0	45,2	66,0	11 000	11 000	10 900	11 000	11 000	10 900	80,0
82,0	43,3	63,4	10 800	10 800	10 700	10 800	10 800	10 700	82,0
84,0	41,4	60,7	10 600	10 600	10 600	10 600	10 600	10 600	84,0
88,0	37,3	54,6	10 300	10 200	10 200	10 300	10 200	10 200	88,0
92,0	32,6	47,4	10 000	10 000	9 900	10 000	10 000	9 900	92,0
96,0	27,0	38,3	9 800			9 800			96,0
100,0									100,0



# MLC300 VPC-MAX S-2

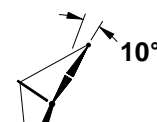
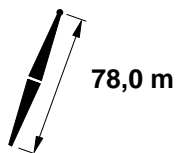

m	°	m	10,6 m			14,6 m			m
			0°			0°			
			kg	kg	kg	kg	kg	kg	
18,3	84,2	109,0	28 000			28 000			18,3
20,0	83,3	108,7	27 600	23 000		27 600	23 000		20,0
22,0	82,2	108,3	27 100	22 700	19 600	27 100	22 700	19 600	22,0
24,0	81,1	107,9	26 600	22 400	19 400	26 600	22 400	19 400	24,0
26,0	80,0	107,4	26 200	22 000	19 100	26 200	22 000	19 100	26,0
28,0	78,9	107,0	25 700	21 700	18 900	25 700	21 700	18 900	28,0
30,0	77,8	106,4	25 200	21 400	18 600	25 200	21 400	18 600	30,0
32,0	76,7	105,9	24 800	21 100	18 400	24 800	21 100	18 400	32,0
34,0	75,6	105,3	24 300	20 800	18 200	24 300	20 800	18 200	34,0
36,0	74,5	104,6	23 700	20 500	17 900	23 700	20 500	17 900	36,0
38,0	73,4	103,9	23 200	20 200	17 700	23 200	20 200	17 700	38,0
40,0	72,3	103,2	22 700	19 900	17 500	22 700	19 900	17 500	40,0
42,0	71,1	102,4	22 300	19 600	17 300	22 300	19 600	17 300	42,0
44,0	70,0	101,6	21 800	19 300	17 100	21 800	19 300	17 100	44,0
46,0	68,8	100,7	21 400	19 000	16 900	21 400	19 000	16 900	46,0
48,0	67,6	99,8	20 900	18 700	16 600	20 900	18 700	16 600	48,0
50,0	66,5	98,8	20 500	18 400	16 400	20 500	18 400	16 400	50,0
52,0	65,3	97,7	20 100	18 100	16 200	20 100	18 100	16 200	52,0
54,0	64,1	96,7	19 700	17 800	16 000	19 700	17 800	16 000	54,0
56,0	62,8	95,5	19 300	17 500	15 800	19 300	17 500	15 800	56,0
58,0	61,6	94,3	18 700	17 200	15 600	18 700	17 200	15 600	58,0
60,0	60,4	93,1	18 200	16 900	15 400	18 200	16 900	15 400	60,0
62,0	59,1	91,8	17 700	16 600	15 200	17 700	16 600	15 200	62,0
64,0	57,8	90,4	17 200	16 300	15 000	17 200	16 300	15 000	64,0
66,0	56,5	88,9	16 700	16 100	14 800	16 700	16 100	14 800	66,0
68,0	55,1	87,4	16 300	15 900	14 600	16 300	15 900	14 600	68,0
70,0	53,8	85,8	15 900	15 600	14 400	15 900	15 600	14 400	70,0
72,0	52,4	84,1	15 500	15 300	14 200	15 500	15 300	14 200	72,0
74,0	51,0	82,4	15 100	15 000	14 000	15 100	15 000	14 000	74,0
76,0	49,5	80,5	14 800	14 600	13 800	14 800	14 600	13 800	76,0
78,0	48,1	78,5	14 400	14 300	13 600	14 400	14 300	13 600	78,0
80,0	46,5	76,5	14 100	14 000	13 500	14 100	14 000	13 500	80,0
82,0	45,0	74,3	13 800	13 600	13 300	13 800	13 600	13 300	82,0
84,0	43,4	72,0	13 500	13 400	13 100	13 500	13 400	13 100	84,0
88,0	40,0	67,0	12 900	12 800	12 500	12 900	12 800	12 700	88,0
92,0	36,3	61,3	12 000	11 500	11 100	12 400	12 300	12 200	92,0
96,0	32,2	54,7	10 500	10 100	9 700	12 000	11 900	11 800	96,0
100,0	27,4	46,7	9 000	8 700	8 500	11 600	11 500	11 400	100,0
104,0	21,6	36,5	7 700	7 500	7 200	11 200	11 100	11 100	104,0

# MLC300 VPC-MAX S-2



148  
+  
B60

175 100 kg

360°

78,0 m

30,0 m

20°

m	°	m	10,6 m			14,6 m			m			
			0°			1°				2°		
			kg	kg	kg	kg	kg	kg		kg	kg	kg
18,3										18,3		
20,0										20,0		
22,0										22,0		
24,0	83,6	106,9	23 400			23 400				24,0		
26,0	82,5	106,5	23 000	20 100	17 600	23 000	20 100	17 600		26,0		
28,0	81,4	106,0	22 500	19 800	17 400	22 500	19 800	17 400		28,0		
30,0	80,3	105,4	21 900	19 600	17 200	21 900	19 600	17 200		30,0		
32,0	79,2	104,9	21 100	19 300	17 000	21 100	19 300	17 000		32,0		
34,0	78,1	104,2	20 400	19 100	16 900	20 400	19 100	16 900		34,0		
36,0	76,9	103,6	19 700	18 800	16 700	19 700	18 800	16 700		36,0		
38,0	75,8	102,9	19 100	18 500	16 600	19 100	18 500	16 600		38,0		
40,0	74,7	102,1	18 500	18 200	16 400	18 500	18 200	16 400		40,0		
42,0	73,5	101,3	18 000	17 700	16 200	18 000	17 700	16 200		42,0		
44,0	72,4	100,5	17 400	17 300	16 000	17 400	17 300	16 000		44,0		
46,0	71,2	99,6	16 900	16 800	15 900	16 900	16 800	15 900		46,0		
48,0	70,0	98,7	16 400	16 300	15 700	16 400	16 300	15 700		48,0		
50,0	68,8	97,7	16 000	15 900	15 500	16 000	15 900	15 500		50,0		
52,0	67,6	96,7	15 600	15 500	15 300	15 600	15 500	15 300		52,0		
54,0	66,4	95,6	15 200	15 100	14 900	15 200	15 100	14 900		54,0		
56,0	65,1	94,4	14 800	14 700	14 600	14 800	14 700	14 600		56,0		
58,0	63,9	93,2	14 400	14 300	14 200	14 400	14 300	14 200		58,0		
60,0	62,6	91,9	14 100	14 000	13 900	14 100	14 000	13 900		60,0		
62,0	61,3	90,6	13 800	13 700	13 600	13 800	13 700	13 600		62,0		
64,0	60,0	89,2	13 400	13 400	13 300	13 400	13 400	13 300		64,0		
66,0	58,7	87,7	13 200	13 100	13 000	13 200	13 100	13 000		66,0		
68,0	57,4	86,2	12 900	12 800	12 700	12 900	12 800	12 700		68,0		
70,0	56,0	84,5	12 600	12 500	12 400	12 600	12 500	12 400		70,0		
72,0	54,6	82,8	12 300	12 300	12 200	12 300	12 300	12 200		72,0		
74,0	53,1	81,0	12 100	12 000	12 000	12 100	12 000	12 000		74,0		
76,0	51,7	79,2	11 900	11 800	11 700	11 900	11 800	11 700		76,0		
78,0	50,2	77,2	11 600	11 600	11 500	11 600	11 600	11 500		78,0		
80,0	48,6	75,1	11 400	11 400	11 300	11 400	11 400	11 300		80,0		
82,0	47,0	72,9	11 200	11 200	11 100	11 200	11 200	11 100		82,0		
84,0	45,4	70,5	11 000	11 000	10 900	11 000	11 000	10 900		84,0		
88,0	41,9	65,4	10 700	10 600	10 600	10 700	10 600	10 600		88,0		
92,0	38,1	59,5	10 400	10 300	10 300	10 400	10 300	10 300		92,0		
96,0	33,8	52,6	10 100	10 000	9 800	10 100	10 000	10 000		96,0		
100,0	28,9	44,3	9 300	9 000	8 700	9 800	9 800	9 800		100,0		
104,0										104,0		

# MLC300 VPC-MAX S-2

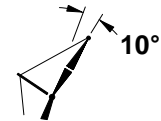
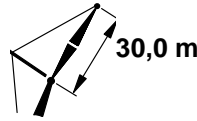
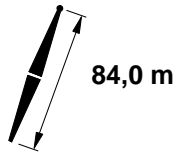

m	°	m	10,6 m			14,6 m			m			
			0°			1°				2°		
			kg	kg	kg	kg	kg	kg		kg	kg	kg
18,3	84,5	115,0	27 700	22 700		27 700	22 700		18,3			
20,0	83,6	114,7	27 400	22 400	19 400	27 400	22 400	19 400	20,0			
22,0	82,6	114,4	26 900	22 100	19 100	26 900	22 100	19 100	22,0			
24,0	81,6	114,0	26 500	21 900	18 900	26 500	21 900	18 900	24,0			
26,0	80,6	113,6	26 100	21 600	18 700	26 100	21 600	18 700	26,0			
28,0	79,5	113,1	25 600	21 300	18 500	25 600	21 300	18 500	28,0			
30,0	78,5	112,6	25 200	21 000	18 300	25 200	21 000	18 300	30,0			
32,0	77,4	112,1	24 800	20 700	18 100	24 800	20 700	18 100	32,0			
34,0	76,4	111,5	24 400	20 400	17 900	24 400	20 400	17 900	34,0			
36,0	75,4	110,9	23 900	20 100	17 700	23 900	20 100	17 900	36,0			
38,0	74,3	110,3	23 500	19 900	17 600	23 500	20 200	17 600	38,0			
40,0	73,2	109,6	23 000	19 700	17 400	23 000	19 900	17 400	40,0			
42,0	72,2	108,8	22 500	19 500	17 300	22 500	19 700	17 300	42,0			
44,0	71,1	108,0	22 100	19 400	17 100	22 100	19 400	17 100	44,0			
46,0	70,0	107,2	21 700	19 100	16 900	21 700	19 100	16 900	46,0			
48,0	68,9	106,4	21 300	18 900	16 700	21 300	18 900	16 700	48,0			
50,0	67,8	105,4	20 900	18 600	16 500	20 900	18 600	16 500	50,0			
52,0	66,7	104,5	20 500	18 300	16 300	20 500	18 300	16 300	52,0			
54,0	65,6	103,5	20 100	18 000	16 100	20 100	18 000	16 100	54,0			
56,0	64,4	102,4	19 700	17 700	15 900	19 700	17 700	15 900	56,0			
58,0	63,3	101,3	19 400	17 400	15 700	19 400	17 400	15 700	58,0			
60,0	62,1	100,1	18 900	17 200	15 600	18 900	17 200	15 600	60,0			
62,0	60,9	98,9	18 400	16 900	15 400	18 400	16 900	15 400	62,0			
64,0	59,7	97,6	17 900	16 700	15 200	17 900	16 700	15 200	64,0			
66,0	58,5	96,3	17 400	16 400	15 000	17 400	16 400	15 000	66,0			
68,0	57,3	94,9	17 000	16 200	14 800	17 000	16 200	14 800	68,0			
70,0	56,1	93,4	16 600	15 900	14 600	16 600	15 900	14 600	70,0			
72,0	54,8	91,9	16 200	15 700	14 400	16 200	15 700	14 400	72,0			
74,0	53,5	90,3	15 800	15 500	14 300	15 800	15 500	14 300	74,0			
76,0	52,2	88,6	15 400	15 200	14 100	15 400	15 200	14 100	76,0			
78,0	50,8	86,8	15 100	14 900	13 900	15 100	14 900	13 900	78,0			
80,0	49,5	85,0	14 700	14 600	13 700	14 700	14 600	13 700	80,0			
82,0	48,1	83,0	14 400	14 300	13 600	14 400	14 300	13 600	82,0			
84,0	46,6	81,0	14 100	13 600	13 000	14 100	14 000	13 400	84,0			
88,0	43,6	76,6	12 600	12 000	11 400	13 500	13 400	13 100	88,0			
92,0	40,5	71,7	11 000	10 400	10 000	13 000	12 900	12 800	92,0			
96,0	37,0	66,1	9 400	9 000	8 600	12 500	12 400	12 300	96,0			
100,0	33,3	59,8	8 000	7 700	7 300	12 100	12 000	11 900	100,0			
104,0	29,0	52,3	6 700	6 400	6 100	11 700	11 600	11 500	104,0			
108,0	24,0	43,1	5 500	5 300	5 000	11 300	11 200	11 200	108,0			

# MLC300 VPC-MAX S-2



148  
+  
B60

175 100 kg

360°

84,0 m

30,0 m

20°

m	°	m	10,6 m			14,6 m			m			
			0°			1°				2°		
			kg	kg	kg	kg	kg	kg		kg	kg	
18,3									18,3			
20,0									20,0			
22,0									22,0			
24,0	83,9	113,0	23 400			23 400			24,0			
26,0	82,9	112,6	23 000	19 900	17 400	23 000	19 900	17 400	26,0			
28,0	81,9	112,1	22 600	19 700	17 200	22 600	19 700	17 200	28,0			
30,0	80,8	111,6	22 100	19 500	17 100	22 100	19 500	17 100	30,0			
32,0	79,8	111,1	21 500	19 200	16 900	21 500	19 200	16 900	32,0			
34,0	78,7	110,5	20 800	19 000	16 800	20 800	19 000	16 800	34,0			
36,0	77,7	109,9	20 100	18 800	16 700	20 100	18 800	16 700	36,0			
38,0	76,6	109,2	19 500	18 500	16 500	19 500	18 500	16 500	38,0			
40,0	75,5	108,5	18 900	18 300	16 300	18 900	18 300	16 300	40,0			
42,0	74,4	107,8	18 300	18 000	16 200	18 300	18 000	16 200	42,0			
44,0	73,3	107,0	17 800	17 600	16 000	17 800	17 600	16 000	44,0			
46,0	72,3	106,2	17 300	17 200	15 900	17 300	17 200	15 900	46,0			
48,0	71,1	105,3	16 900	16 700	15 700	16 900	16 700	15 700	48,0			
50,0	70,0	104,4	16 400	16 300	15 600	16 400	16 300	15 600	50,0			
52,0	68,9	103,4	16 000	15 900	15 400	16 000	15 900	15 400	52,0			
54,0	67,8	102,4	15 600	15 500	15 200	15 600	15 500	15 200	54,0			
56,0	66,6	101,3	15 200	15 100	14 900	15 200	15 100	14 900	56,0			
58,0	65,5	100,2	14 900	14 700	14 600	14 900	14 700	14 600	58,0			
60,0	64,3	99,0	14 500	14 400	14 300	14 500	14 400	14 300	60,0			
62,0	63,1	97,7	14 200	14 100	14 000	14 200	14 100	14 000	62,0			
64,0	61,9	96,4	13 900	13 800	13 700	13 900	13 800	13 700	64,0			
66,0	60,7	95,1	13 600	13 500	13 400	13 600	13 500	13 400	66,0			
68,0	59,4	93,7	13 300	13 200	13 100	13 300	13 200	13 100	68,0			
70,0	58,1	92,2	13 000	12 900	12 800	13 000	12 900	12 800	70,0			
72,0	56,9	90,6	12 800	12 700	12 600	12 800	12 700	12 600	72,0			
74,0	55,6	89,0	12 500	12 400	12 400	12 500	12 400	12 400	74,0			
76,0	54,2	87,3	12 300	12 200	12 100	12 300	12 200	12 100	76,0			
78,0	52,9	85,5	12 000	12 000	11 900	12 000	12 000	11 900	78,0			
80,0	51,5	83,6	11 800	11 700	11 700	11 800	11 700	11 700	80,0			
82,0	50,0	81,6	11 600	11 500	11 500	11 600	11 500	11 500	82,0			
84,0	48,6	79,6	11 400	11 300	11 300	11 400	11 300	11 300	84,0			
88,0	45,5	75,1	11 000	11 000	10 900	11 000	11 000	10 900	88,0			
92,0	42,3	70,0	10 700	10 600	10 400	10 700	10 600	10 600	92,0			
96,0	38,8	64,3	9 900	9 400	9 000	10 400	10 300	10 300	96,0			
100,0	34,9	57,8	8 400	8 000	7 700	10 100	10 100	10 000	100,0			
104,0	30,4	50,0	7 000	6 700	6 400	9 900	9 900	9 800	104,0			
108,0									108,0			

# MLC300 VPC-MAX S-2

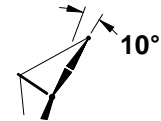
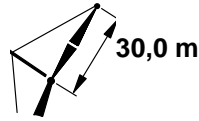
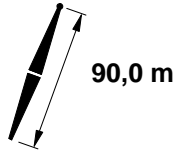
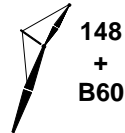

m	°	m	10,6 m			14,6 m			m			
			0°			1°				2°		
			kg	kg	kg	kg	kg	kg		kg	kg	kg
18,3	84,8	121,1	27 200			27 200			18,3			
20,0	83,9	120,8	26 900			26 900			20,0			
22,0	83,0	120,5	26 500	22 000		26 500	22 000		22,0			
24,0	82,0	120,1	26 100	21 800	18 500	26 100	21 800	18 500	24,0			
26,0	81,0	119,7	25 700	21 500	18 500	25 700	21 500	18 500	26,0			
28,0	80,1	119,3	25 300	21 300	18 400	25 300	21 300	18 400	28,0			
30,0	79,1	118,8	25 000	21 000	18 200	25 000	21 000	18 200	30,0			
32,0	78,1	118,3	24 600	20 700	18 000	24 600	20 700	18 000	32,0			
34,0	77,1	117,8	24 300	20 500	17 800	24 300	20 500	17 800	34,0			
36,0	76,1	117,2	23 900	20 300	17 600	23 900	20 300	17 600	36,0			
38,0	75,1	116,6	23 500	20 000	17 500	23 500	20 000	17 500	38,0			
40,0	74,1	115,9	23 100	19 800	17 300	23 100	19 800	17 300	40,0			
42,0	73,1	115,2	22 600	19 500	17 100	22 600	19 500	17 100	42,0			
44,0	72,1	114,5	22 200	19 300	16 900	22 200	19 300	16 900	44,0			
46,0	71,1	113,7	21 800	19 100	16 700	21 800	19 100	16 700	46,0			
48,0	70,0	112,9	21 400	18 800	16 600	21 400	18 800	16 600	48,0			
50,0	69,0	112,0	21 000	18 600	16 400	21 000	18 600	16 400	50,0			
52,0	67,9	111,1	20 700	18 400	16 200	20 700	18 400	16 200	52,0			
54,0	66,9	110,2	20 300	18 100	16 100	20 300	18 100	16 100	54,0			
56,0	65,8	109,2	20 000	17 900	15 900	20 000	17 900	15 900	56,0			
58,0	64,7	108,1	19 600	17 600	15 800	19 600	17 600	15 800	58,0			
60,0	63,7	107,0	19 300	17 400	15 600	19 300	17 400	15 600	60,0			
62,0	62,6	105,9	19 000	17 100	15 400	19 000	17 100	15 400	62,0			
64,0	61,4	104,7	18 500	16 900	15 300	18 500	16 900	15 300	64,0			
66,0	60,3	103,5	18 000	16 600	15 100	18 000	16 600	15 100	66,0			
68,0	59,2	102,2	17 600	16 400	14 900	17 600	16 400	14 900	68,0			
70,0	58,0	100,8	17 200	16 100	14 800	17 200	16 100	14 800	70,0			
72,0	56,9	99,4	16 800	15 700	14 600	16 800	15 700	14 600	72,0			
74,0	55,7	97,9	16 400	15 400	14 400	16 400	15 400	14 400	74,0			
76,0	54,5	96,4	16 000	15 100	14 300	16 000	15 100	14 300	76,0			
78,0	53,2	94,7	15 600	14 800	14 100	15 600	14 800	14 100	78,0			
80,0	52,0	93,1	15 300	14 400	13 800	15 300	14 500	13 900	80,0			
82,0	50,7	91,3	14 800	14 000	13 300	15 000	14 200	13 600	82,0			
84,0	49,4	89,4	13 900	13 200	12 500	14 600	14 000	13 400	84,0			
88,0	46,7	85,5	12 200	11 500	10 900	14 100	13 500	13 000	88,0			
92,0	43,9	81,1	10 500	10 000	9 400	13 500	13 100	12 600	92,0			
96,0	40,9	76,3	9 000	8 600	8 100	13 000	12 800	12 300	96,0			
100,0	37,7	70,9	7 700	7 200	6 800	12 600	12 400	12 000	100,0			
104,0	34,2	64,8	6 400	6 000	5 600	12 200	12 100	11 900	104,0			
108,0	30,3	57,7	5 200	4 800	4 500	11 800	11 700	11 600	108,0			
112,0	25,9	49,2	4 000	3 800	3 500	11 500	11 300	11 000	112,0			
116,0	20,4	38,4				10 700			116,0			

# MLC300 VPC-MAX S-2

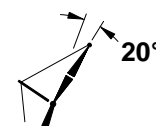
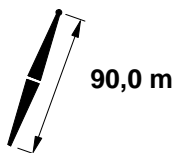

m	°	m	10,6 m			14,6 m			m
			0°	1°	2°	0°	1°	2°	
			kg	kg	kg	kg	kg	kg	
18,3									18,3
20,0									20,0
22,0									22,0
24,0	84,3	119,1	23 200			23 200			24,0
26,0	83,3	118,7	22 800	19 600		22 800	19 600		26,0
28,0	82,3	118,3	22 500	19 400	16 100	22 500	19 400	16 100	28,0
30,0	81,3	117,8	22 100	19 300	16 100	22 100	19 300	16 100	30,0
32,0	80,3	117,3	21 700	19 100	16 000	21 700	19 100	16 000	32,0
34,0	79,3	116,7	21 000	18 900	15 800	21 000	18 900	15 800	34,0
36,0	78,3	116,1	20 300	18 700	15 700	20 300	18 700	15 700	36,0
38,0	77,3	115,5	19 800	18 500	15 500	19 800	18 500	15 500	38,0
40,0	76,3	114,9	19 200	18 300	15 400	19 200	18 300	15 400	40,0
42,0	75,3	114,2	18 700	18 000	15 200	18 700	18 000	15 200	42,0
44,0	74,2	113,4	18 100	17 800	15 100	18 100	17 800	15 100	44,0
46,0	73,2	112,6	17 700	17 500	14 900	17 700	17 500	14 900	46,0
48,0	72,2	111,8	17 200	17 000	14 700	17 200	17 000	14 700	48,0
50,0	71,1	110,9	16 800	16 600	14 500	16 800	16 600	14 500	50,0
52,0	70,1	110,0	16 300	16 200	14 400	16 300	16 200	14 400	52,0
54,0	69,0	109,1	15 900	15 800	14 200	15 900	15 800	14 200	54,0
56,0	67,9	108,1	15 600	15 500	14 100	15 600	15 500	14 100	56,0
58,0	66,8	107,0	15 200	15 100	13 900	15 200	15 100	13 900	58,0
60,0	65,7	105,9	14 900	14 800	13 800	14 900	14 800	13 800	60,0
62,0	64,6	104,7	14 600	14 400	13 600	14 600	14 400	13 600	62,0
64,0	63,5	103,5	14 200	14 100	13 500	14 200	14 100	13 500	64,0
66,0	62,4	102,3	13 900	13 800	13 300	13 900	13 800	13 300	66,0
68,0	61,2	101,0	13 700	13 600	13 200	13 700	13 600	13 200	68,0
70,0	60,0	99,6	13 400	13 300	13 100	13 400	13 300	13 100	70,0
72,0	58,8	98,1	13 100	13 000	12 900	13 100	13 000	12 900	72,0
74,0	57,6	96,6	12 900	12 800	12 700	12 900	12 800	12 700	74,0
76,0	56,4	95,1	12 600	12 500	12 500	12 600	12 500	12 500	76,0
78,0	55,2	93,4	12 400	12 300	12 200	12 400	12 300	12 200	78,0
80,0	53,9	91,7	12 200	12 100	12 000	12 200	12 100	12 000	80,0
82,0	52,6	89,9	12 000	11 900	11 800	12 000	11 900	11 800	82,0
84,0	51,3	88,1	11 800	11 700	11 600	11 800	11 700	11 600	84,0
88,0	48,6	84,0	11 400	11 300	11 300	11 400	11 300	11 300	88,0
92,0	45,7	79,6	11 000	10 600	10 000	11 000	11 000	10 900	92,0
96,0	42,6	74,6	9 600	9 100	8 600	10 700	10 700	10 600	96,0
100,0	39,3	69,1	8 100	7 700	7 200	10 400	10 400	10 300	100,0
104,0	35,7	62,8	6 700	6 400	6 000	10 200	10 100	10 100	104,0
108,0	31,7	55,5	5 500	5 100	4 800	10 000	9 900	9 900	108,0
112,0	27,0	46,6	4 200	4 000	3 700	9 800	9 800	9 700	112,0
116,0									116,0

# MLC300 VPC-MAX S-2

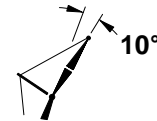
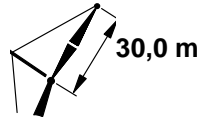
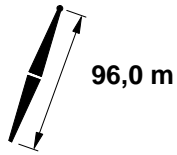
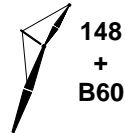

m	°	m	10,6 m			14,6 m			m			
			0°			1°				2°		
			kg	kg	kg	kg	kg	kg		kg	kg	
19,8	84,3	126,9	26 500			26 500			19,8			
20,0	84,2	126,9	26 500			26 500			20,0			
22,0	83,3	126,6	26 100	21 600		26 100	21 600		22,0			
24,0	82,4	126,2	25 800	21 500	15 600	25 800	21 500	15 600	24,0			
26,0	81,5	125,8	25 500	21 200	15 600	25 500	21 200	15 600	26,0			
28,0	80,5	125,4	25 200	21 000	15 600	25 200	21 000	15 600	28,0			
30,0	79,6	125,0	24 800	20 800	15 600	24 800	20 800	15 600	30,0			
32,0	78,7	124,5	24 500	20 500	15 600	24 500	20 500	15 600	32,0			
34,0	77,7	124,0	24 200	20 300	15 600	24 200	20 300	15 600	34,0			
36,0	76,8	123,4	23 800	20 100	15 600	23 800	20 100	15 600	36,0			
38,0	75,8	122,9	23 500	19 900	15 600	23 500	19 900	15 600	38,0			
40,0	74,9	122,2	23 100	19 700	15 600	23 100	19 700	15 600	40,0			
42,0	73,9	121,6	22 800	19 400	15 600	22 800	19 400	15 600	42,0			
44,0	73,0	120,9	22 400	19 200	15 600	22 400	19 200	15 600	44,0			
46,0	72,0	120,1	22 000	19 000	15 600	22 000	19 000	15 600	46,0			
48,0	71,0	119,4	21 600	18 800	15 600	21 600	18 800	15 600	48,0			
50,0	70,0	118,6	21 300	18 600	15 600	21 300	18 600	15 600	50,0			
52,0	69,1	117,7	20 900	18 400	15 600	20 900	18 400	15 600	52,0			
54,0	68,1	116,8	20 600	18 200	15 600	20 600	18 200	15 600	54,0			
56,0	67,1	115,9	20 300	18 000	15 600	20 300	18 000	15 600	56,0			
58,0	66,0	114,9	19 900	17 800	15 600	19 900	17 800	15 600	58,0			
60,0	65,0	113,9	19 600	17 500	15 500	19 600	17 500	15 500	60,0			
62,0	64,0	112,8	19 300	17 300	15 500	19 300	17 300	15 500	62,0			
64,0	63,0	111,7	19 000	17 100	15 300	19 000	17 100	15 300	64,0			
66,0	61,9	110,5	18 700	16 800	15 200	18 700	16 800	15 200	66,0			
68,0	60,8	109,3	18 300	16 600	15 000	18 300	16 600	15 000	68,0			
70,0	59,8	108,0	17 800	16 400	14 900	17 800	16 400	14 900	70,0			
72,0	58,7	106,7	17 400	16 200	14 700	17 400	16 200	14 700	72,0			
74,0	57,6	105,3	17 000	16 000	14 600	17 000	16 000	14 600	74,0			
76,0	56,5	103,9	16 700	15 800	14 400	16 700	15 800	14 400	76,0			
78,0	55,3	102,4	15 900	14 900	13 800	16 300	15 600	14 300	78,0			
80,0	54,2	100,8	14 900	14 000	13 100	15 900	15 400	14 100	80,0			
82,0	53,0	99,2	13 900	13 000	12 200	15 600	15 200	14 000	82,0			
84,0	51,8	97,5	12 900	12 100	11 400	15 300	15 000	13 800	84,0			
88,0	49,4	93,9	11 100	10 400	9 800	14 700	14 500	13 500	88,0			
92,0	46,8	90,0	9 500	8 900	8 300	14 100	13 900	13 300	92,0			
96,0	44,1	85,7	8 000	7 500	6 900	13 600	13 400	13 000	96,0			
100,0	41,3	80,9	6 600	6 200	5 700	13 100	13 000	12 800	100,0			
104,0	38,3	75,6	5 400	4 900	4 500	12 700	12 500	12 400	104,0			
108,0	35,0	69,7	4 200	3 800	3 400	12 300	11 800	11 300	108,0			
112,0	31,5	62,9				11 100	10 700	10 200	112,0			
116,0	27,4	55,0				10 000	9 600	9 200	116,0			
120,0	22,7	45,3				8 900	8 600	8 300	120,0			

# MLC300 VPC-MAX S-2



148  
+  
B60

175 100 kg

360°

96,0 m

30,0 m

20°

m	°	m	10,6 m			14,6 m			m
			0°	1°	2°	0°	1°	2°	
			kg	kg	kg	kg	kg	kg	
19,8									19,8
20,0									20,0
22,0									22,0
24,0									24,0
26,0	83,6	124,8	22 700	19 300		22 700	19 300		26,0
28,0	82,7	124,4	22 400	19 200	13 500	22 400	19 200	13 500	28,0
30,0	81,7	123,9	22 100	19 000	13 500	22 100	19 000	13 500	30,0
32,0	80,8	123,5	21 700	18 900	13 500	21 700	18 900	13 500	32,0
34,0	79,8	122,9	21 300	18 700	13 500	21 300	18 700	13 500	34,0
36,0	78,9	122,4	20 700	18 600	13 500	20 700	18 600	13 500	36,0
38,0	77,9	121,8	20 100	18 400	13 500	20 100	18 400	13 500	38,0
40,0	77,0	121,2	19 600	18 200	13 500	19 600	18 200	13 500	40,0
42,0	76,0	120,5	19 000	18 000	13 500	19 000	18 000	13 500	42,0
44,0	75,0	119,8	18 500	17 800	13 500	18 500	17 800	13 500	44,0
46,0	74,1	119,1	18 100	17 600	13 500	18 100	17 600	13 500	46,0
48,0	73,1	118,3	17 600	17 400	13 500	17 600	17 400	13 500	48,0
50,0	72,1	117,4	17 200	17 000	13 500	17 200	17 000	13 500	50,0
52,0	71,1	116,6	16 800	16 600	13 500	16 800	16 600	13 500	52,0
54,0	70,1	115,7	16 400	16 200	13 500	16 400	16 200	13 500	54,0
56,0	69,1	114,7	16 000	15 900	13 500	16 000	15 900	13 500	56,0
58,0	68,0	113,7	15 600	15 500	13 500	15 600	15 500	13 500	58,0
60,0	67,0	112,7	15 300	15 200	13 500	15 300	15 200	13 500	60,0
62,0	66,0	111,6	15 000	14 800	13 500	15 000	14 800	13 500	62,0
64,0	64,9	110,5	14 700	14 500	13 500	14 700	14 500	13 500	64,0
66,0	63,9	109,3	14 400	14 200	13 400	14 400	14 200	13 400	66,0
68,0	62,8	108,1	14 100	14 000	13 300	14 100	14 000	13 300	68,0
70,0	61,7	106,8	13 800	13 700	13 200	13 800	13 700	13 200	70,0
72,0	60,6	105,5	13 500	13 400	13 000	13 500	13 400	13 000	72,0
74,0	59,5	104,1	13 300	13 200	12 900	13 300	13 200	12 900	74,0
76,0	58,3	102,6	13 000	12 900	12 800	13 000	12 900	12 800	76,0
78,0	57,2	101,1	12 800	12 700	12 600	12 800	12 700	12 600	78,0
80,0	56,0	99,5	12 600	12 500	12 400	12 600	12 500	12 400	80,0
82,0	54,8	97,9	12 400	12 300	12 200	12 400	12 300	12 200	82,0
84,0	53,6	96,2	12 100	12 100	11 800	12 100	12 100	12 000	84,0
88,0	51,1	92,5	11 700	11 100	10 500	11 700	11 700	11 600	88,0
92,0	48,5	88,5	10 200	9 600	8 900	11 400	11 300	11 300	92,0
96,0	45,8	84,1	8 600	8 100	7 500	11 100	11 000	10 900	96,0
100,0	42,9	79,2	7 200	6 700	6 200	10 800	10 700	10 600	100,0
104,0	39,9	73,8	5 800	5 400	5 000	10 500	10 400	10 400	104,0
108,0	36,5	67,8	4 500	4 200	3 800	10 200	10 200	10 100	108,0
112,0	32,8	60,8	3 300			10 000	10 000	9 900	112,0
116,0	28,6	52,5				9 800			116,0
120,0									120,0



# MLC300 VPC-MAX S-2

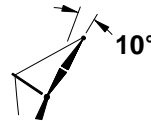
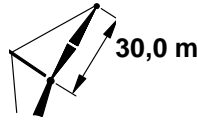
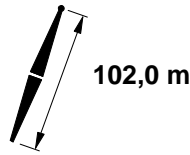

m	°	m	10,6 m		14,6 m		m
			0°		1°		
			kg	kg	kg	kg	
19,8	84,6	133,0	25 800		25 800		19,8
20,0	84,5	132,9	25 800		25 800		20,0
22,0	83,6	132,6	25 500	18 200	25 500	18 200	22,0
24,0	82,7	132,3	25 200	18 200	25 200	18 200	24,0
26,0	81,9	131,9	24 900	18 200	24 900	18 200	26,0
28,0	81,0	131,5	24 600	18 200	24 600	18 200	28,0
30,0	80,1	131,1	24 300	18 200	24 300	18 200	30,0
32,0	79,2	130,7	24 000	18 200	24 000	18 200	32,0
34,0	78,3	130,2	23 700	18 200	23 700	18 200	34,0
36,0	77,4	129,6	23 500	18 200	23 500	18 200	36,0
38,0	76,5	129,1	23 200	18 200	23 200	18 200	38,0
40,0	75,6	128,5	22 900	18 200	22 900	18 200	40,0
42,0	74,7	127,9	22 600	18 200	22 600	18 200	42,0
44,0	73,8	127,2	22 300	18 200	22 300	18 200	44,0
46,0	72,9	126,5	21 900	18 200	21 900	18 200	46,0
48,0	71,9	125,8	21 600	18 200	21 600	18 200	48,0
50,0	71,0	125,0	21 300	18 200	21 300	18 200	50,0
52,0	70,1	124,2	20 900	18 100	20 900	18 100	52,0
54,0	69,1	123,3	20 300	17 600	20 300	17 600	54,0
56,0	68,2	122,5	19 700	17 100	19 700	17 100	56,0
58,0	67,2	121,5	19 200	16 700	19 200	16 700	58,0
60,0	66,3	120,6	18 600	16 200	18 600	16 200	60,0
62,0	65,3	119,6	18 200	15 800	18 200	15 800	62,0
64,0	64,3	118,5	17 600	15 400	17 600	15 400	64,0
66,0	63,3	117,4	17 200	14 900	17 200	14 900	66,0
68,0	62,3	116,3	16 700	14 600	16 700	14 600	68,0
70,0	61,3	115,1	16 300	14 200	16 300	14 200	70,0
72,0	60,3	113,8	15 900	13 800	15 900	13 800	72,0
74,0	59,3	112,5	15 500	13 500	15 500	13 500	74,0
76,0	58,2	111,2	15 200	13 200	15 200	13 200	76,0
78,0	57,1	109,8	14 800	12 900	14 800	12 900	78,0
80,0	56,1	108,4	14 300	12 600	14 500	12 600	80,0
82,0	55,0	106,9	13 400	12 300	14 100	12 300	82,0
84,0	53,9	105,3	12 400	11 500	13 800	12 000	84,0
88,0	51,6	102,0	10 600	9 900	13 300	11 500	88,0
92,0	49,3	98,3	9 000	8 300	12 700	11 100	92,0
96,0	46,9	94,4	7 500	6 900	12 300	10 700	96,0
100,0	44,3	90,1	6 200	5 600	11 800	10 300	100,0
104,0	41,6	85,4	4 900	4 400	11 400	9 900	104,0
108,0	38,8	80,3	3 700		11 100	9 700	108,0
112,0	35,7	74,5			10 700	9 400	112,0
116,0	32,4	68,0			9 700	9 200	116,0
120,0	28,7	60,5			8 600	8 200	120,0
124,0	24,5	51,5			7 600	7 300	124,0
128,0	19,2	40,1			6 700	6 400	128,0

# MLC300 VPC-MAX S-2

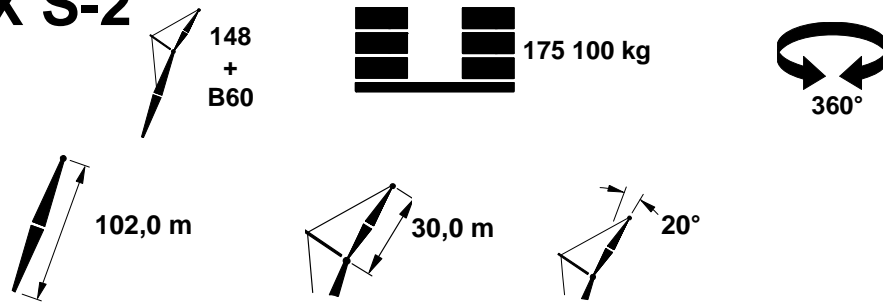

m	°	m	10,6 m		14,6 m		m
			0°		1°		
			kg	kg	kg	kg	
19,8							19,8
20,0							20,0
22,0							22,0
24,0							24,0
26,0	83,9	130,9	22 400	16 100	22 400	16 100	26,0
28,0	83,0	130,5	22 100	16 100	22 100	16 100	28,0
30,0	82,1	130,0	21 800	16 100	21 800	16 100	30,0
32,0	81,2	129,6	21 500	16 100	21 500	16 100	32,0
34,0	80,3	129,1	21 200	16 100	21 200	16 100	34,0
36,0	79,4	128,6	20 800	16 100	20 800	16 100	36,0
38,0	78,5	128,0	20 200	16 100	20 200	16 100	38,0
40,0	77,6	127,4	19 700	16 100	19 700	16 100	40,0
42,0	76,7	126,8	19 200	16 100	19 200	16 100	42,0
44,0	75,7	126,1	18 700	16 100	18 700	16 100	44,0
46,0	74,8	125,4	18 200	16 100	18 200	16 100	46,0
48,0	73,9	124,7	17 800	16 000	17 800	16 000	48,0
50,0	73,0	123,9	17 400	15 900	17 400	15 900	50,0
52,0	72,0	123,1	17 000	15 700	17 000	15 700	52,0
54,0	71,1	122,2	16 600	15 500	16 600	15 500	54,0
56,0	70,1	121,3	16 200	15 300	16 200	15 300	56,0
58,0	69,1	120,4	15 900	15 000	15 900	15 000	58,0
60,0	68,2	119,4	15 500	14 600	15 500	14 600	60,0
62,0	67,2	118,4	15 200	14 300	15 200	14 300	62,0
64,0	66,2	117,3	14 900	13 900	14 900	13 900	64,0
66,0	65,2	116,2	14 600	13 600	14 600	13 600	66,0
68,0	64,2	115,1	14 300	13 300	14 300	13 300	68,0
70,0	63,2	113,9	14 000	13 000	14 000	13 000	70,0
72,0	62,1	112,6	13 800	12 700	13 800	12 700	72,0
74,0	61,1	111,3	13 500	12 400	13 500	12 400	74,0
76,0	60,0	110,0	13 300	12 200	13 300	12 200	76,0
78,0	59,0	108,5	13 100	11 900	13 100	11 900	78,0
80,0	57,9	107,1	12 800	11 700	12 800	11 700	80,0
82,0	56,8	105,5	12 600	11 400	12 600	11 400	82,0
84,0	55,7	104,0	12 400	11 200	12 400	11 200	84,0
88,0	53,4	100,6	11 500	10 600	12 000	10 800	88,0
92,0	51,0	96,9	9 800	9 100	11 700	10 400	92,0
96,0	48,5	92,9	8 200	7 600	11 400	10 000	96,0
100,0	45,9	88,6	6 800	6 200	11 000	9 700	100,0
104,0	43,2	83,8	5 400	4 900	10 700	9 500	104,0
108,0	40,3	78,5	4 200	3 700	10 500	9 200	108,0
112,0	37,2	72,6			10 300	9 000	112,0
116,0	33,8	65,9			9 900	8 900	116,0
120,0	29,9	58,1			8 800	8 400	120,0
124,0							124,0
128,0							128,0

# MLC300 VPC-MAX S-2

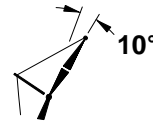
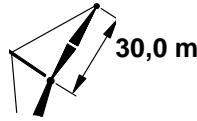
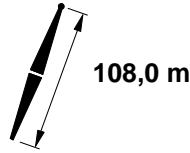

m	°	m	10,6 m		14,6 m		m
			0°		1°		
			kg	kg	kg	kg	
19,8	84,8	139,0	25 300		25 300		19,8
20,0	84,7	139,0	25 300		25 300		20,0
22,0	83,9	138,7	25 000		25 000		22,0
24,0	83,1	138,4	24 800	15 300	24 800	15 300	24,0
26,0	82,2	138,0	24 500	15 300	24 500	15 300	26,0
28,0	81,4	137,7	24 200	15 300	24 200	15 300	28,0
30,0	80,5	137,2	24 000	15 300	24 000	15 300	30,0
32,0	79,7	136,8	23 700	15 300	23 700	15 300	32,0
34,0	78,8	136,3	23 500	15 300	23 500	15 300	34,0
36,0	78,0	135,8	23 200	15 300	23 200	15 300	36,0
38,0	77,1	135,3	23 000	15 300	23 000	15 300	38,0
40,0	76,2	134,7	22 700	15 300	22 700	15 300	40,0
42,0	75,4	134,1	22 400	15 300	22 400	15 300	42,0
44,0	74,5	133,5	22 200	15 300	22 200	15 300	44,0
46,0	73,6	132,9	21 900	15 300	21 900	15 300	46,0
48,0	72,8	132,2	21 600	15 300	21 600	15 300	48,0
50,0	71,9	131,4	21 100	15 300	21 100	15 300	50,0
52,0	71,0	130,7	20 500	15 300	20 500	15 300	52,0
54,0	70,1	129,9	19 800	15 300	19 800	15 300	54,0
56,0	69,2	129,0	19 200	15 300	19 200	15 300	56,0
58,0	68,3	128,1	18 600	15 300	18 600	15 300	58,0
60,0	67,4	127,2	18 100	15 100	18 100	15 100	60,0
62,0	66,4	126,3	17 500	14 900	17 500	14 900	62,0
64,0	65,5	125,3	17 000	14 400	17 000	14 400	64,0
66,0	64,6	124,2	16 600	14 000	16 600	14 000	66,0
68,0	63,6	123,2	16 100	13 600	16 100	13 600	68,0
70,0	62,7	122,0	15 600	13 300	15 600	13 300	70,0
72,0	61,7	120,9	15 200	12 900	15 200	12 900	72,0
74,0	60,8	119,7	14 800	12 600	14 800	12 600	74,0
76,0	59,8	118,4	14 400	12 200	14 400	12 200	76,0
78,0	58,8	117,1	14 000	11 900	14 000	11 900	78,0
80,0	57,8	115,7	13 400	11 600	13 700	11 600	80,0
82,0	56,8	114,3	12 400	11 300	13 400	11 300	82,0
84,0	55,7	112,9	11 400	10 500	13 000	11 000	84,0
88,0	53,6	109,8	9 600	8 800	12 400	10 500	88,0
92,0	51,5	106,4	8 000	7 300	11 900	10 100	92,0
96,0	49,2	102,8	6 500	5 900	11 400	9 600	96,0
100,0	46,9	98,9	5 200	4 600	11 000	9 200	100,0
104,0	44,5	94,7	3 900		10 600	8 900	104,0
108,0	42,0	90,0			10 200	8 600	108,0
112,0	39,3	84,9			9 900	8 400	112,0
116,0	36,4	79,3			9 000	8 200	116,0
120,0	33,3	73,0			7 900	7 500	120,0
124,0	29,9	65,8			6 900	6 500	124,0
128,0	26,0	57,5			6 000	5 700	128,0
132,0	21,5	47,2			5 100	4 800	132,0

# MLC300 VPC-MAX S-2

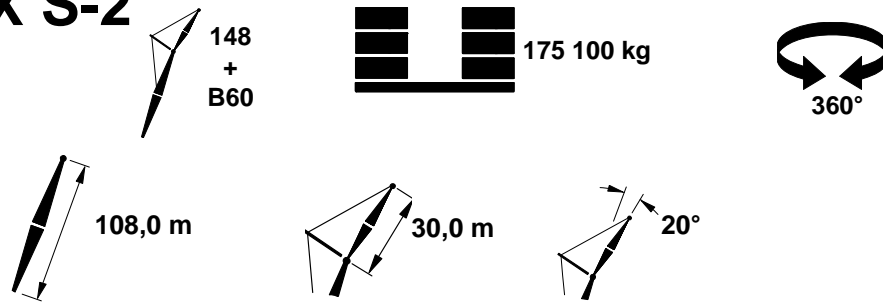

m	°	m	10,6 m		14,6 m		m
			0°	1°	0°	1°	
			kg	kg	kg	kg	
19,8							19,8
20,0							20,0
22,0							22,0
24,0							24,0
26,0	84,2	137,0	22 100		22 100		26,0
28,0	83,3	136,6	21 900	13 600	21 900	13 600	28,0
30,0	82,5	136,2	21 600	13 600	21 600	13 600	30,0
32,0	81,6	135,7	21 400	13 600	21 400	13 600	32,0
34,0	80,8	135,3	21 100	13 600	21 100	13 600	34,0
36,0	79,9	134,8	20 900	13 600	20 900	13 600	36,0
38,0	79,0	134,2	20 400	13 600	20 400	13 600	38,0
40,0	78,2	133,7	19 900	13 600	19 900	13 600	40,0
42,0	77,3	133,0	19 400	13 600	19 400	13 600	42,0
44,0	76,4	132,4	19 000	13 600	19 000	13 600	44,0
46,0	75,5	131,7	18 500	13 600	18 500	13 600	46,0
48,0	74,6	131,0	18 100	13 600	18 100	13 600	48,0
50,0	73,7	130,3	17 600	13 600	17 600	13 600	50,0
52,0	72,8	129,5	17 200	13 600	17 200	13 600	52,0
54,0	71,9	128,7	16 900	13 600	16 900	13 600	54,0
56,0	71,0	127,9	16 500	13 600	16 500	13 600	56,0
58,0	70,1	127,0	16 200	13 600	16 200	13 600	58,0
60,0	69,2	126,1	15 800	13 600	15 800	13 600	60,0
62,0	68,3	125,1	15 500	13 500	15 500	13 500	62,0
64,0	67,3	124,1	15 200	13 300	15 200	13 300	64,0
66,0	66,4	123,0	14 900	13 000	14 900	13 000	66,0
68,0	65,4	122,0	14 600	12 700	14 600	12 700	68,0
70,0	64,5	120,8	14 300	12 300	14 300	12 300	70,0
72,0	63,5	119,6	14 100	12 000	14 100	12 000	72,0
74,0	62,5	118,4	13 800	11 700	13 800	11 700	74,0
76,0	61,5	117,2	13 400	11 400	13 400	11 400	76,0
78,0	60,5	115,8	13 100	11 200	13 100	11 200	78,0
80,0	59,5	114,5	12 800	10 900	12 800	10 900	80,0
82,0	58,5	113,0	12 500	10 600	12 500	10 600	82,0
84,0	57,4	111,6	12 200	10 400	12 200	10 400	84,0
88,0	55,3	108,4	10 500	9 600	11 700	9 900	88,0
92,0	53,1	105,0	8 800	8 100	11 200	9 500	92,0
96,0	50,9	101,4	7 300	6 600	10 800	9 100	96,0
100,0	48,5	97,4	5 800	5 200	10 400	8 800	100,0
104,0	46,0	93,1	4 500	3 900	10 100	8 500	104,0
108,0	43,5	88,4	3 200		9 800	8 200	108,0
112,0	40,7	83,2			9 500	8 000	112,0
116,0	37,8	77,4			9 300	7 900	116,0
120,0	34,6	70,9			8 200	7 600	120,0
124,0	31,1	63,5			7 100	6 800	124,0
128,0	27,1	54,8			6 200	5 800	128,0
132,0							132,0

# MLC300 VPC-MAX S-2

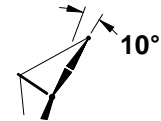
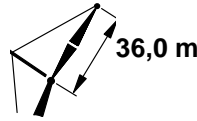
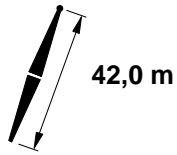
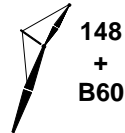

m	°	m	10,6 m			14,6 m			m
			0°			0°			
			kg	kg	kg	kg	kg	kg	
19,8	81,9	78,1	21 900	18 600c		21 900	18 600c		19,8
20,0	81,8	78,0	21 800	18 600c		21 800	18 600c		20,0
22,0	80,3	77,5	21 000	18 100b		21 000	18 100b		22,0
24,0	78,8	77,0	20 300	17 500	15 600c	20 300	17 500	15 300b	24,0
26,0	77,2	76,3	19 500	17 000	15 000	19 500	17 000	15 000	26,0
28,0	75,7	75,6	18 800	16 500	14 600	18 800	16 500	14 600	28,0
30,0	74,1	74,9	18 100	16 000	14 200	18 100	16 000	14 200	30,0
32,0	72,5	74,1	17 400	15 500	13 900	17 400	15 500	13 900	32,0
34,0	70,9	73,2	16 800	15 000	13 500	16 800	15 000	13 500	34,0
36,0	69,3	72,2	16 200	14 600	13 100	16 200	14 600	13 100	36,0
38,0	67,6	71,2	15 600	14 100	12 800	15 600	14 100	12 800	38,0
40,0	66,0	70,1	15 100	13 700	12 400	15 100	13 700	12 400	40,0
42,0	64,3	69,0	14 500	13 300	12 100	14 500	13 300	12 100	42,0
44,0	62,5	67,7	14 000	12 900	11 800	14 000	12 900	11 800	44,0
46,0	60,8	66,4	13 500	12 500	11 500	13 500	12 500	11 500	46,0
48,0	59,0	64,9	13 100	12 100	11 100	13 100	12 100	11 100	48,0
50,0	57,1	63,4	12 700	11 700	10 900	12 700	11 700	10 900	50,0
52,0	55,2	61,8	12 300	11 400	10 600	12 300	11 400	10 600	52,0
54,0	53,3	60,0	11 900	11 100	10 300	11 900	11 100	10 300	54,0
56,0	51,2	58,1	11 500	10 800	10 000	11 500	10 800	10 000	56,0
58,0	49,2	56,1	11 200	10 400	9 800	11 200	10 400	9 800	58,0
60,0	47,0	53,9	10 800	10 200	9 500	10 800	10 200	9 500	60,0
62,0	44,7	51,6	10 500	9 900	9 300	10 500	9 900	9 300	62,0
64,0	42,3	49,0	10 200	9 600	9 100	10 200	9 600	9 100	64,0
66,0	39,8	46,2	10 000	9 400	8 900	10 000	9 400	8 900	66,0
68,0	37,1	43,1	9 700	9 200	8 700	9 700	9 200	8 700	68,0
70,0	34,2	39,7	9 400	9 000	8 500	9 400	9 000	8 500	70,0
72,0	31,0	35,8	9 100	8 800	8 300	9 100	8 800	8 300	72,0
74,0	27,3	31,2	8 900	8 600	8 200	8 900	8 600	8 200	74,0
76,0	23,0	25,6	8 600	8 500	8 000	8 600	8 500	8 000	76,0



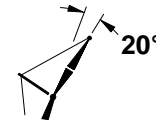
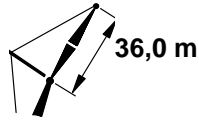
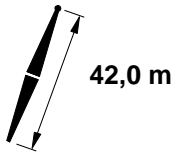
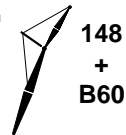



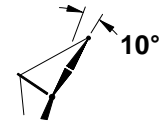
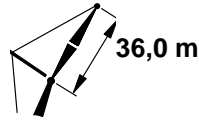
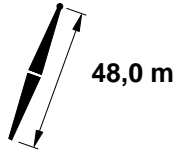
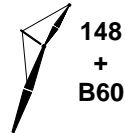

# MLC300 VPC-MAX S-2

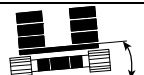
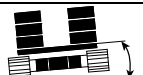
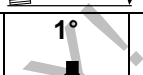

m	°	m	10,6 m			14,6 m			m			
			0°			1°				2°		
			kg	kg	kg	kg	kg	kg		kg	kg	kg
19,8											19,8	
20,0											20,0	
22,0											22,0	
24,0											24,0	
26,0	81,4	75,4	17 100	15 300b		17 100	15 300b				26,0	
28,0	79,8	74,7	16 500	14 800	13 300	16 500	14 800	13 300			28,0	
30,0	78,2	73,9	16 000	14 400	13 000	16 000	14 400	13 000			30,0	
32,0	76,6	73,1	15 300	14 000	12 700	15 300	14 000	12 700			32,0	
34,0	75,0	72,2	14 600	13 600	12 400	14 600	13 600	12 400			34,0	
36,0	73,3	71,2	14 000	13 200	12 100	14 000	13 200	12 100			36,0	
38,0	71,6	70,2	13 400	12 800	11 800	13 400	12 800	11 800			38,0	
40,0	69,9	69,1	12 800	12 400	11 500	12 800	12 400	11 500			40,0	
42,0	68,2	67,9	12 300	12 100	11 200	12 300	12 100	11 200			42,0	
44,0	66,5	66,6	11 800	11 700	10 900	11 800	11 700	10 900			44,0	
46,0	64,7	65,3	11 400	11 300	10 600	11 400	11 300	10 600			46,0	
48,0	62,8	63,8	10 900	10 900	10 400	10 900	10 900	10 400			48,0	
50,0	60,9	62,2	10 600	10 500	10 100	10 600	10 500	10 100			50,0	
52,0	59,0	60,6	10 200	10 100	9 900	10 200	10 100	9 900			52,0	
54,0	57,0	58,8	9 900	9 800	9 700	9 900	9 800	9 700			54,0	
56,0	55,0	56,9	9 500	9 500	9 400	9 500	9 500	9 400			56,0	
58,0	52,8	54,8	9 200	9 200	9 100	9 200	9 200	9 100			58,0	
60,0	50,6	52,6	9 000	8 900	8 800	9 000	8 900	8 800			60,0	
62,0	48,3	50,1	8 700	8 600	8 600	8 700	8 600	8 600			62,0	
64,0	45,8	47,5	8 500	8 400	8 400	8 500	8 400	8 400			64,0	
66,0	43,2	44,6	8 200	8 200	8 100	8 200	8 200	8 100			66,0	
68,0	40,4	41,4	8 000	8 000	7 900	8 000	8 000	7 900			68,0	
70,0	37,3	37,8	7 800	7 800	7 700	7 800	7 800	7 700			70,0	
72,0	33,9	33,6	7 700	7 600	7 600	7 700	7 600	7 600			72,0	
74,0	30,0	28,7	7 500			7 500					74,0	
76,0											76,0	

# MLC300 VPC-MAX S-2

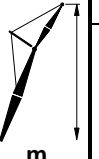
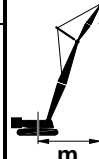

			 10,6 m			 14,6 m			
			 0°			 1°			 2°
			 kg			 kg			 kg
 m			 °			 m			 m
16,8	84,7	84,8	23 200 <sup>b</sup>			23 200 <sup>b</sup>			16,8
18,0	83,8	84,6	22 800			22 800			18,0
20,0	82,4	84,2	22 000	18 600 <sup>b</sup>	16 100 <sup>c</sup>	22 000	18 600 <sup>b</sup>	16 100 <sup>c</sup>	20,0
22,0	81,0	83,7	21 300	18 200	15 700 <sup>c</sup>	21 300	18 200	15 700 <sup>c</sup>	22,0
24,0	79,6	83,2	20 600	17 700	15 400	20 600	17 700	15 400	24,0
26,0	78,2	82,6	19 900	17 200	15 100	19 900	17 200	15 100	26,0
28,0	76,7	82,0	19 200	16 800	14 700	19 200	16 800	14 700	28,0
30,0	75,3	81,3	18 500	16 300	14 400	18 500	16 300	14 400	30,0
32,0	73,8	80,5	17 900	15 800	14 100	17 900	15 800	14 100	32,0
34,0	72,4	79,7	17 300	15 400	13 800	17 300	15 400	13 800	34,0
36,0	70,9	78,8	16 700	15 000	13 400	16 700	15 000	13 400	36,0
38,0	69,4	77,9	16 200	14 500	13 100	16 200	14 500	13 100	38,0
40,0	67,9	76,9	15 600	14 100	12 800	15 600	14 100	12 800	40,0
42,0	66,3	75,9	15 200	13 700	12 500	15 200	13 700	12 500	42,0
44,0	64,7	74,7	14 600	13 300	12 200	14 600	13 300	12 200	44,0
46,0	63,1	73,5	14 200	13 000	11 900	14 200	13 000	11 900	46,0
48,0	61,5	72,2	13 700	12 600	11 600	13 700	12 600	11 600	48,0
50,0	59,9	70,9	13 300	12 300	11 300	13 300	12 300	11 300	50,0
52,0	58,2	69,4	12 900	11 900	11 000	12 900	11 900	11 000	52,0
54,0	56,5	67,8	12 500	11 600	10 700	12 500	11 600	10 700	54,0
56,0	54,7	66,2	12 100	11 300	10 500	12 100	11 300	10 500	56,0
58,0	52,9	64,4	11 800	11 000	10 200	11 800	11 000	10 200	58,0
60,0	51,0	62,6	11 500	10 700	10 000	11 500	10 700	10 000	60,0
62,0	49,1	60,6	11 100	10 400	9 700	11 100	10 400	9 700	62,0
64,0	47,1	58,4	10 800	10 200	9 500	10 800	10 200	9 500	64,0
66,0	45,0	56,1	10 500	9 900	9 300	10 500	9 900	9 300	66,0
68,0	42,8	53,6	10 300	9 700	9 100	10 300	9 700	9 100	68,0
70,0	40,5	50,9	10 000	9 400	8 900	10 000	9 400	8 900	70,0
72,0	38,1	48,0	9 800	9 200	8 700	9 800	9 200	8 700	72,0
74,0	35,5	44,8	9 500	9 000	8 500	9 500	9 000	8 500	74,0
76,0	32,7	41,2	9 200	8 800	8 400	9 200	8 800	8 400	76,0
78,0	29,6	37,1	9 000	8 700	8 200	9 000	8 700	8 200	78,0
80,0	26,1	32,3	8 800	8 600	8 100	8 800	8 600	8 100	80,0
82,0	21,9	26,5	8 600	8 400	8 000	8 600	8 400	8 000	82,0

# MLC300 VPC-MAX S-2

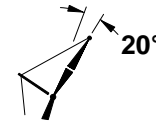
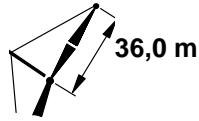
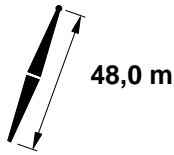
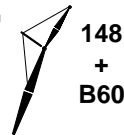

m	°	m	10,6 m			14,6 m			m
			0°			0°			
			kg	kg	kg	kg	kg	kg	
16,8									16,8
18,0									18,0
20,0									20,0
22,0									22,0
24,0	83,5	82,2	17 900			17 900			24,0
26,0	82,0	81,6	17 300	15 400	13 800	17 300	15 400	13 800	26,0
28,0	80,6	81,0	16 800	15 000	13 500	16 800	15 000	13 500	28,0
30,0	79,1	80,2	16 300	14 600	13 200	16 300	14 600	13 200	30,0
32,0	77,6	79,5	15 700	14 200	12 900	15 700	14 200	12 900	32,0
34,0	76,1	78,7	15 100	13 800	12 600	15 100	13 800	12 600	34,0
36,0	74,6	77,8	14 500	13 500	12 300	14 500	13 500	12 300	36,0
38,0	73,1	76,8	13 900	13 100	12 000	13 900	13 100	12 000	38,0
40,0	71,6	75,8	13 300	12 800	11 700	13 300	12 800	11 700	40,0
42,0	70,0	74,8	12 800	12 500	11 400	12 800	12 500	11 400	42,0
44,0	68,4	73,6	12 300	12 100	11 200	12 300	12 100	11 200	44,0
46,0	66,8	72,4	11 900	11 800	11 000	11 900	11 800	11 000	46,0
48,0	65,1	71,1	11 500	11 400	10 700	11 500	11 400	10 700	48,0
50,0	63,5	69,7	11 100	11 000	10 500	11 100	11 000	10 500	50,0
52,0	61,7	68,2	10 700	10 600	10 200	10 700	10 600	10 200	52,0
54,0	60,0	66,6	10 400	10 300	10 000	10 400	10 300	10 000	54,0
56,0	58,2	64,9	10 000	10 000	9 800	10 000	10 000	9 800	56,0
58,0	56,3	63,1	9 800	9 700	9 600	9 800	9 700	9 600	58,0
60,0	54,4	61,2	9 500	9 400	9 300	9 500	9 400	9 300	60,0
62,0	52,4	59,2	9 200	9 100	9 100	9 200	9 100	9 100	62,0
64,0	50,4	57,0	8 900	8 900	8 800	8 900	8 900	8 800	64,0
66,0	48,3	54,6	8 700	8 600	8 600	8 700	8 600	8 600	66,0
68,0	46,0	52,0	8 500	8 400	8 400	8 500	8 400	8 400	68,0
70,0	43,7	49,3	8 300	8 200	8 200	8 300	8 200	8 200	70,0
72,0	41,1	46,2	8 100	8 000	8 000	8 100	8 000	8 000	72,0
74,0	38,4	42,8	7 900	7 800	7 800	7 900	7 800	7 800	74,0
76,0	35,5	39,0	7 700	7 700	7 600	7 700	7 700	7 600	76,0
78,0	32,2	34,7	7 600	7 500	7 500	7 600	7 500	7 500	78,0
80,0									80,0
82,0									82,0



# MLC300 VPC-MAX S-2

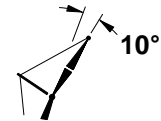
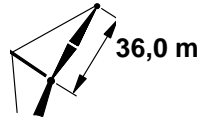
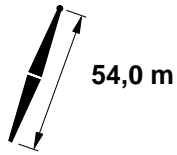

m	°	m	10,6 m			14,6 m			m			
			0°			1°				2°		
			kg	kg	kg	kg	kg	kg		kg	kg	kg
18,3	84,0	90,6	22 700			22 700			18,3			
20,0	82,9	90,3	22 100			22 100			20,0			
22,0	81,6	89,9	21 500	18 600 <sup>b</sup>	15 700 <sup>c</sup>	21 500	18 600 <sup>b</sup>	15 700 <sup>c</sup>	22,0			
24,0	80,3	89,4	20 800	17 800	15 400	20 800	17 800	15 400	24,0			
26,0	79,0	88,8	20 200	17 400	15 100	20 200	17 400	15 100	26,0			
28,0	77,7	88,2	19 500	17 000	14 900	19 500	17 000	14 900	28,0			
30,0	76,3	87,6	18 900	16 500	14 600	18 900	16 500	14 600	30,0			
32,0	75,0	86,9	18 300	16 100	14 300	18 300	16 100	14 300	32,0			
34,0	73,6	86,2	17 700	15 700	14 000	17 700	15 700	14 000	34,0			
36,0	72,2	85,4	17 200	15 300	13 700	17 200	15 300	13 700	36,0			
38,0	70,9	84,5	16 700	14 900	13 300	16 700	14 900	13 300	38,0			
40,0	69,5	83,6	16 200	14 500	13 100	16 200	14 500	13 100	40,0			
42,0	68,0	82,6	15 700	14 100	12 800	15 700	14 100	12 800	42,0			
44,0	66,6	81,6	15 200	13 800	12 500	15 200	13 800	12 500	44,0			
46,0	65,2	80,5	14 700	13 400	12 200	14 700	13 400	12 200	46,0			
48,0	63,7	79,3	14 300	13 100	11 900	14 300	13 100	11 900	48,0			
50,0	62,2	78,1	13 900	12 700	11 600	13 900	12 700	11 600	50,0			
52,0	60,7	76,7	13 500	12 400	11 400	13 500	12 400	11 400	52,0			
54,0	59,1	75,4	13 100	12 100	11 100	13 100	12 100	11 100	54,0			
56,0	57,5	73,9	12 700	11 800	10 900	12 700	11 800	10 900	56,0			
58,0	55,9	72,3	12 400	11 500	10 600	12 400	11 500	10 600	58,0			
60,0	54,3	70,7	12 000	11 200	10 400	12 000	11 200	10 400	60,0			
62,0	52,6	68,9	11 700	10 900	10 200	11 700	10 900	10 200	62,0			
64,0	50,8	67,0	11 400	10 700	9 900	11 400	10 700	9 900	64,0			
66,0	49,0	65,0	11 100	10 400	9 700	11 100	10 400	9 700	66,0			
68,0	47,2	62,9	10 800	10 200	9 500	10 800	10 200	9 500	68,0			
70,0	45,2	60,7	10 600	9 900	9 300	10 600	9 900	9 300	70,0			
72,0	43,2	58,2	10 300	9 700	9 100	10 300	9 700	9 100	72,0			
74,0	41,2	55,6	10 100	9 500	9 000	10 100	9 500	9 000	74,0			
76,0	39,0	52,8	9 800	9 300	8 800	9 800	9 300	8 800	76,0			
78,0	36,6	49,7	9 600	9 100	8 600	9 600	9 100	8 600	78,0			
80,0	34,1	46,3	9 400	8 900	8 400	9 400	8 900	8 400	80,0			
82,0	31,4	42,6	9 100	8 800	8 300	9 100	8 800	8 300	82,0			
84,0	28,4	38,3	8 900	8 600	8 200	8 900	8 600	8 200	84,0			
88,0	20,9	27,3	8 600	8 400	8 000	8 600	8 400	8 000	88,0			

# MLC300 VPC-MAX S-2



148  
+  
B60

175 100 kg

360°

54,0 m

36,0 m

20°

m	°	m	10,6 m			14,6 m			m			
			0°			1°				2°		
			kg	kg	kg	kg	kg	kg		kg	kg	
18,3									18,3			
20,0									20,0			
22,0									22,0			
24,0	83,9	88,3	18 000			18 000			24,0			
26,0	82,6	87,8	17 500	15 500	13 800	17 500	15 500	13 800	26,0			
28,0	81,2	87,2	17 000	15 100	13 500	17 000	15 100	13 500	28,0			
30,0	79,9	86,5	16 500	14 800	13 300	16 500	14 800	13 300	30,0			
32,0	78,5	85,8	16 000	14 400	13 000	16 000	14 400	13 000	32,0			
34,0	77,1	85,1	15 500	14 100	12 700	15 500	14 100	12 700	34,0			
36,0	75,8	84,3	14 900	13 700	12 500	14 900	13 700	12 500	36,0			
38,0	74,3	83,4	14 300	13 400	12 200	14 300	13 400	12 200	38,0			
40,0	72,9	82,5	13 800	13 100	11 900	13 800	13 100	11 900	40,0			
42,0	71,5	81,5	13 300	12 700	11 700	13 300	12 700	11 700	42,0			
44,0	70,0	80,4	12 800	12 400	11 500	12 800	12 400	11 500	44,0			
46,0	68,6	79,3	12 300	12 100	11 200	12 300	12 100	11 200	46,0			
48,0	67,1	78,1	11 900	11 800	11 000	11 900	11 800	11 000	48,0			
50,0	65,5	76,9	11 600	11 500	10 800	11 600	11 500	10 800	50,0			
52,0	64,0	75,5	11 200	11 100	10 500	11 200	11 100	10 500	52,0			
54,0	62,4	74,1	10 800	10 800	10 300	10 800	10 800	10 300	54,0			
56,0	60,8	72,6	10 500	10 400	10 100	10 500	10 400	10 100	56,0			
58,0	59,2	71,0	10 200	10 100	9 900	10 200	10 100	9 900	58,0			
60,0	57,5	69,3	9 900	9 800	9 700	9 900	9 800	9 700	60,0			
62,0	55,7	67,5	9 600	9 600	9 500	9 600	9 600	9 500	62,0			
64,0	54,0	65,6	9 400	9 300	9 200	9 400	9 300	9 200	64,0			
66,0	52,1	63,6	9 100	9 100	9 000	9 100	9 100	9 000	66,0			
68,0	50,2	61,4	8 900	8 900	8 800	8 900	8 900	8 800	68,0			
70,0	48,3	59,1	8 700	8 600	8 600	8 700	8 600	8 600	70,0			
72,0	46,2	56,6	8 500	8 400	8 400	8 500	8 400	8 400	72,0			
74,0	44,0	53,9	8 300	8 200	8 200	8 300	8 200	8 200	74,0			
76,0	41,8	51,0	8 100	8 100	8 000	8 100	8 100	8 000	76,0			
78,0	39,3	47,8	7 900	7 900	7 900	7 900	7 900	7 900	78,0			
80,0	36,7	44,2	7 800	7 700	7 700	7 800	7 700	7 700	80,0			
82,0	33,9	40,3	7 600	7 600	7 600	7 600	7 600	7 600	82,0			
84,0	30,7	35,7	7 500	7 500	7 500	7 500	7 500	7 500	84,0			
88,0									88,0			

# MLC300 VPC-MAX S-2

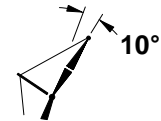
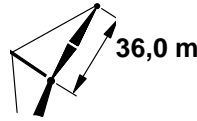
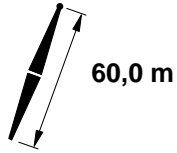

m	°	m	10,6 m			14,6 m			m
			0°			0°			
			kg	kg	kg	kg	kg	kg	
18,3	84,4	96,7	22 700			22 700			18,3
20,0	83,4	96,4	22 200	18 600		22 200	18 600		20,0
22,0	82,1	96,0	21 600	18 200	15 700 <sup>b</sup>	21 600	18 200	15 700 <sup>b</sup>	22,0
24,0	80,9	95,5	21 000	17 900	15 400	21 000	17 900	15 400	24,0
26,0	79,7	95,0	20 400	17 500	15 200	20 400	17 500	15 200	26,0
28,0	78,5	94,5	19 800	17 100	14 900	19 800	17 100	14 900	28,0
30,0	77,2	93,9	19 200	16 700	14 600	19 200	16 700	14 600	30,0
32,0	76,0	93,2	18 700	16 300	14 400	18 700	16 300	14 400	32,0
34,0	74,7	92,6	18 100	15 900	14 100	18 100	15 900	14 100	34,0
36,0	73,4	91,8	17 600	15 600	13 800	17 600	15 600	13 800	36,0
38,0	72,1	91,0	17 100	15 200	13 600	17 100	15 200	13 600	38,0
40,0	70,8	90,2	16 600	14 800	13 300	16 600	14 800	13 300	40,0
42,0	69,5	89,3	16 100	14 500	13 000	16 100	14 500	13 000	42,0
44,0	68,2	88,3	15 700	14 100	12 700	15 700	14 100	12 700	44,0
46,0	66,9	87,3	15 200	13 800	12 500	15 200	13 800	12 500	46,0
48,0	65,5	86,2	14 800	13 400	12 200	14 800	13 400	12 200	48,0
50,0	64,1	85,1	14 400	13 100	12 000	14 400	13 100	12 000	50,0
52,0	62,7	83,9	14 000	12 800	11 700	14 000	12 800	11 700	52,0
54,0	61,3	82,6	13 600	12 500	11 400	13 600	12 500	11 400	54,0
56,0	59,9	81,3	13 300	12 200	11 200	13 300	12 200	11 200	56,0
58,0	58,4	79,8	12 900	11 900	11 000	12 900	11 900	11 000	58,0
60,0	56,9	78,4	12 600	11 600	10 700	12 600	11 600	10 700	60,0
62,0	55,4	76,8	12 200	11 400	10 500	12 200	11 400	10 500	62,0
64,0	53,9	75,1	11 900	11 100	10 300	11 900	11 100	10 300	64,0
66,0	52,3	73,3	11 600	10 900	10 100	11 600	10 900	10 100	66,0
68,0	50,6	71,5	11 400	10 600	9 900	11 400	10 600	9 900	68,0
70,0	49,0	69,5	11 100	10 400	9 700	11 100	10 400	9 700	70,0
72,0	47,2	67,4	10 800	10 100	9 500	10 800	10 100	9 500	72,0
74,0	45,5	65,2	10 600	9 900	9 300	10 600	9 900	9 300	74,0
76,0	43,6	62,8	10 400	9 700	9 100	10 400	9 700	9 100	76,0
78,0	41,7	60,3	10 100	9 500	9 000	10 100	9 500	9 000	78,0
80,0	39,6	57,5	9 900	9 300	8 800	9 900	9 300	8 800	80,0
82,0	37,5	54,6	9 700	9 200	8 700	9 700	9 200	8 700	82,0
84,0	35,3	51,4	9 500	9 000	8 500	9 500	9 000	8 500	84,0
88,0	30,2	43,9	9 000	8 700	8 200	9 000	8 700	8 200	88,0
92,0	24,0	34,4	8 700	8 500	8 100	8 700	8 500	8 100	92,0

# MLC300 VPC-MAX S-2

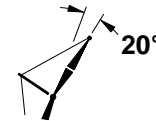
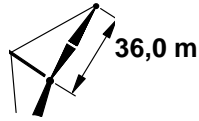
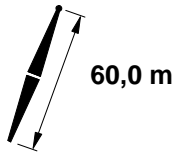

m	°	m	10,6 m			14,6 m			m
			0°	1°	2°	0°	1°	2°	
			kg	kg	kg	kg	kg	kg	
18,3									18,3
20,0									20,0
22,0									22,0
24,0									24,0
26,0	83,1	93,9	17 600	15 600		17 600	15 600		26,0
28,0	81,8	93,4	17 100	15 200	13 500	17 100	15 200	13 500	28,0
30,0	80,5	92,8	16 700	14 900	13 300	16 700	14 900	13 300	30,0
32,0	79,3	92,1	16 200	14 600	13 100	16 200	14 600	13 100	32,0
34,0	78,0	91,4	15 800	14 200	12 800	15 800	14 200	12 800	34,0
36,0	76,7	90,7	15 300	13 900	12 600	15 300	13 900	12 600	36,0
38,0	75,4	89,9	14 700	13 600	12 400	14 700	13 600	12 400	38,0
40,0	74,1	89,0	14 200	13 300	12 100	14 200	13 300	12 100	40,0
42,0	72,8	88,1	13 700	13 000	11 900	13 700	13 000	11 900	42,0
44,0	71,4	87,1	13 200	12 700	11 600	13 200	12 700	11 600	44,0
46,0	70,1	86,1	12 800	12 400	11 400	12 800	12 400	11 400	46,0
48,0	68,7	85,0	12 400	12 200	11 200	12 400	12 200	11 200	48,0
50,0	67,3	83,9	12 000	11 800	11 000	12 000	11 800	11 000	50,0
52,0	65,9	82,6	11 600	11 500	10 800	11 600	11 500	10 800	52,0
54,0	64,5	81,3	11 300	11 200	10 600	11 300	11 200	10 600	54,0
56,0	63,0	80,0	11 000	10 900	10 400	11 000	10 900	10 400	56,0
58,0	61,5	78,5	10 600	10 600	10 200	10 600	10 600	10 200	58,0
60,0	60,0	77,0	10 400	10 300	10 000	10 400	10 300	10 000	60,0
62,0	58,4	75,4	10 100	10 000	9 800	10 100	10 000	9 800	62,0
64,0	56,9	73,7	9 800	9 700	9 600	9 800	9 700	9 600	64,0
66,0	55,2	71,9	9 600	9 500	9 400	9 600	9 500	9 400	66,0
68,0	53,6	70,0	9 300	9 300	9 200	9 300	9 300	9 200	68,0
70,0	51,9	68,0	9 100	9 000	9 000	9 100	9 000	9 000	70,0
72,0	50,1	65,8	8 900	8 800	8 800	8 900	8 800	8 800	72,0
74,0	48,3	63,6	8 700	8 600	8 600	8 700	8 600	8 600	74,0
76,0	46,4	61,1	8 500	8 400	8 400	8 500	8 400	8 400	76,0
78,0	44,4	58,5	8 300	8 300	8 200	8 300	8 300	8 200	78,0
80,0	42,3	55,7	8 100	8 100	8 100	8 100	8 100	8 100	80,0
82,0	40,1	52,6	8 000	7 900	7 900	8 000	7 900	7 900	82,0
84,0	37,7	49,3	7 800	7 800	7 800	7 800	7 800	7 800	84,0
88,0	32,4	41,5	7 600	7 500	7 500	7 600	7 500	7 500	88,0
92,0									92,0

# MLC300 VPC-MAX S-2

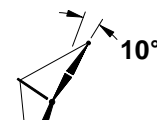
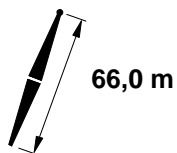

m	°	m	10,6 m			14,6 m			m
			0°	1°	2°	0°	1°	2°	
kg	kg	kg	kg	kg	kg	kg			
18,3	84,7	102,8	22 600			22 600			18,3
20,0	83,8	102,5	22 200	18 500		22 200	18 500		20,0
22,0	82,6	102,1	21 600	18 200	15 600 <sup>b</sup>	21 600	18 200	15 600 <sup>b</sup>	22,0
24,0	81,5	101,7	21 100	17 900	15 400	21 100	17 900	15 400	24,0
26,0	80,3	101,2	20 600	17 500	15 100	20 600	17 500	15 100	26,0
28,0	79,1	100,7	20 000	17 200	14 900	20 000	17 200	14 900	28,0
30,0	78,0	100,1	19 500	16 800	14 700	19 500	16 800	14 700	30,0
32,0	76,8	99,5	18 900	16 500	14 400	18 900	16 500	14 400	32,0
34,0	75,6	98,9	18 500	16 100	14 200	18 500	16 100	14 200	34,0
36,0	74,4	98,2	18 000	15 800	13 900	18 000	15 800	13 900	36,0
38,0	73,2	97,4	17 500	15 400	13 700	17 500	15 400	13 700	38,0
40,0	72,0	96,6	17 000	15 100	13 400	17 000	15 100	13 400	40,0
42,0	70,8	95,8	16 500	14 800	13 200	16 500	14 800	13 200	42,0
44,0	69,6	94,9	16 100	14 400	12 900	16 100	14 400	12 900	44,0
46,0	68,3	94,0	15 700	14 100	12 700	15 700	14 100	12 700	46,0
48,0	67,1	93,0	15 300	13 800	12 400	15 300	13 800	12 400	48,0
50,0	65,8	91,9	14 900	13 500	12 200	14 900	13 500	12 200	50,0
52,0	64,5	90,8	14 500	13 200	12 000	14 500	13 200	12 000	52,0
54,0	63,2	89,6	14 100	12 900	11 700	14 100	12 900	11 700	54,0
56,0	61,9	88,4	13 700	12 600	11 500	13 700	12 600	11 500	56,0
58,0	60,6	87,1	13 400	12 300	11 300	13 400	12 300	11 300	58,0
60,0	59,2	85,7	13 100	12 000	11 100	13 100	12 000	11 100	60,0
62,0	57,8	84,3	12 700	11 800	10 800	12 700	11 800	10 800	62,0
64,0	56,4	82,8	12 400	11 500	10 600	12 400	11 500	10 600	64,0
66,0	55,0	81,2	12 100	11 300	10 400	12 100	11 300	10 400	66,0
68,0	53,5	79,5	11 900	11 100	10 200	11 900	11 100	10 200	68,0
70,0	52,0	77,8	11 600	10 800	10 000	11 600	10 800	10 000	70,0
72,0	50,5	75,9	11 300	10 600	9 900	11 300	10 600	9 900	72,0
74,0	48,9	73,9	11 100	10 400	9 700	11 100	10 400	9 700	74,0
76,0	47,3	71,9	10 800	10 100	9 500	10 800	10 100	9 500	76,0
78,0	45,6	69,7	10 600	10 000	9 300	10 600	10 000	9 300	78,0
80,0	43,9	67,3	10 400	9 800	9 200	10 400	9 800	9 200	80,0
82,0	42,1	64,8	10 200	9 600	9 000	10 200	9 600	9 000	82,0
84,0	40,2	62,2	10 000	9 400	8 800	10 000	9 400	8 800	84,0
88,0	36,2	56,2	9 500	9 100	8 600	9 500	9 100	8 600	88,0
92,0	31,7	49,2	9 100	8 800	8 300	9 100	8 800	8 300	92,0
96,0	26,3	40,6	8 800	8 500	8 100	8 800	8 500	8 100	96,0
100,0	19,3	28,7	8 500	8 400	8 000	8 500	8 400	8 000	100,0

# MLC300 VPC-MAX S-2

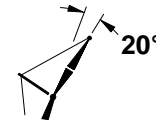
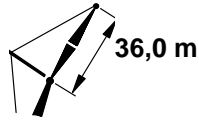
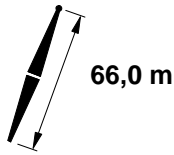
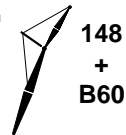

m	°	m	10,6 m			14,6 m			m
			0°			0°			
			kg	kg	kg	kg	kg	kg	
18,3									18,3
20,0									20,0
22,0									22,0
24,0									24,0
26,0	83,5	100,1	17 700	15 600		17 700	15 600		26,0
28,0	82,3	99,5	17 200	15 300	13 600	17 200	15 300	13 600	28,0
30,0	81,1	99,0	16 800	14 900	13 400	16 800	14 900	13 400	30,0
32,0	79,9	98,4	16 400	14 600	13 100	16 400	14 600	13 100	32,0
34,0	78,7	97,7	16 000	14 400	12 900	16 000	14 400	12 900	34,0
36,0	77,5	97,0	15 600	14 100	12 700	15 600	14 100	12 700	36,0
38,0	76,3	96,3	15 100	13 800	12 500	15 100	13 800	12 500	38,0
40,0	75,1	95,5	14 600	13 500	12 200	14 600	13 500	12 200	40,0
42,0	73,9	94,6	14 100	13 200	12 000	14 100	13 200	12 000	42,0
44,0	72,6	93,7	13 600	12 900	11 800	13 600	12 900	11 800	44,0
46,0	71,4	92,7	13 200	12 700	11 600	13 200	12 700	11 600	46,0
48,0	70,1	91,7	12 800	12 400	11 400	12 800	12 400	11 400	48,0
50,0	68,8	90,7	12 400	12 100	11 200	12 400	12 100	11 200	50,0
52,0	67,5	89,5	12 000	11 900	11 000	12 000	11 900	11 000	52,0
54,0	66,2	88,4	11 700	11 600	10 800	11 700	11 600	10 800	54,0
56,0	64,8	87,1	11 400	11 300	10 600	11 400	11 300	10 600	56,0
58,0	63,5	85,8	11 100	11 000	10 400	11 100	11 000	10 400	58,0
60,0	62,1	84,4	10 800	10 700	10 300	10 800	10 700	10 300	60,0
62,0	60,7	82,9	10 500	10 400	10 100	10 500	10 400	10 100	62,0
64,0	59,3	81,4	10 200	10 100	9 900	10 200	10 100	9 900	64,0
66,0	57,8	79,8	10 000	9 900	9 700	10 000	9 900	9 700	66,0
68,0	56,3	78,1	9 700	9 700	9 600	9 700	9 700	9 600	68,0
70,0	54,8	76,3	9 500	9 400	9 400	9 500	9 400	9 400	70,0
72,0	53,2	74,4	9 300	9 200	9 100	9 300	9 200	9 100	72,0
74,0	51,6	72,4	9 100	9 000	8 900	9 100	9 000	8 900	74,0
76,0	49,9	70,2	8 900	8 800	8 700	8 900	8 800	8 700	76,0
78,0	48,2	68,0	8 700	8 600	8 600	8 700	8 600	8 600	78,0
80,0	46,5	65,6	8 500	8 500	8 400	8 500	8 500	8 400	80,0
82,0	44,6	63,0	8 300	8 300	8 200	8 300	8 300	8 200	82,0
84,0	42,7	60,3	8 200	8 100	8 100	8 200	8 100	8 100	84,0
88,0	38,5	54,2	7 900	7 800	7 800	7 900	7 800	7 800	88,0
92,0	33,8	46,8	7 700	7 600	7 600	7 700	7 600	7 600	92,0
96,0	28,1	37,6	7 500			7 500			96,0
100,0									100,0

# MLC300 VPC-MAX S-2

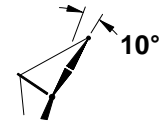
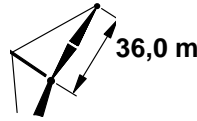
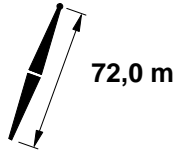
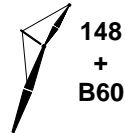

m	°	m	10,6 m			14,6 m			m			
			0°			1°				2°		
			kg	kg	kg	kg	kg	kg		kg	kg	kg
19,8	84,2	108,6	22 200			22 200				19,8		
20,0	84,1	108,6	22 100			22 100				20,0		
22,0	83,0	108,2	21 600	18 100		21 600	18 100			22,0		
24,0	81,9	107,8	21 100	17 800	15 300	21 100	17 800	15 300		24,0		
26,0	80,9	107,3	20 600	17 500	15 100	20 600	17 500	15 100		26,0		
28,0	79,8	106,9	20 100	17 200	14 900	20 100	17 200	14 900		28,0		
30,0	78,7	106,3	19 600	16 900	14 600	19 600	16 900	14 600		30,0		
32,0	77,6	105,8	19 200	16 500	14 400	19 200	16 500	14 400		32,0		
34,0	76,5	105,2	18 700	16 200	14 200	18 700	16 200	14 200		34,0		
36,0	75,3	104,5	18 200	15 900	14 000	18 200	15 900	14 000		36,0		
38,0	74,2	103,8	17 800	15 600	13 800	17 800	15 600	13 800		38,0		
40,0	73,1	103,1	17 300	15 300	13 500	17 300	15 300	13 500		40,0		
42,0	71,9	102,3	16 900	15 000	13 300	16 900	15 000	13 300		42,0		
44,0	70,8	101,4	16 500	14 700	13 100	16 500	14 700	13 100		44,0		
46,0	69,6	100,6	16 000	14 300	12 900	16 000	14 300	12 900		46,0		
48,0	68,5	99,6	15 700	14 000	12 600	15 700	14 000	12 600		48,0		
50,0	67,3	98,7	15 300	13 700	12 400	15 300	13 700	12 400		50,0		
52,0	66,1	97,6	14 900	13 400	12 200	14 900	13 400	12 200		52,0		
54,0	64,9	96,5	14 500	13 200	12 000	14 500	13 200	12 000		54,0		
56,0	63,7	95,4	14 200	12 900	11 700	14 200	12 900	11 700		56,0		
58,0	62,4	94,2	13 800	12 600	11 500	13 800	12 600	11 500		58,0		
60,0	61,2	92,9	13 500	12 400	11 300	13 500	12 400	11 300		60,0		
62,0	59,9	91,6	13 200	12 100	11 100	13 200	12 100	11 100		62,0		
64,0	58,6	90,2	12 900	11 900	10 900	12 900	11 900	10 900		64,0		
66,0	57,3	88,8	12 600	11 600	10 700	12 600	11 600	10 700		66,0		
68,0	56,0	87,3	12 300	11 400	10 500	12 300	11 400	10 500		68,0		
70,0	54,6	85,7	12 000	11 200	10 300	12 000	11 200	10 300		70,0		
72,0	53,2	84,0	11 800	11 000	10 200	11 800	11 000	10 200		72,0		
74,0	51,8	82,2	11 500	10 700	10 000	11 500	10 700	10 000		74,0		
76,0	50,4	80,4	11 300	10 500	9 800	11 300	10 500	9 800		76,0		
78,0	48,9	78,4	11 100	10 300	9 600	11 100	10 300	9 600		78,0		
80,0	47,3	76,3	10 800	10 100	9 500	10 800	10 100	9 500		80,0		
82,0	45,8	74,2	10 600	9 900	9 300	10 600	9 900	9 300		82,0		
84,0	44,2	71,9	10 400	9 800	9 200	10 400	9 800	9 200		84,0		
88,0	40,7	66,8	10 000	9 400	8 900	10 000	9 400	8 900		88,0		
92,0	37,0	61,1	9 600	9 100	8 600	9 600	9 100	8 600		92,0		
96,0	32,9	54,5	9 200	8 800	8 400	9 200	8 800	8 400		96,0		
100,0	28,2	46,5	8 900	8 600	8 100	8 900	8 600	8 100		100,0		
104,0	22,3	36,2	8 600			8 600				104,0		

# MLC300 VPC-MAX S-2

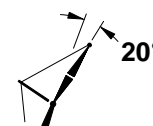
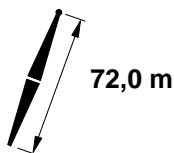

m	°	m	10,6 m			14,6 m			m
			0°	1°	2°	0°	1°	2°	
			kg	kg	kg	kg	kg	kg	
19,8									19,8
20,0									20,0
22,0									22,0
24,0									24,0
26,0	83,9	106,2	17 700	15 500		17 700	15 500		26,0
28,0	82,8	105,7	17 300	15 300		17 300	15 300		28,0
30,0	81,6	105,2	16 900	15 000	13 300	16 900	15 000	13 300	30,0
32,0	80,5	104,6	16 500	14 700	13 100	16 500	14 700	13 100	32,0
34,0	79,4	104,0	16 100	14 400	12 900	16 100	14 400	12 900	34,0
36,0	78,3	103,3	15 800	14 200	12 700	15 800	14 200	12 700	36,0
38,0	77,1	102,6	15 400	13 900	12 500	15 400	13 900	12 500	38,0
40,0	76,0	101,9	14 900	13 600	12 300	14 900	13 600	12 300	40,0
42,0	74,8	101,1	14 500	13 400	12 100	14 500	13 400	12 100	42,0
44,0	73,7	100,2	14 000	13 100	11 900	14 000	13 100	11 900	44,0
46,0	72,5	99,3	13 600	12 900	11 700	13 600	12 900	11 700	46,0
48,0	71,3	98,4	13 200	12 600	11 600	13 200	12 600	11 600	48,0
50,0	70,1	97,4	12 800	12 400	11 400	12 800	12 400	11 400	50,0
52,0	68,9	96,4	12 400	12 100	11 200	12 400	12 100	11 200	52,0
54,0	67,7	95,3	12 100	11 900	11 000	12 100	11 900	11 000	54,0
56,0	66,4	94,1	11 700	11 600	10 800	11 700	11 600	10 800	56,0
58,0	65,2	92,9	11 400	11 300	10 600	11 400	11 300	10 600	58,0
60,0	63,9	91,6	11 200	11 100	10 500	11 200	11 100	10 500	60,0
62,0	62,6	90,3	10 900	10 800	10 300	10 900	10 800	10 300	62,0
64,0	61,3	88,9	10 600	10 500	10 100	10 600	10 500	10 100	64,0
66,0	60,0	87,4	10 300	10 300	10 000	10 300	10 300	10 000	66,0
68,0	58,6	85,8	10 100	10 000	9 800	10 100	10 000	9 800	68,0
70,0	57,2	84,2	9 900	9 800	9 700	9 900	9 800	9 700	70,0
72,0	55,8	82,5	9 600	9 600	9 500	9 600	9 600	9 500	72,0
74,0	54,4	80,7	9 400	9 400	9 300	9 400	9 400	9 300	74,0
76,0	52,9	78,8	9 200	9 200	9 100	9 200	9 200	9 100	76,0
78,0	51,4	76,8	9 100	9 000	8 900	9 100	9 000	8 900	78,0
80,0	49,8	74,7	8 900	8 800	8 700	8 900	8 800	8 700	80,0
82,0	48,2	72,5	8 700	8 600	8 600	8 700	8 600	8 600	82,0
84,0	46,6	70,1	8 500	8 500	8 400	8 500	8 500	8 400	84,0
88,0	43,1	64,9	8 200	8 200	8 100	8 200	8 200	8 100	88,0
92,0	39,2	59,0	7 900	7 900	7 800	7 900	7 900	7 800	92,0
96,0	35,0	52,1	7 700	7 600	7 600	7 700	7 600	7 600	96,0
100,0	29,9	43,7	7 500	7 500	7 400	7 500	7 500	7 400	100,0
104,0									104,0



# MLC300 VPC-MAX S-2

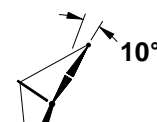
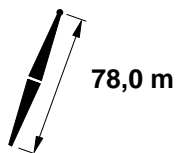

m	°	m	10,6 m			14,6 m			m			
			0°			1°				2°		
			kg	kg	kg	kg	kg	kg		kg	kg	kg
19,8	84,5	114,7	22 000			22 000				19,8		
20,0	84,4	114,6	21 900			21 900				20,0		
22,0	83,4	114,3	21 500	17 900		21 500	17 900			22,0		
24,0	82,4	113,9	21 000	17 600	14 300	21 000	17 600	14 300		24,0		
26,0	81,4	113,5	20 600	17 300	14 100	20 600	17 300	14 100		26,0		
28,0	80,3	113,0	20 100	17 100	13 900	20 100	17 100	13 900		28,0		
30,0	79,3	112,5	19 700	16 800	13 700	19 700	16 800	13 700		30,0		
32,0	78,2	112,0	19 200	16 500	13 500	19 200	16 500	13 500		32,0		
34,0	77,2	111,4	18 800	16 200	13 300	18 800	16 200	13 300		34,0		
36,0	76,1	110,8	18 400	15 900	13 100	18 400	15 900	13 100		36,0		
38,0	75,1	110,2	17 900	15 700	12 900	17 900	15 700	12 900		38,0		
40,0	74,0	109,5	17 600	15 300	12 700	17 600	15 300	12 700		40,0		
42,0	72,9	108,7	17 100	15 100	12 500	17 100	15 100	12 500		42,0		
44,0	71,9	107,9	16 700	14 800	12 300	16 700	14 800	12 300		44,0		
46,0	70,8	107,1	16 300	14 500	12 100	16 300	14 500	12 100		46,0		
48,0	69,7	106,2	15 900	14 200	11 900	15 900	14 200	11 900		48,0		
50,0	68,6	105,3	15 600	13 900	11 700	15 600	13 900	11 700		50,0		
52,0	67,5	104,4	15 200	13 700	11 500	15 200	13 700	11 500		52,0		
54,0	66,3	103,3	14 900	13 400	11 300	14 900	13 400	11 300		54,0		
56,0	65,2	102,3	14 500	13 100	11 100	14 500	13 100	11 100		56,0		
58,0	64,0	101,2	14 200	12 900	10 900	14 200	12 900	10 900		58,0		
60,0	62,9	100,0	13 900	12 600	10 700	13 900	12 600	10 700		60,0		
62,0	61,7	98,8	13 600	12 400	10 500	13 600	12 400	10 500		62,0		
64,0	60,5	97,5	13 300	12 200	10 400	13 300	12 200	10 400		64,0		
66,0	59,3	96,2	13 000	11 900	10 200	13 000	11 900	10 200		66,0		
68,0	58,1	94,8	12 700	11 700	10 000	12 700	11 700	10 000		68,0		
70,0	56,8	93,3	12 500	11 500	9 900	12 500	11 500	9 900		70,0		
72,0	55,6	91,7	12 200	11 300	9 700	12 200	11 300	9 700		72,0		
74,0	54,3	90,1	11 900	11 100	9 500	11 900	11 100	9 500		74,0		
76,0	52,9	88,4	11 700	10 900	9 400	11 700	10 900	9 400		76,0		
78,0	51,6	86,7	11 500	10 700	9 200	11 500	10 700	9 200		78,0		
80,0	50,2	84,8	11 200	10 500	9 100	11 200	10 500	9 100		80,0		
82,0	48,8	82,9	11 000	10 300	8 900	11 000	10 300	8 900		82,0		
84,0	47,4	80,8	10 800	10 100	8 800	10 800	10 100	8 800		84,0		
88,0	44,4	76,4	10 400	9 800	8 500	10 400	9 800	8 500		88,0		
92,0	41,2	71,5	10 100	9 400	8 300	10 100	9 400	8 300		92,0		
96,0	37,8	65,9	9 700	9 200	8 000	9 700	9 200	8 000		96,0		
100,0	34,0	59,5	9 300	8 900	7 800	9 300	8 900	7 800		100,0		
104,0	29,7	52,1	8 600	8 300	7 600	9 000	8 700	7 700		104,0		
108,0	24,6	42,8	7 300	7 100	6 900	8 700	8 500	7 500		108,0		

# MLC300 VPC-MAX S-2

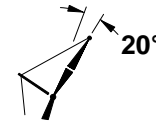
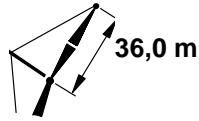
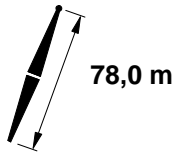
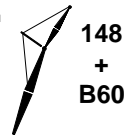

m	°	m	10,6 m			14,6 m			m
			0°			0°			
			kg	kg	kg	kg	kg	kg	
19,8									19,8
20,0									20,0
22,0									22,0
24,0									24,0
26,0	84,2	112,3	17 700			17 700			26,0
28,0	83,2	111,8	17 300	14 000		17 300	14 000		28,0
30,0	82,1	111,3	17 000	13 700	12 300	17 000	13 700	12 300	30,0
32,0	81,0	110,8	16 600	13 500	12 200	16 600	13 500	12 200	32,0
34,0	80,0	110,2	16 200	13 300	12 000	16 200	13 300	12 000	34,0
36,0	78,9	109,6	15 900	13 000	11 800	15 900	13 000	11 800	36,0
38,0	77,9	108,9	15 500	12 800	11 700	15 500	12 800	11 700	38,0
40,0	76,8	108,2	15 200	12 600	11 500	15 200	12 600	11 500	40,0
42,0	75,7	107,5	14 700	12 300	11 300	14 700	12 300	11 300	42,0
44,0	74,6	106,7	14 300	12 100	11 100	14 300	12 100	11 100	44,0
46,0	73,5	105,9	13 900	11 900	11 000	13 900	11 900	11 000	46,0
48,0	72,4	105,0	13 500	11 700	10 800	13 500	11 700	10 800	48,0
50,0	71,3	104,0	13 100	11 500	10 600	13 100	11 500	10 600	50,0
52,0	70,1	103,1	12 700	11 300	10 400	12 700	11 300	10 400	52,0
54,0	69,0	102,0	12 400	11 100	10 300	12 400	11 100	10 300	54,0
56,0	67,8	101,0	12 100	10 900	10 100	12 100	10 900	10 100	56,0
58,0	66,7	99,8	11 800	10 700	10 000	11 800	10 700	10 000	58,0
60,0	65,5	98,7	11 500	10 500	9 800	11 500	10 500	9 800	60,0
62,0	64,3	97,4	11 200	10 400	9 700	11 200	10 400	9 700	62,0
64,0	63,1	96,1	10 900	10 200	9 500	10 900	10 200	9 500	64,0
66,0	61,9	94,8	10 700	10 000	9 400	10 700	10 000	9 400	66,0
68,0	60,6	93,3	10 400	9 900	9 300	10 400	9 900	9 300	68,0
70,0	59,4	91,8	10 200	9 700	9 100	10 200	9 700	9 100	70,0
72,0	58,1	90,3	10 000	9 500	9 000	10 000	9 500	9 000	72,0
74,0	56,7	88,6	9 800	9 400	8 900	9 800	9 400	8 900	74,0
76,0	55,4	86,9	9 600	9 300	8 700	9 600	9 300	8 700	76,0
78,0	54,0	85,1	9 400	9 100	8 600	9 400	9 100	8 600	78,0
80,0	52,6	83,2	9 200	9 000	8 500	9 200	9 000	8 500	80,0
82,0	51,2	81,2	9 000	8 900	8 400	9 000	8 900	8 400	82,0
84,0	49,7	79,2	8 800	8 700	8 300	8 800	8 700	8 300	84,0
88,0	46,7	74,6	8 500	8 500	8 100	8 500	8 500	8 100	88,0
92,0	43,4	69,6	8 200	8 200	7 900	8 200	8 200	7 900	92,0
96,0	39,9	63,8	8 000	7 900	7 800	8 000	7 900	7 800	96,0
100,0	35,9	57,2	7 700	7 700	7 600	7 700	7 700	7 600	100,0
104,0	31,4	49,4	7 500	7 500	7 500	7 500	7 500	7 500	104,0
108,0									108,0

# MLC300 VPC-MAX S-2

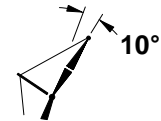
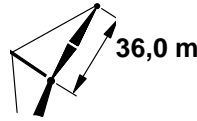
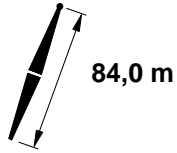

m	°	m	10,6 m			14,6 m			m
			0°			0°			
			kg	kg	kg	kg	kg	kg	
19,8	84,8	120,7	21 800			21 800			19,8
20,0	84,7	120,7	21 700			21 700			20,0
22,0	83,7	120,4	21 400			21 400			22,0
24,0	82,8	120,0	21 000	17 500		21 000	17 500		24,0
26,0	81,8	119,6	20 600	17 200	13 900	20 600	17 200	13 900	26,0
28,0	80,8	119,2	20 200	17 000	13 800	20 200	17 000	13 800	28,0
30,0	79,8	118,7	19 700	16 700	13 600	19 700	16 700	13 600	30,0
32,0	78,8	118,2	19 300	16 500	13 400	19 300	16 500	13 400	32,0
34,0	77,9	117,7	18 900	16 200	13 200	18 900	16 200	13 200	34,0
36,0	76,9	117,1	18 500	15 900	13 100	18 500	15 900	13 100	36,0
38,0	75,9	116,5	18 100	15 700	12 900	18 100	15 700	12 900	38,0
40,0	74,9	115,8	17 700	15 400	12 700	17 700	15 400	12 700	40,0
42,0	73,8	115,1	17 300	15 200	12 500	17 300	15 200	12 500	42,0
44,0	72,8	114,4	17 000	14 900	12 300	17 000	14 900	12 300	44,0
46,0	71,8	113,6	16 600	14 600	12 100	16 600	14 600	12 100	46,0
48,0	70,8	112,8	16 200	14 400	12 000	16 200	14 400	12 000	48,0
50,0	69,7	111,9	15 900	14 100	11 800	15 900	14 100	11 800	50,0
52,0	68,7	111,0	15 500	13 900	11 600	15 500	13 900	11 600	52,0
54,0	67,6	110,1	15 200	13 600	11 400	15 200	13 600	11 400	54,0
56,0	66,6	109,1	14 900	13 400	11 200	14 900	13 400	11 200	56,0
58,0	65,5	108,0	14 600	13 100	11 100	14 600	13 100	11 100	58,0
60,0	64,4	106,9	14 200	12 900	10 900	14 200	12 900	10 900	60,0
62,0	63,3	105,8	13 900	12 700	10 700	13 900	12 700	10 700	62,0
64,0	62,2	104,6	13 700	12 400	10 500	13 700	12 400	10 500	64,0
66,0	61,1	103,3	13 400	12 200	10 400	13 400	12 200	10 400	66,0
68,0	59,9	102,0	13 100	12 000	10 200	13 100	12 000	10 200	68,0
70,0	58,8	100,7	12 800	11 800	10 100	12 800	11 800	10 100	70,0
72,0	57,6	99,3	12 600	11 600	9 900	12 600	11 600	9 900	72,0
74,0	56,4	97,8	12 300	11 400	9 800	12 300	11 400	9 800	74,0
76,0	55,2	96,2	12 100	11 200	9 600	12 100	11 200	9 600	76,0
78,0	54,0	94,6	11 800	11 000	9 500	11 800	11 000	9 500	78,0
80,0	52,7	92,9	11 600	10 800	9 300	11 600	10 800	9 300	80,0
82,0	51,4	91,1	11 400	10 600	9 200	11 400	10 600	9 200	82,0
84,0	50,1	89,3	11 200	10 400	9 000	11 200	10 400	9 000	84,0
88,0	47,4	85,3	10 800	10 100	8 800	10 800	10 100	8 800	88,0
92,0	44,6	80,9	10 400	9 800	8 500	10 400	9 800	8 500	92,0
96,0	41,6	76,1	10 100	9 400	8 300	10 100	9 500	8 300	96,0
100,0	38,4	70,7	8 900	8 500	7 900	9 800	9 200	8 100	100,0
104,0	34,9	64,5	7 600	7 200	6 900	9 400	8 900	7 900	104,0
108,0	31,0	57,4	6 400	6 100	5 800	9 100	8 700	7 700	108,0
112,0	26,5	48,9	5 200	5 000	4 700	8 800	8 500	7 500	112,0
116,0	21,0	38,0	4 100			8 600			116,0

# MLC300 VPC-MAX S-2

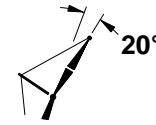
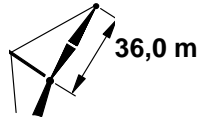
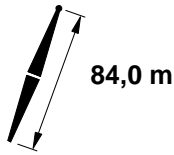
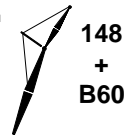

m	°	m	10,6 m			14,6 m			m			
			0°			1°				2°		
			kg	kg	kg	kg	kg	kg		kg	kg	kg
19,8										19,8		
20,0										20,0		
22,0										22,0		
24,0										24,0		
26,0	84,5	118,4	17 700			17 700				26,0		
28,0	83,5	118,0	17 300	13 900		17 300	13 900			28,0		
30,0	82,5	117,5	17 000	13 700		17 000	13 700			30,0		
32,0	81,5	117,0	16 700	13 500	12 100	16 700	13 500	12 100		32,0		
34,0	80,5	116,4	16 300	13 300	12 000	16 300	13 300	12 000		34,0		
36,0	79,5	115,8	16 000	13 100	11 800	16 000	13 100	11 800		36,0		
38,0	78,5	115,2	15 700	12 900	11 700	15 700	12 900	11 700		38,0		
40,0	77,5	114,6	15 400	12 600	11 500	15 400	12 600	11 500		40,0		
42,0	76,5	113,8	15 000	12 400	11 300	15 000	12 400	11 300		42,0		
44,0	75,4	113,1	14 600	12 200	11 200	14 600	12 200	11 200		44,0		
46,0	74,4	112,3	14 200	12 000	11 000	14 200	12 000	11 000		46,0		
48,0	73,3	111,5	13 800	11 800	10 900	13 800	11 800	10 900		48,0		
50,0	72,3	110,6	13 400	11 600	10 700	13 400	11 600	10 700		50,0		
52,0	71,2	109,7	13 000	11 400	10 500	13 000	11 400	10 500		52,0		
54,0	70,2	108,7	12 700	11 300	10 400	12 700	11 300	10 400		54,0		
56,0	69,1	107,7	12 400	11 100	10 300	12 400	11 100	10 300		56,0		
58,0	68,0	106,7	12 100	10 900	10 100	12 100	10 900	10 100		58,0		
60,0	66,9	105,6	11 800	10 700	10 000	11 800	10 700	10 000		60,0		
62,0	65,8	104,4	11 500	10 500	9 800	11 500	10 500	9 800		62,0		
64,0	64,6	103,2	11 200	10 400	9 700	11 200	10 400	9 700		64,0		
66,0	63,5	101,9	11 000	10 200	9 600	11 000	10 200	9 600		66,0		
68,0	62,4	100,6	10 800	10 100	9 400	10 800	10 100	9 400		68,0		
70,0	61,2	99,2	10 500	9 900	9 300	10 500	9 900	9 300		70,0		
72,0	60,0	97,8	10 300	9 800	9 200	10 300	9 800	9 200		72,0		
74,0	58,8	96,3	10 100	9 600	9 000	10 100	9 600	9 000		74,0		
76,0	57,6	94,7	9 900	9 500	8 900	9 900	9 500	8 900		76,0		
78,0	56,3	93,1	9 700	9 300	8 800	9 700	9 300	8 800		78,0		
80,0	55,0	91,3	9 500	9 200	8 700	9 500	9 200	8 700		80,0		
82,0	53,7	89,5	9 300	9 100	8 600	9 300	9 100	8 600		82,0		
84,0	52,4	87,7	9 100	9 000	8 500	9 100	9 000	8 500		84,0		
88,0	49,7	83,6	8 800	8 700	8 300	8 800	8 700	8 300		88,0		
92,0	46,8	79,1	8 500	8 500	8 100	8 500	8 500	8 100		92,0		
96,0	43,7	74,2	8 200	8 200	7 900	8 200	8 200	7 900		96,0		
100,0	40,4	68,6	8 000	7 900	7 800	8 000	7 900	7 800		100,0		
104,0	36,8	62,2	7 800	7 600	7 300	7 800	7 700	7 700		104,0		
108,0	32,7	54,8	6 700	6 400	6 100	7 600	7 600	7 500		108,0		
112,0	27,9	45,8	5 500	5 200	4 900	7 400	7 400	7 400		112,0		
116,0										116,0		

# MLC300 VPC-MAX S-2

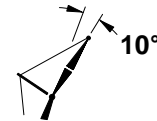
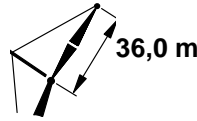
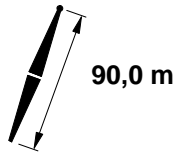

m	°	m	10,6 m			14,6 m			m			
			0°			1°				2°		
			kg	kg	kg	kg	kg	kg		kg	kg	
21,3	84,4	126,6	21 200			21 200			21,3			
22,0	84,0	126,5	21 100			21 100			22,0			
24,0	83,1	126,1	20 700	17 200		20 700	17 200		24,0			
26,0	82,2	125,7	20 300	17 000	13 700	20 300	17 000	13 700	26,0			
28,0	81,3	125,3	20 000	16 700	13 600	20 000	16 700	13 600	28,0			
30,0	80,3	124,9	19 600	16 500	13 400	19 600	16 500	13 400	30,0			
32,0	79,4	124,4	19 300	16 300	13 300	19 300	16 300	13 300	32,0			
34,0	78,5	123,9	18 900	16 100	13 100	18 900	16 100	13 100	34,0			
36,0	77,5	123,3	18 500	15 900	12 900	18 500	15 900	12 900	36,0			
38,0	76,6	122,7	18 200	15 600	12 800	18 200	15 600	12 800	38,0			
40,0	75,6	122,1	17 800	15 400	12 600	17 800	15 400	12 600	40,0			
42,0	74,7	121,5	17 400	15 100	12 500	17 400	15 100	12 500	42,0			
44,0	73,7	120,8	17 100	14 900	12 300	17 100	14 900	12 300	44,0			
46,0	72,7	120,0	16 700	14 700	12 100	16 700	14 700	12 100	46,0			
48,0	71,7	119,2	16 400	14 400	12 000	16 400	14 400	12 000	48,0			
50,0	70,8	118,4	16 100	14 200	11 800	16 100	14 200	11 800	50,0			
52,0	69,8	117,6	15 700	14 000	11 700	15 700	14 000	11 700	52,0			
54,0	68,8	116,7	15 400	13 700	11 500	15 400	13 700	11 500	54,0			
56,0	67,8	115,7	15 100	13 500	11 300	15 100	13 500	11 300	56,0			
58,0	66,8	114,8	14 800	13 300	11 200	14 800	13 300	11 200	58,0			
60,0	65,7	113,7	14 500	13 000	11 000	14 500	13 000	11 000	60,0			
62,0	64,7	112,7	14 200	12 800	10 800	14 200	12 800	10 800	62,0			
64,0	63,7	111,5	14 000	12 600	10 700	14 000	12 600	10 700	64,0			
66,0	62,6	110,4	13 700	12 400	10 500	13 700	12 400	10 500	66,0			
68,0	61,5	109,2	13 400	12 200	10 400	13 400	12 200	10 400	68,0			
70,0	60,5	107,9	13 200	12 000	10 200	13 200	12 000	10 200	70,0			
72,0	59,4	106,6	12 900	11 800	10 000	12 900	11 800	10 000	72,0			
74,0	58,3	105,2	12 700	11 600	9 900	12 700	11 600	9 900	74,0			
76,0	57,1	103,8	12 400	11 400	9 800	12 400	11 400	9 800	76,0			
78,0	56,0	102,3	12 200	11 200	9 600	12 200	11 200	9 600	78,0			
80,0	54,9	100,7	12 000	11 000	9 500	12 000	11 000	9 500	80,0			
82,0	53,7	99,1	11 700	10 900	9 400	11 700	10 900	9 400	82,0			
84,0	52,5	97,4	11 500	10 700	9 200	11 500	10 700	9 200	84,0			
88,0	50,0	93,8	11 100	10 400	9 000	11 100	10 400	9 000	88,0			
92,0	47,5	89,8	10 800	10 000	8 700	10 800	10 000	8 700	92,0			
96,0	44,8	85,5	9 900	9 300	8 500	10 400	9 700	8 500	96,0			
100,0	42,0	80,7	8 500	8 000	7 500	10 100	9 500	8 300	100,0			
104,0	38,9	75,4	7 200	6 800	6 400	9 800	9 200	8 100	104,0			
108,0	35,7	69,5	6 000	5 600	5 300	9 500	9 000	7 900	108,0			
112,0	32,1	62,7	4 900	4 500	4 200	9 200	8 800	7 700	112,0			
116,0	28,0	54,7	3 800			8 900	8 600	7 600	116,0			
120,0	23,2	44,9				8 600	8 500	7 500	120,0			

# MLC300 VPC-MAX S-2

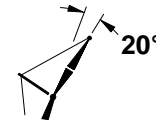
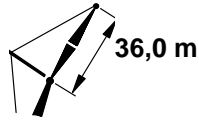
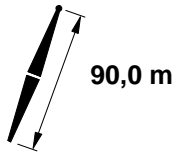
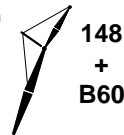

m	°	m	10,6 m			14,6 m			m
			0°	1°	2°	0°	1°	2°	
			kg	kg	kg	kg	kg	kg	
21,3									21,3
22,0									22,0
24,0									24,0
26,0	84,8	124,5	17 600			17 600			26,0
28,0	83,8	124,1	17 300			17 300			28,0
30,0	82,9	123,6	17 000	13 600		17 000	13 600		30,0
32,0	81,9	123,1	16 600	13 400	11 900	16 600	13 400	11 900	32,0
34,0	81,0	122,6	16 300	13 300	11 800	16 300	13 300	11 800	34,0
36,0	80,0	122,1	16 000	13 000	11 700	16 000	13 000	11 700	36,0
38,0	79,1	121,5	15 700	12 800	11 600	15 700	12 800	11 600	38,0
40,0	78,1	120,8	15 400	12 700	11 400	15 400	12 700	11 400	40,0
42,0	77,1	120,2	15 100	12 500	11 300	15 100	12 500	11 300	42,0
44,0	76,2	119,5	14 800	12 300	11 200	14 800	12 300	11 200	44,0
46,0	75,2	118,7	14 400	12 100	11 000	14 400	12 100	11 000	46,0
48,0	74,2	117,9	14 000	11 900	10 900	14 000	11 900	10 900	48,0
50,0	73,2	117,1	13 600	11 700	10 700	13 600	11 700	10 700	50,0
52,0	72,2	116,3	13 300	11 500	10 600	13 300	11 500	10 600	52,0
54,0	71,2	115,4	13 000	11 400	10 500	13 000	11 400	10 500	54,0
56,0	70,2	114,4	12 700	11 200	10 300	12 700	11 200	10 300	56,0
58,0	69,2	113,4	12 400	11 000	10 200	12 400	11 000	10 200	58,0
60,0	68,1	112,4	12 100	10 900	10 100	12 100	10 900	10 100	60,0
62,0	67,1	111,3	11 800	10 700	9 900	11 800	10 700	9 900	62,0
64,0	66,0	110,2	11 500	10 500	9 800	11 500	10 500	9 800	64,0
66,0	65,0	109,0	11 300	10 400	9 700	11 300	10 400	9 700	66,0
68,0	63,9	107,7	11 000	10 200	9 500	11 000	10 200	9 500	68,0
70,0	62,8	106,5	10 800	10 100	9 400	10 800	10 100	9 400	70,0
72,0	61,7	105,1	10 600	9 900	9 300	10 600	9 900	9 300	72,0
74,0	60,6	103,7	10 400	9 800	9 200	10 400	9 800	9 200	74,0
76,0	59,4	102,3	10 200	9 600	9 100	10 200	9 600	9 100	76,0
78,0	58,3	100,7	10 000	9 500	9 000	10 000	9 500	9 000	78,0
80,0	57,1	99,1	9 800	9 400	8 900	9 800	9 400	8 900	80,0
82,0	55,9	97,5	9 600	9 300	8 700	9 600	9 300	8 700	82,0
84,0	54,7	95,8	9 400	9 100	8 600	9 400	9 100	8 600	84,0
88,0	52,2	92,1	9 100	8 900	8 400	9 100	8 900	8 400	88,0
92,0	49,6	88,1	8 800	8 700	8 300	8 800	8 700	8 300	92,0
96,0	46,8	83,6	8 500	8 500	8 100	8 500	8 500	8 100	96,0
100,0	43,9	78,8	8 200	8 200	7 900	8 200	8 200	7 900	100,0
104,0	40,8	73,3	7 700	7 300	6 900	8 000	8 000	7 800	104,0
108,0	37,5	67,2	6 400	6 100	5 700	7 800	7 800	7 700	108,0
112,0	33,8	60,1	5 200	4 900	4 600	7 600	7 600	7 500	112,0
116,0	29,5	51,7	4 000			7 500			116,0
120,0									120,0

# MLC300 VPC-MAX S-2

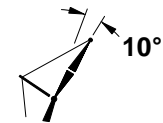
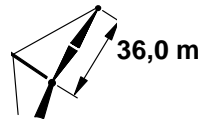
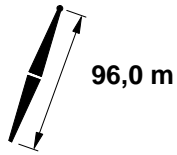

m	°	m	10,6 m			14,6 m			m			
			0°			1°				2°		
			kg	kg	kg	kg	kg	kg		kg	kg	kg
21,3	84,6	132,6	20 900			20 900			21,3			
22,0	84,3	132,5	20 800			20 800			22,0			
24,0	83,4	132,2	20 500	16 800		20 500	16 800		24,0			
26,0	82,6	131,8	20 200	16 700	11 900	20 200	16 700	11 900	26,0			
28,0	81,7	131,4	19 900	16 500	11 900	19 900	16 500	11 900	28,0			
30,0	80,8	131,0	19 600	16 400	11 900	19 600	16 400	11 900	30,0			
32,0	79,9	130,6	19 300	16 200	11 900	19 300	16 200	11 900	32,0			
34,0	79,0	130,1	18 900	16 000	11 900	18 900	16 000	11 900	34,0			
36,0	78,1	129,5	18 600	15 800	11 900	18 600	15 800	11 900	36,0			
38,0	77,2	129,0	18 200	15 500	11 900	18 200	15 500	11 900	38,0			
40,0	76,3	128,4	17 900	15 300	11 900	17 900	15 300	11 900	40,0			
42,0	75,4	127,8	17 600	15 100	11 900	17 600	15 100	11 900	42,0			
44,0	74,5	127,1	17 200	14 900	11 900	17 200	14 900	11 900	44,0			
46,0	73,5	126,4	16 900	14 700	11 900	16 900	14 700	11 900	46,0			
48,0	72,6	125,7	16 600	14 500	11 900	16 600	14 500	11 900	48,0			
50,0	71,7	124,9	16 300	14 300	11 800	16 300	14 300	11 800	50,0			
52,0	70,7	124,1	16 000	14 100	11 700	16 000	14 100	11 700	52,0			
54,0	69,8	123,2	15 700	13 800	11 500	15 700	13 800	11 500	54,0			
56,0	68,9	122,4	15 400	13 600	11 400	15 400	13 600	11 400	56,0			
58,0	67,9	121,4	15 100	13 400	11 200	15 100	13 400	11 200	58,0			
60,0	66,9	120,5	14 800	13 200	11 100	14 800	13 200	11 100	60,0			
62,0	66,0	119,5	14 500	13 000	10 900	14 500	13 000	10 900	62,0			
64,0	65,0	118,4	14 200	12 800	10 800	14 200	12 800	10 800	64,0			
66,0	64,0	117,3	14 000	12 600	10 600	14 000	12 600	10 600	66,0			
68,0	63,0	116,2	13 700	12 400	10 500	13 700	12 400	10 500	68,0			
70,0	62,0	115,0	13 500	12 200	10 400	13 500	12 200	10 400	70,0			
72,0	61,0	113,7	13 200	12 000	10 200	13 200	12 000	10 200	72,0			
74,0	59,9	112,4	13 000	11 800	10 100	13 000	11 800	10 100	74,0			
76,0	58,9	111,1	12 800	11 600	9 900	12 800	11 600	9 900	76,0			
78,0	57,8	109,7	12 500	11 500	9 800	12 500	11 500	9 800	78,0			
80,0	56,7	108,3	12 300	11 300	9 700	12 300	11 300	9 700	80,0			
82,0	55,7	106,7	12 100	11 100	9 500	12 100	11 100	9 500	82,0			
84,0	54,6	105,2	11 900	10 900	9 400	11 900	10 900	9 400	84,0			
88,0	52,3	101,8	11 500	10 600	9 200	11 500	10 600	9 200	88,0			
92,0	50,0	98,2	10 400	9 700	8 800	11 100	10 300	8 900	92,0			
96,0	47,5	94,3	8 900	8 300	7 700	10 800	10 000	8 700	96,0			
100,0	45,0	90,0	7 500	7 000	6 400	10 500	9 700	8 500	100,0			
104,0	42,3	85,3	6 200	5 700	5 300	10 200	9 500	8 300	104,0			
108,0	39,4	80,1	5 000	4 600	4 200	9 800	9 200	8 100	108,0			
112,0	36,4	74,3	3 900	3 500	3 100	9 500	9 000	7 900	112,0			
116,0	33,1	67,8				9 200	8 800	7 800	116,0			
120,0	29,4	60,3				9 000	8 600	7 600	120,0			
124,0	25,1	51,3				8 600	8 200	7 500	124,0			
128,0	19,8	39,8				7 600	7 300	7 000	128,0			

# MLC300 VPC-MAX S-2



148  
+  
B60

175 100 kg

360°

96,0 m

36,0 m

20°

m	°	m	10,6 m			14,6 m			m
			0°	1°	2°	0°	1°	2°	
			kg	kg	kg	kg	kg	kg	
21,3									21,3
22,0									22,0
24,0									24,0
26,0									26,0
28,0	84,1	130,2	17 200			17 200			28,0
30,0	83,2	129,8	16 900	13 600		16 900	13 600		30,0
32,0	82,3	129,3	16 600	13 400	10 000	16 600	13 400	10 000	32,0
34,0	81,4	128,8	16 300	13 200	10 000	16 300	13 200	10 000	34,0
36,0	80,5	128,3	16 000	13 000	10 000	16 000	13 000	10 000	36,0
38,0	79,6	127,7	15 800	12 800	10 000	15 800	12 800	10 000	38,0
40,0	78,7	127,1	15 500	12 700	10 000	15 500	12 700	10 000	40,0
42,0	77,8	126,5	15 200	12 500	10 000	15 200	12 500	10 000	42,0
44,0	76,8	125,8	15 000	12 300	10 000	15 000	12 300	10 000	44,0
46,0	75,9	125,1	14 700	12 200	10 000	14 700	12 200	10 000	46,0
48,0	75,0	124,4	14 300	12 000	10 000	14 300	12 000	10 000	48,0
50,0	74,0	123,6	14 000	11 800	10 000	14 000	11 800	10 000	50,0
52,0	73,1	122,8	13 600	11 600	10 000	13 600	11 600	10 000	52,0
54,0	72,1	121,9	13 300	11 500	10 000	13 300	11 500	10 000	54,0
56,0	71,2	121,0	13 000	11 300	10 000	13 000	11 300	10 000	56,0
58,0	70,2	120,1	12 700	11 200	10 000	12 700	11 200	10 000	58,0
60,0	69,2	119,1	12 400	11 000	10 000	12 400	11 000	10 000	60,0
62,0	68,2	118,1	12 100	10 800	10 000	12 100	10 800	10 000	62,0
64,0	67,2	117,0	11 900	10 700	9 900	11 900	10 700	9 900	64,0
66,0	66,2	115,9	11 600	10 500	9 800	11 600	10 500	9 800	66,0
68,0	65,2	114,7	11 400	10 400	9 600	11 400	10 400	9 600	68,0
70,0	64,2	113,5	11 100	10 200	9 500	11 100	10 200	9 500	70,0
72,0	63,2	112,3	10 900	10 100	9 400	10 900	10 100	9 400	72,0
74,0	62,1	111,0	10 700	10 000	9 300	10 700	10 000	9 300	74,0
76,0	61,1	109,6	10 500	9 800	9 200	10 500	9 800	9 200	76,0
78,0	60,0	108,2	10 300	9 700	9 100	10 300	9 700	9 100	78,0
80,0	58,9	106,7	10 100	9 600	9 000	10 100	9 600	9 000	80,0
82,0	57,8	105,2	9 900	9 500	8 900	9 900	9 500	8 900	82,0
84,0	56,7	103,6	9 700	9 300	8 800	9 700	9 300	8 800	84,0
88,0	54,4	100,2	9 400	9 100	8 600	9 400	9 100	8 600	88,0
92,0	52,0	96,5	9 100	8 900	8 400	9 100	8 900	8 400	92,0
96,0	49,5	92,5	8 800	8 600	8 100	8 800	8 700	8 200	96,0
100,0	46,9	88,1	8 200	7 600	7 100	8 500	8 500	8 100	100,0
104,0	44,2	83,3	6 800	6 300	5 800	8 300	8 200	7 900	104,0
108,0	41,3	78,0	5 500	5 100	4 700	8 000	8 000	7 800	108,0
112,0	38,1	72,1	4 300	3 900	3 600	7 900	7 800	7 700	112,0
116,0	34,7	65,3				7 700	7 600	7 600	116,0
120,0	30,8	57,4				7 500	7 500	7 400	120,0
124,0									124,0
128,0									128,0



# MLC300 VPC-MAX S-2

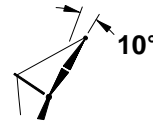
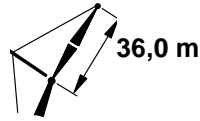
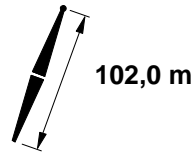

m	°	m	10,6 m		14,6 m		m
			0°		1°		
			kg	kg	kg	kg	
21,3	84,8	138,7	20 400		20 400		21,3
22,0	84,6	138,6	20 400		20 400		22,0
24,0	83,7	138,2	20 100		20 100		24,0
26,0	82,9	137,9	19 800	14 100	19 800	14 100	26,0
28,0	82,0	137,5	19 600	14 100	19 600	14 100	28,0
30,0	81,2	137,1	19 300	14 100	19 300	14 100	30,0
32,0	80,3	136,7	19 000	14 100	19 000	14 100	32,0
34,0	79,5	136,2	18 700	14 100	18 700	14 100	34,0
36,0	78,6	135,7	18 400	14 100	18 400	14 100	36,0
38,0	77,8	135,2	18 100	14 100	18 100	14 100	38,0
40,0	76,9	134,6	17 800	14 100	17 800	14 100	40,0
42,0	76,0	134,0	17 500	14 100	17 500	14 100	42,0
44,0	75,2	133,4	17 200	14 100	17 200	14 100	44,0
46,0	74,3	132,7	16 900	14 100	16 900	14 100	46,0
48,0	73,4	132,0	16 600	14 100	16 600	14 100	48,0
50,0	72,5	131,3	16 300	14 100	16 300	14 100	50,0
52,0	71,6	130,5	16 000	14 000	16 000	14 000	52,0
54,0	70,7	129,7	15 700	13 800	15 700	13 800	54,0
56,0	69,8	128,9	15 500	13 600	15 500	13 600	56,0
58,0	68,9	128,0	15 200	13 400	15 200	13 400	58,0
60,0	68,0	127,1	14 900	13 200	14 900	13 200	60,0
62,0	67,1	126,1	14 700	13 000	14 700	13 000	62,0
64,0	66,2	125,1	14 400	12 800	14 400	12 800	64,0
66,0	65,2	124,1	14 200	12 700	14 200	12 700	66,0
68,0	64,3	123,0	13 900	12 500	13 900	12 500	68,0
70,0	63,3	121,9	13 700	12 300	13 700	12 300	70,0
72,0	62,4	120,7	13 400	12 000	13 400	12 000	72,0
74,0	61,4	119,5	13 200	11 700	13 200	11 700	74,0
76,0	60,4	118,3	13 000	11 400	13 000	11 400	76,0
78,0	59,4	116,9	12 800	11 200	12 800	11 200	78,0
80,0	58,4	115,6	12 500	10 900	12 500	10 900	80,0
82,0	57,4	114,2	12 300	10 600	12 300	10 600	82,0
84,0	56,4	112,7	12 000	10 400	12 000	10 400	84,0
88,0	54,3	109,6	11 400	10 000	11 500	10 000	88,0
92,0	52,1	106,3	9 900	9 100	11 000	9 500	92,0
96,0	49,9	102,6	8 400	7 700	10 600	9 100	96,0
100,0	47,5	98,7	7 000	6 400	10 200	8 800	100,0
104,0	45,1	94,5	5 700	5 200	9 800	8 500	104,0
108,0	42,6	89,8	4 500	4 000	9 500	8 200	108,0
112,0	39,9	84,7	3 400		9 200	7 900	112,0
116,0	37,0	79,1			9 000	7 700	116,0
120,0	33,9	72,8			8 700	7 500	120,0
124,0	30,5	65,6			8 300	7 400	124,0
128,0	26,6	57,2			7 300	7 000	128,0
132,0	22,0	46,9			6 400	6 100	132,0



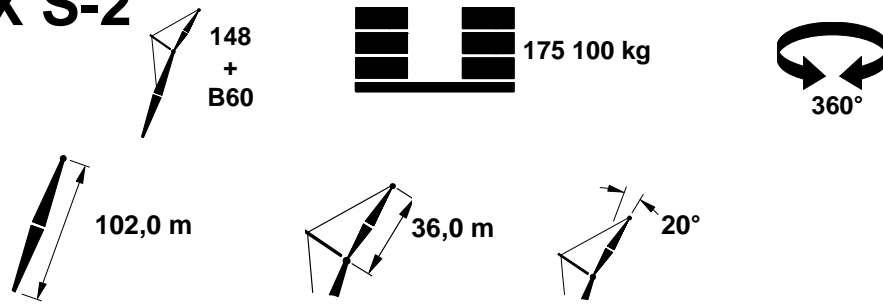



# MLC300 VPC-MAX S-2

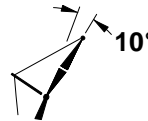
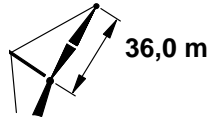

m	°	m	10,6 m		14,6 m		m
			0°	1°	0°	1°	
			kg	kg	kg	kg	
21,3							21,3
22,0							22,0
24,0							24,0
26,0							26,0
28,0	84,4	136,3	17 000		17 000		28,0
30,0	83,5	135,8	16 800	12 300	16 800	12 300	30,0
32,0	82,7	135,4	16 500	12 300	16 500	12 300	32,0
34,0	81,8	134,9	16 200	12 300	16 200	12 300	34,0
36,0	80,9	134,4	16 000	12 300	16 000	12 300	36,0
38,0	80,1	133,9	15 700	12 300	15 700	12 300	38,0
40,0	79,2	133,3	15 500	12 300	15 500	12 300	40,0
42,0	78,3	132,7	15 200	12 300	15 200	12 300	42,0
44,0	77,4	132,1	15 000	12 200	15 000	12 200	44,0
46,0	76,6	131,4	14 700	12 100	14 700	12 100	46,0
48,0	75,7	130,7	14 400	11 900	14 400	11 900	48,0
50,0	74,8	130,0	14 100	11 800	14 100	11 800	50,0
52,0	73,9	129,2	13 800	11 600	13 800	11 600	52,0
54,0	73,0	128,4	13 500	11 500	13 500	11 500	54,0
56,0	72,1	127,5	13 100	11 300	13 100	11 300	56,0
58,0	71,1	126,6	12 900	11 200	12 900	11 200	58,0
60,0	70,2	125,7	12 600	11 000	12 600	11 000	60,0
62,0	69,3	124,7	12 300	10 900	12 300	10 900	62,0
64,0	68,3	123,7	12 000	10 800	12 000	10 800	64,0
66,0	67,4	122,7	11 800	10 600	11 800	10 600	66,0
68,0	66,4	121,6	11 600	10 500	11 600	10 500	68,0
70,0	65,5	120,5	11 300	10 300	11 300	10 300	70,0
72,0	64,5	119,3	11 100	10 200	11 100	10 200	72,0
74,0	63,5	118,0	10 900	10 100	10 900	10 100	74,0
76,0	62,5	116,8	10 700	9 900	10 700	9 900	76,0
78,0	61,5	115,4	10 500	9 800	10 500	9 800	78,0
80,0	60,5	114,1	10 300	9 700	10 300	9 700	80,0
82,0	59,5	112,6	10 100	9 600	10 100	9 600	82,0
84,0	58,4	111,2	9 900	9 400	9 900	9 400	84,0
88,0	56,3	108,0	9 600	9 200	9 600	9 200	88,0
92,0	54,1	104,6	9 300	8 900	9 300	8 900	92,0
96,0	51,8	100,9	9 000	8 300	9 000	8 500	96,0
100,0	49,4	96,9	7 700	7 100	8 700	8 300	100,0
104,0	47,0	92,6	6 400	5 800	8 500	8 000	104,0
108,0	44,4	87,9	5 100	4 600	8 300	7 700	108,0
112,0	41,6	82,6	3 900	3 500	8 100	7 500	112,0
116,0	38,7	76,8			7 900	7 300	116,0
120,0	35,4	70,3			7 700	7 200	120,0
124,0	31,9	62,8			7 600	7 100	124,0
128,0	27,8	54,0			7 400	7 100	128,0
132,0							132,0

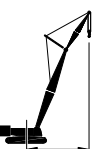
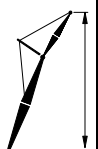
# MLC300 VPC-MAX S-2



			 10,6 m		 14,6 m	
 m			 0°		 m	
			 kg		 kg	
22,9	84,5	144,5	19 900	19 900	22,9	
24,0	84,0	144,3	19 800	19 800	24,0	
26,0	83,2	144,0	19 600	19 600	26,0	
28,0	82,4	143,6	19 300	19 300	28,0	
30,0	81,6	143,2	19 100	19 100	30,0	
32,0	80,7	142,8	18 800	18 800	32,0	
34,0	79,9	142,4	18 500	18 500	34,0	
36,0	79,1	141,9	18 300	18 300	36,0	
38,0	78,3	141,4	18 000	18 000	38,0	
40,0	77,5	140,8	17 700	17 700	40,0	
42,0	76,6	140,3	17 400	17 400	42,0	
44,0	75,8	139,7	17 200	17 200	44,0	
46,0	75,0	139,0	16 900	16 900	46,0	
48,0	74,1	138,4	16 600	16 600	48,0	
50,0	73,3	137,7	16 300	16 300	50,0	
52,0	72,4	136,9	16 100	16 100	52,0	
54,0	71,6	136,2	15 800	15 800	54,0	
56,0	70,7	135,4	15 600	15 600	56,0	
58,0	69,9	134,5	15 300	15 300	58,0	
60,0	69,0	133,7	15 000	15 000	60,0	
62,0	68,1	132,8	14 800	14 800	62,0	
64,0	67,2	131,8	14 600	14 600	64,0	
66,0	66,4	130,8	14 300	14 300	66,0	
68,0	65,5	129,8	14 100	14 100	68,0	
70,0	64,6	128,8	13 900	13 900	70,0	
72,0	63,6	127,6	13 500	13 500	72,0	
74,0	62,7	126,5	13 200	13 200	74,0	
76,0	61,8	125,3	12 800	12 800	76,0	
78,0	60,9	124,1	12 500	12 500	78,0	
80,0	59,9	122,8	12 200	12 200	80,0	
82,0	59,0	121,5	11 800	11 800	82,0	
84,0	58,0	120,1	11 500	11 500	84,0	
88,0	56,0	117,2	10 500	11 000	88,0	
92,0	54,0	114,1	8 900	10 500	92,0	
96,0	51,9	110,7	7 400	10 000	96,0	
100,0	49,8	107,1	6 000	9 600	100,0	
104,0	47,6	103,2	4 700	9 200	104,0	
108,0	45,2	99,0	3 500	8 900	108,0	
112,0	42,8	94,4		8 600	112,0	
116,0	40,3	89,4		8 300	116,0	
120,0	37,6	83,9		8 100	120,0	
124,0	34,6	77,7		7 600	124,0	
128,0	31,5	70,8		6 600	128,0	
132,0	27,9	62,9		5 800	132,0	
136,0	23,8	53,4		4 900	136,0	
140,0	18,8	41,3		4 100	140,0	



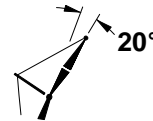
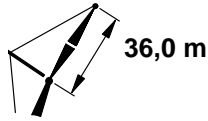
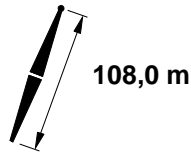





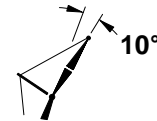
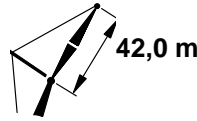
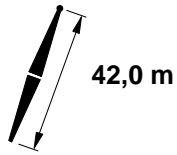
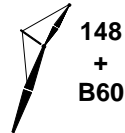

# MLC300 VPC-MAX S-2

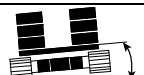
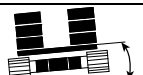

m	°	m	10,6 m		m	
			14,6 m			
			0°	0°		
			kg	kg		
22,9					22,9	
24,0					24,0	
26,0					26,0	
28,0	84,6	142,3	16 900	16 900	28,0	
30,0	83,8	142,0	16 600	16 600	30,0	
32,0	83,0	141,5	16 400	16 400	32,0	
34,0	82,2	141,1	16 200	16 200	34,0	
36,0	81,3	140,6	15 900	15 900	36,0	
38,0	80,5	140,1	15 700	15 700	38,0	
40,0	79,7	139,5	15 500	15 500	40,0	
42,0	78,8	139,0	15 200	15 200	42,0	
44,0	78,0	138,4	15 000	15 000	44,0	
46,0	77,1	137,7	14 800	14 800	46,0	
48,0	76,3	137,0	14 600	14 600	48,0	
50,0	75,4	136,3	14 300	14 300	50,0	
52,0	74,6	135,6	14 000	14 000	52,0	
54,0	73,7	134,8	13 700	13 700	54,0	
56,0	72,9	134,0	13 400	13 400	56,0	
58,0	72,0	133,2	13 100	13 100	58,0	
60,0	71,1	132,3	12 800	12 800	60,0	
62,0	70,2	131,4	12 500	12 500	62,0	
64,0	69,3	130,4	12 300	12 300	64,0	
66,0	68,4	129,4	12 000	12 000	66,0	
68,0	67,5	128,4	11 800	11 800	68,0	
70,0	66,6	127,3	11 600	11 600	70,0	
72,0	65,7	126,2	11 300	11 300	72,0	
74,0	64,8	125,0	11 100	11 100	74,0	
76,0	63,8	123,8	10 900	10 900	76,0	
78,0	62,9	122,6	10 700	10 700	78,0	
80,0	61,9	121,3	10 500	10 500	80,0	
82,0	61,0	120,0	10 400	10 400	82,0	
84,0	60,0	118,6	10 200	10 200	84,0	
88,0	58,0	115,6	9 800	9 800	88,0	
92,0	55,9	112,5	9 500	9 500	92,0	
96,0	53,8	109,1	8 300	9 200	96,0	
100,0	51,7	105,4	6 800	9 000	100,0	
104,0	49,4	101,4	5 500	8 700	104,0	
108,0	47,0	97,1	4 200	8 400	108,0	
112,0	44,6	92,4		8 100	112,0	
116,0	41,9	87,3		7 900	116,0	
120,0	39,2	81,6		7 800	120,0	
124,0	36,2	75,3		7 600	124,0	
128,0	32,9	68,1		6 900	128,0	
132,0	29,1	59,8		6 000	132,0	
136,0					136,0	
140,0					140,0	

# MLC300 VPC-MAX S-2

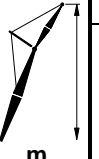

			 10,6 m			 14,6 m			
			 0°    1°    2°			 0°    1°    2°			
			 kg			 kg			 kg
 m			 °			 m			 m
19,8	82,2	84,4	18 300	15 600c		18 300	15 600c		19,8
20,0	82,1	84,3	18 300	15 500c		18 300	15 500c		20,0
22,0	80,7	83,9	17 500	15 000b		17 500	15 000b		22,0
24,0	79,3	83,3	16 800	14 500	12 700b	16 800	14 500	12 700b	24,0
26,0	77,9	82,7	16 100	14 000	12 300	16 100	14 000	12 300	26,0
28,0	76,4	82,1	15 400	13 500	11 900	15 400	13 500	11 900	28,0
30,0	75,0	81,4	14 800	13 000	11 500	14 800	13 000	11 500	30,0
32,0	73,5	80,7	14 100	12 500	11 200	14 100	12 500	11 200	32,0
34,0	72,1	79,9	13 500	12 100	10 800	13 500	12 100	10 800	34,0
36,0	70,6	79,0	13 000	11 600	10 500	13 000	11 600	10 500	36,0
38,0	69,1	78,1	12 400	11 200	10 100	12 400	11 200	10 100	38,0
40,0	67,6	77,1	11 900	10 800	9 800	11 900	10 800	9 800	40,0
42,0	66,0	76,0	11 400	10 400	9 400	11 400	10 400	9 400	42,0
44,0	64,5	74,9	11 000	10 000	9 100	11 000	10 000	9 100	44,0
46,0	62,9	73,7	10 500	9 600	8 800	10 500	9 600	8 800	46,0
48,0	61,3	72,4	10 100	9 300	8 500	10 100	9 300	8 500	48,0
50,0	59,6	71,0	9 700	8 900	8 200	9 700	8 900	8 200	50,0
52,0	57,9	69,6	9 300	8 600	8 000	9 300	8 600	8 000	52,0
54,0	56,2	68,0	9 000	8 300	7 700	9 000	8 300	7 700	54,0
56,0	54,5	66,4	8 600	8 000	7 400	8 600	8 000	7 400	56,0
58,0	52,6	64,6	8 300	7 700	7 200	8 300	7 700	7 200	58,0
60,0	50,8	62,8	8 000	7 400	6 900	8 000	7 400	6 900	60,0
62,0	48,9	60,8	7 700	7 200	6 700	7 700	7 200	6 700	62,0
64,0	46,9	58,6	7 400	6 900	6 500	7 400	6 900	6 500	64,0
66,0	44,8	56,3	7 100	6 700	6 300	7 100	6 700	6 300	66,0
68,0	42,6	53,9	6 900	6 500	6 100	6 900	6 500	6 100	68,0
70,0	40,4	51,2	6 700	6 200	5 900	6 700	6 200	5 900	70,0
72,0	37,9	48,3	6 400	6 000	5 700	6 400	6 000	5 700	72,0
74,0	35,4	45,0	6 200	5 900	5 500	6 200	5 900	5 500	74,0
76,0	32,6	41,5	6 000	5 700	5 400	6 000	5 700	5 400	76,0
78,0	29,5	37,4	5 800	5 500	5 200	5 800	5 500	5 200	78,0
80,0	26,0	32,7	5 700	5 400	5 100	5 700	5 400	5 100	80,0
82,0	21,9	27,0	5 500	5 300	5 000	5 500	5 300	5 000	82,0

# MLC300 VPC-MAX S-2



148  
+  
B60

175 100 kg

360°

42,0 m

42,0 m

20°

m	°	m	10,6 m			14,6 m			m			
			0°			1°				2°		
			kg	kg	kg	kg	kg	kg		kg	kg	kg
19,8											19,8	
20,0											20,0	
22,0											22,0	
24,0											24,0	
26,0	82,4	81,9	13 900	11 400b		13 900	11 400b				26,0	
28,0	81,0	81,2	13 300	11 000		13 300	11 000				28,0	
30,0	79,5	80,5	12 800	10 600	9 600	12 800	10 600	9 600			30,0	
32,0	78,1	79,8	12 300	10 200	9 300	12 300	10 200	9 300			32,0	
34,0	76,6	79,0	11 800	9 900	9 100	11 800	9 900	9 100			34,0	
36,0	75,1	78,1	11 300	9 500	8 800	11 300	9 500	8 800			36,0	
38,0	73,6	77,1	10 900	9 200	8 500	10 900	9 200	8 500			38,0	
40,0	72,0	76,1	10 500	8 900	8 200	10 500	8 900	8 200			40,0	
42,0	70,5	75,1	10 100	8 600	8 000	10 100	8 600	8 000			42,0	
44,0	68,9	73,9	9 700	8 300	7 700	9 700	8 300	7 700			44,0	
46,0	67,3	72,7	9 300	8 000	7 500	9 300	8 000	7 500			46,0	
48,0	65,6	71,4	9 000	7 800	7 200	9 000	7 800	7 200			48,0	
50,0	64,0	70,0	8 700	7 500	7 000	8 700	7 500	7 000			50,0	
52,0	62,2	68,5	8 400	7 200	6 800	8 400	7 200	6 800			52,0	
54,0	60,5	67,0	8 100	7 000	6 600	8 100	7 000	6 600			54,0	
56,0	58,7	65,3	7 800	6 800	6 400	7 800	6 800	6 400			56,0	
58,0	56,9	63,5	7 500	6 600	6 200	7 500	6 600	6 200			58,0	
60,0	55,0	61,6	7 300	6 400	6 000	7 300	6 400	6 000			60,0	
62,0	53,0	59,6	7 000	6 200	5 800	7 000	6 200	5 800			62,0	
64,0	51,0	57,4	6 800	6 000	5 700	6 800	6 000	5 700			64,0	
66,0	48,9	55,0	6 600	5 800	5 500	6 600	5 800	5 500			66,0	
68,0	46,6	52,5	6 400	5 700	5 400	6 400	5 700	5 400			68,0	
70,0	44,3	49,7	6 200	5 500	5 200	6 200	5 500	5 200			70,0	
72,0	41,8	46,7	6 000	5 400	5 100	6 000	5 400	5 100			72,0	
74,0	39,1	43,4	5 900	5 200	5 000	5 900	5 200	5 000			74,0	
76,0	36,2	39,6	5 800	5 100	4 900	5 800	5 100	4 900			76,0	
78,0	33,0	35,4	5 600	5 000	4 800	5 600	5 000	4 800			78,0	
80,0	29,2	30,3	5 500			5 500					80,0	
82,0											82,0	

# MLC300 VPC-MAX S-2

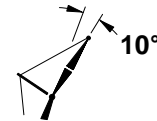
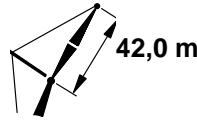
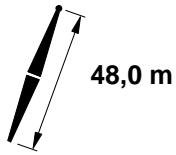

m	°	m	10,6 m			14,6 m			m			
			0°			1°				2°		
			kg	kg	kg	kg	kg	kg		kg	kg	kg
16,8	84,7	91,1	19 500 <sup>b</sup>			19 500 <sup>b</sup>			16,8			
18,0	83,9	90,9	19 100			19 100			18,0			
20,0	82,6	90,5	18 400	15 600 <sup>b</sup>	13 400 <sup>c</sup>	18 400	15 600 <sup>b</sup>	13 400 <sup>c</sup>	20,0			
22,0	81,3	90,0	17 800	15 100	13 100 <sup>c</sup>	17 800	15 100	13 100 <sup>c</sup>	22,0			
24,0	80,0	89,5	17 100	14 600	12 800	17 100	14 600	12 800	24,0			
26,0	78,7	89,0	16 400	14 200	12 400	16 400	14 200	12 400	26,0			
28,0	77,4	88,4	15 800	13 700	12 100	15 800	13 700	12 100	28,0			
30,0	76,0	87,8	15 200	13 300	11 700	15 200	13 300	11 700	30,0			
32,0	74,7	87,1	14 600	12 800	11 400	14 600	12 800	11 400	32,0			
34,0	73,3	86,3	14 000	12 400	11 000	14 000	12 400	11 000	34,0			
36,0	72,0	85,5	13 500	12 000	10 700	13 500	12 000	10 700	36,0			
38,0	70,6	84,7	12 900	11 600	10 400	12 900	11 600	10 400	38,0			
40,0	69,2	83,8	12 400	11 200	10 100	12 400	11 200	10 100	40,0			
42,0	67,8	82,8	12 000	10 800	9 800	12 000	10 800	9 800	42,0			
44,0	66,4	81,7	11 500	10 400	9 500	11 500	10 400	9 500	44,0			
46,0	64,9	80,6	11 100	10 100	9 200	11 100	10 100	9 200	46,0			
48,0	63,4	79,5	10 600	9 700	8 900	10 600	9 700	8 900	48,0			
50,0	61,9	78,2	10 200	9 400	8 600	10 200	9 400	8 600	50,0			
52,0	60,4	76,9	9 900	9 100	8 300	9 900	9 100	8 300	52,0			
54,0	58,9	75,5	9 500	8 800	8 100	9 500	8 800	8 100	54,0			
56,0	57,3	74,1	9 200	8 500	7 800	9 200	8 500	7 800	56,0			
58,0	55,7	72,5	8 800	8 200	7 600	8 800	8 200	7 600	58,0			
60,0	54,0	70,8	8 500	7 900	7 400	8 500	7 900	7 400	60,0			
62,0	52,3	69,1	8 200	7 700	7 100	8 200	7 700	7 100	62,0			
64,0	50,6	67,2	7 900	7 400	6 900	7 900	7 400	6 900	64,0			
66,0	48,8	65,2	7 700	7 200	6 700	7 700	7 200	6 700	66,0			
68,0	47,0	63,1	7 400	6 900	6 500	7 400	6 900	6 500	68,0			
70,0	45,1	60,9	7 200	6 700	6 300	7 200	6 700	6 300	70,0			
72,0	43,1	58,5	6 900	6 500	6 100	6 900	6 500	6 100	72,0			
74,0	41,0	55,9	6 700	6 300	5 900	6 700	6 300	5 900	74,0			
76,0	38,8	53,0	6 500	6 100	5 800	6 500	6 100	5 800	76,0			
78,0	36,5	50,0	6 300	5 900	5 600	6 300	5 900	5 600	78,0			
80,0	34,0	46,6	6 100	5 800	5 400	6 100	5 800	5 400	80,0			
82,0	31,3	42,9	5 900	5 600	5 300	5 900	5 600	5 300	82,0			
84,0	28,3	38,7	5 800	5 500	5 200	5 800	5 500	5 200	84,0			
88,0	21,0	27,8	5 500	5 200	4 900	5 500	5 200	4 900	88,0			

# MLC300 VPC-MAX S-2

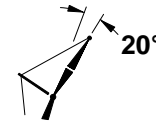
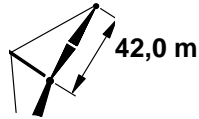
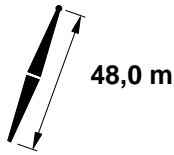
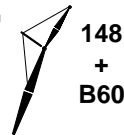

m	°	m	10,6 m			14,6 m			m			
			0°			1°				2°		
			kg	kg	kg	kg	kg	kg		kg	kg	kg
16,8										16,8		
18,0										18,0		
20,0										20,0		
22,0										22,0		
24,0										24,0		
26,0	83,0	88,1	14 100	11 500		14 100	11 500			26,0		
28,0	81,6	87,5	13 500	11 100	10 000	13 500	11 100	10 000		28,0		
30,0	80,3	86,8	13 000	10 800	9 800	13 000	10 800	9 800		30,0		
32,0	78,9	86,1	12 500	10 400	9 500	12 500	10 400	9 500		32,0		
34,0	77,5	85,4	12 100	10 100	9 200	12 100	10 100	9 200		34,0		
36,0	76,2	84,5	11 600	9 800	9 000	11 600	9 800	9 000		36,0		
38,0	74,8	83,7	11 200	9 400	8 700	11 200	9 400	8 700		38,0		
40,0	73,4	82,8	10 800	9 100	8 400	10 800	9 100	8 400		40,0		
42,0	71,9	81,8	10 400	8 800	8 200	10 400	8 800	8 200		42,0		
44,0	70,5	80,7	10 100	8 600	7 900	10 100	8 600	7 900		44,0		
46,0	69,0	79,6	9 700	8 300	7 700	9 700	8 300	7 700		46,0		
48,0	67,5	78,4	9 400	8 000	7 500	9 400	8 000	7 500		48,0		
50,0	66,0	77,2	9 100	7 800	7 300	9 100	7 800	7 300		50,0		
52,0	64,5	75,8	8 800	7 600	7 100	8 800	7 600	7 100		52,0		
54,0	62,9	74,4	8 500	7 300	6 900	8 500	7 300	6 900		54,0		
56,0	61,3	72,9	8 200	7 100	6 700	8 200	7 100	6 700		56,0		
58,0	59,6	71,3	7 900	6 900	6 500	7 900	6 900	6 500		58,0		
60,0	58,0	69,7	7 700	6 700	6 300	7 700	6 700	6 300		60,0		
62,0	56,2	67,9	7 400	6 500	6 100	7 400	6 500	6 100		62,0		
64,0	54,5	66,0	7 200	6 300	6 000	7 200	6 300	6 000		64,0		
66,0	52,6	64,0	7 000	6 100	5 800	7 000	6 100	5 800		66,0		
68,0	50,8	61,8	6 800	6 000	5 700	6 800	6 000	5 700		68,0		
70,0	48,8	59,5	6 600	5 800	5 500	6 600	5 800	5 500		70,0		
72,0	46,8	57,0	6 400	5 700	5 400	6 400	5 700	5 400		72,0		
74,0	44,6	54,3	6 300	5 500	5 200	6 300	5 500	5 200		74,0		
76,0	42,4	51,4	6 100	5 400	5 100	6 100	5 400	5 100		76,0		
78,0	40,0	48,3	5 900	5 300	5 000	5 900	5 300	5 000		78,0		
80,0	37,4	44,8	5 800	5 200	4 900	5 800	5 200	4 900		80,0		
82,0	34,6	40,9	5 700	5 100	4 800	5 700	5 100	4 800		82,0		
84,0	31,4	36,4	5 600	5 000	4 700	5 600	5 000	4 700		84,0		
88,0										88,0		



# MLC300 VPC-MAX S-2

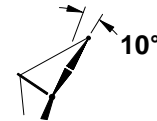
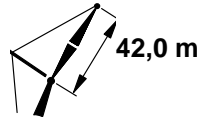
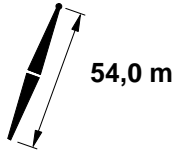

m	°	m	10,6 m			14,6 m			m			
			0°			1°				2°		
			kg	kg	kg	kg	kg	kg		kg	kg	kg
18,3	84,1	96,9	19 100			19 100			18,3			
20,0	83,1	96,6	18 500	15 600b		18 500	15 600b		20,0			
22,0	81,9	96,2	17 900	15 200	13 100b	17 900	15 200	13 100b	22,0			
24,0	80,7	95,7	17 300	14 700	12 900	17 300	14 700	12 900	24,0			
26,0	79,4	95,2	16 700	14 300	12 500	16 700	14 300	12 500	26,0			
28,0	78,2	94,6	16 100	13 900	12 200	16 100	13 900	12 200	28,0			
30,0	76,9	94,0	15 500	13 500	11 900	15 500	13 500	11 900	30,0			
32,0	75,7	93,4	14 900	13 100	11 600	14 900	13 100	11 600	32,0			
34,0	74,4	92,7	14 400	12 700	11 300	14 400	12 700	11 300	34,0			
36,0	73,2	92,0	13 900	12 300	10 900	13 900	12 300	10 900	36,0			
38,0	71,9	91,2	13 300	11 900	10 700	13 300	11 900	10 700	38,0			
40,0	70,6	90,3	12 900	11 500	10 300	12 900	11 500	10 300	40,0			
42,0	69,3	89,4	12 400	11 200	10 100	12 400	11 200	10 100	42,0			
44,0	68,0	88,5	12 000	10 800	9 800	12 000	10 800	9 800	44,0			
46,0	66,6	87,5	11 500	10 500	9 500	11 500	10 500	9 500	46,0			
48,0	65,3	86,4	11 100	10 100	9 200	11 100	10 100	9 200	48,0			
50,0	63,9	85,2	10 700	9 800	8 900	10 700	9 800	8 900	50,0			
52,0	62,5	84,0	10 400	9 500	8 700	10 400	9 500	8 700	52,0			
54,0	61,1	82,8	10 000	9 200	8 400	10 000	9 200	8 400	54,0			
56,0	59,7	81,4	9 700	8 900	8 200	9 700	8 900	8 200	56,0			
58,0	58,2	80,0	9 300	8 600	7 900	9 300	8 600	7 900	58,0			
60,0	56,7	78,5	9 100	8 300	7 700	9 100	8 300	7 700	60,0			
62,0	55,2	77,0	8 700	8 100	7 500	8 700	8 100	7 500	62,0			
64,0	53,7	75,3	8 500	7 800	7 300	8 500	7 800	7 300	64,0			
66,0	52,1	73,5	8 200	7 600	7 100	8 200	7 600	7 100	66,0			
68,0	50,4	71,7	7 900	7 400	6 900	7 900	7 400	6 900	68,0			
70,0	48,8	69,7	7 600	7 100	6 700	7 600	7 100	6 700	70,0			
72,0	47,1	67,6	7 400	6 900	6 500	7 400	6 900	6 500	72,0			
74,0	45,3	65,4	7 200	6 700	6 300	7 200	6 700	6 300	74,0			
76,0	43,4	63,0	7 000	6 500	6 100	7 000	6 500	6 100	76,0			
78,0	41,5	60,5	6 800	6 300	6 000	6 800	6 300	6 000	78,0			
80,0	39,5	57,8	6 600	6 200	5 800	6 600	6 200	5 800	80,0			
82,0	37,4	54,8	6 400	6 000	5 600	6 400	6 000	5 600	82,0			
84,0	35,1	51,7	6 200	5 800	5 500	6 200	5 800	5 500	84,0			
88,0	30,1	44,3	5 900	5 600	5 200	5 900	5 600	5 200	88,0			
92,0	24,0	34,8	5 600	5 300	5 000	5 600	5 300	5 000	92,0			

# MLC300 VPC-MAX S-2

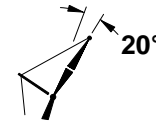
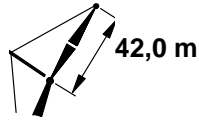
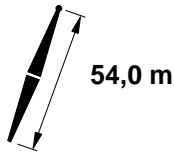
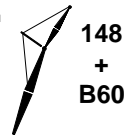

m	°	m	10,6 m			14,6 m			m			
			0°			1°				2°		
			kg	kg	kg	kg	kg	kg		kg	kg	kg
18,3										18,3		
20,0										20,0		
22,0										22,0		
24,0										24,0		
26,0	83,4	94,2	14 200	11 600		14 200	11 600			26,0		
28,0	82,2	93,7	13 700	11 200	10 100	13 700	11 200	10 100		28,0		
30,0	80,9	93,1	13 200	10 900	9 900	13 200	10 900	9 900		30,0		
32,0	79,7	92,4	12 800	10 600	9 600	12 800	10 600	9 600		32,0		
34,0	78,4	91,7	12 300	10 300	9 300	12 300	10 300	9 300		34,0		
36,0	77,1	91,0	11 900	9 900	9 100	11 900	9 900	9 100		36,0		
38,0	75,8	90,1	11 500	9 600	8 900	11 500	9 600	8 900		38,0		
40,0	74,5	89,3	11 100	9 400	8 600	11 100	9 400	8 600		40,0		
42,0	73,2	88,4	10 700	9 100	8 400	10 700	9 100	8 400		42,0		
44,0	71,8	87,4	10 400	8 800	8 100	10 400	8 800	8 100		44,0		
46,0	70,5	86,4	10 100	8 600	7 900	10 100	8 600	7 900		46,0		
48,0	69,1	85,3	9 700	8 300	7 700	9 700	8 300	7 700		48,0		
50,0	67,7	84,1	9 400	8 100	7 500	9 400	8 100	7 500		50,0		
52,0	66,3	82,9	9 100	7 900	7 300	9 100	7 900	7 300		52,0		
54,0	64,9	81,6	8 800	7 600	7 100	8 800	7 600	7 100		54,0		
56,0	63,4	80,3	8 600	7 400	6 900	8 600	7 400	6 900		56,0		
58,0	61,9	78,9	8 300	7 200	6 700	8 300	7 200	6 700		58,0		
60,0	60,4	77,3	8 000	7 000	6 600	8 000	7 000	6 600		60,0		
62,0	58,9	75,7	7 800	6 800	6 400	7 800	6 800	6 400		62,0		
64,0	57,3	74,1	7 600	6 600	6 200	7 600	6 600	6 200		64,0		
66,0	55,7	72,3	7 300	6 500	6 100	7 300	6 500	6 100		66,0		
68,0	54,0	70,4	7 200	6 300	5 900	7 200	6 300	5 900		68,0		
70,0	52,3	68,4	7 000	6 100	5 800	7 000	6 100	5 800		70,0		
72,0	50,6	66,2	6 800	6 000	5 600	6 800	6 000	5 600		72,0		
74,0	48,8	64,0	6 600	5 800	5 500	6 600	5 800	5 500		74,0		
76,0	46,9	61,5	6 400	5 700	5 400	6 400	5 700	5 400		76,0		
78,0	44,9	58,9	6 300	5 500	5 300	6 300	5 500	5 300		78,0		
80,0	42,8	56,1	6 100	5 400	5 100	6 100	5 400	5 100		80,0		
82,0	40,6	53,1	6 000	5 300	5 000	6 000	5 300	5 000		82,0		
84,0	38,3	49,8	5 900	5 200	4 900	5 900	5 200	4 900		84,0		
88,0	33,1	42,1	5 600	5 000	4 800	5 600	5 000	4 800		88,0		
92,0										92,0		

# MLC300 VPC-MAX S-2

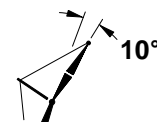
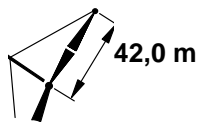
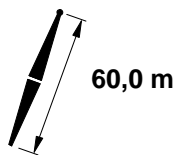

m	°	m	10,6 m			14,6 m			m			
			0°			1°				2°		
			kg	kg	kg	kg	kg	kg		kg	kg	kg
18,3	84,5	102,9	19 100			19 100			18,3			
20,0	83,5	102,7	18 600	15 700		18 600	15 700		20,0			
22,0	82,4	102,3	18 000	15 300	13 100 <sup>b</sup>	18 000	15 300	13 100 <sup>b</sup>	22,0			
24,0	81,2	101,8	17 500	14 800	12 900	17 500	14 800	12 900	24,0			
26,0	80,1	101,4	16 900	14 400	12 600	16 900	14 400	12 600	26,0			
28,0	78,9	100,9	16 300	14 000	12 300	16 300	14 000	12 300	28,0			
30,0	77,7	100,3	15 800	13 700	12 000	15 800	13 700	12 000	30,0			
32,0	76,6	99,7	15 200	13 300	11 700	15 200	13 300	11 700	32,0			
34,0	75,4	99,0	14 700	12 900	11 400	14 700	12 900	11 400	34,0			
36,0	74,2	98,4	14 200	12 500	11 100	14 200	12 500	11 100	36,0			
38,0	73,0	97,6	13 800	12 200	10 800	13 800	12 200	10 800	38,0			
40,0	71,8	96,8	13 300	11 800	10 600	13 300	11 800	10 600	40,0			
42,0	70,6	96,0	12 800	11 500	10 300	12 800	11 500	10 300	42,0			
44,0	69,4	95,1	12 400	11 100	10 000	12 400	11 100	10 000	44,0			
46,0	68,1	94,2	12 000	10 800	9 800	12 000	10 800	9 800	46,0			
48,0	66,9	93,2	11 600	10 500	9 500	11 600	10 500	9 500	48,0			
50,0	65,6	92,1	11 200	10 200	9 200	11 200	10 200	9 200	50,0			
52,0	64,3	91,0	10 800	9 900	9 000	10 800	9 900	9 000	52,0			
54,0	63,0	89,8	10 500	9 600	8 700	10 500	9 600	8 700	54,0			
56,0	61,7	88,6	10 100	9 300	8 500	10 100	9 300	8 500	56,0			
58,0	60,4	87,3	9 800	9 000	8 300	9 800	9 000	8 300	58,0			
60,0	59,0	86,0	9 500	8 700	8 000	9 500	8 700	8 000	60,0			
62,0	57,6	84,5	9 200	8 500	7 800	9 200	8 500	7 800	62,0			
64,0	56,2	83,0	8 900	8 200	7 600	8 900	8 200	7 600	64,0			
66,0	54,8	81,4	8 700	8 000	7 400	8 700	8 000	7 400	66,0			
68,0	53,3	79,8	8 400	7 800	7 200	8 400	7 800	7 200	68,0			
70,0	51,8	78,0	8 100	7 600	7 000	8 100	7 600	7 000	70,0			
72,0	50,3	76,1	7 900	7 300	6 800	7 900	7 300	6 800	72,0			
74,0	48,7	74,2	7 600	7 100	6 600	7 600	7 100	6 600	74,0			
76,0	47,1	72,1	7 400	6 900	6 500	7 400	6 900	6 500	76,0			
78,0	45,5	69,9	7 200	6 800	6 300	7 200	6 800	6 300	78,0			
80,0	43,7	67,6	7 000	6 600	6 100	7 000	6 600	6 100	80,0			
82,0	42,0	65,1	6 800	6 400	6 000	6 800	6 400	6 000	82,0			
84,0	40,1	62,5	6 600	6 200	5 800	6 600	6 200	5 800	84,0			
88,0	36,1	56,6	6 300	5 900	5 500	6 300	5 900	5 500	88,0			
92,0	31,6	49,6	6 000	5 600	5 300	6 000	5 600	5 300	92,0			
96,0	26,3	41,1	5 700	5 400	5 100	5 700	5 400	5 100	96,0			
100,0	19,4	29,4	5 500	5 200	4 900	5 500	5 200	4 900	100,0			

# MLC300 VPC-MAX S-2

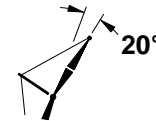
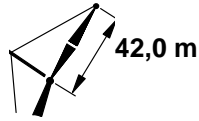
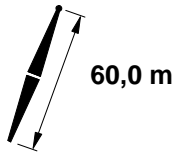
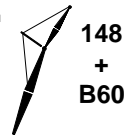

m	°	m	10,6 m			14,6 m			m
			0°	1°	2°	0°	1°	2°	
			kg	kg	kg	kg	kg	kg	
18,3									18,3
20,0									20,0
22,0									22,0
24,0									24,0
26,0	83,8	100,4	14 300	11 600		14 300	11 600		26,0
28,0	82,7	99,8	13 800	11 300	10 200	13 800	11 300	10 200	28,0
30,0	81,5	99,3	13 400	11 000	9 900	13 400	11 000	9 900	30,0
32,0	80,3	98,7	13 000	10 700	9 700	13 000	10 700	9 700	32,0
34,0	79,1	98,0	12 500	10 400	9 400	12 500	10 400	9 400	34,0
36,0	77,9	97,3	12 100	10 100	9 200	12 100	10 100	9 200	36,0
38,0	76,7	96,6	11 800	9 800	9 000	11 800	9 800	9 000	38,0
40,0	75,5	95,8	11 400	9 500	8 800	11 400	9 500	8 800	40,0
42,0	74,2	94,9	11 000	9 300	8 500	11 000	9 300	8 500	42,0
44,0	73,0	94,0	10 700	9 000	8 300	10 700	9 000	8 300	44,0
46,0	71,7	93,1	10 400	8 800	8 100	10 400	8 800	8 100	46,0
48,0	70,5	92,0	10 000	8 600	7 900	10 000	8 600	7 900	48,0
50,0	69,2	91,0	9 700	8 300	7 700	9 700	8 300	7 700	50,0
52,0	67,9	89,9	9 500	8 100	7 500	9 500	8 100	7 500	52,0
54,0	66,6	88,7	9 200	7 900	7 300	9 200	7 900	7 300	54,0
56,0	65,2	87,4	8 900	7 700	7 200	8 900	7 700	7 200	56,0
58,0	63,9	86,1	8 700	7 500	7 000	8 700	7 500	7 000	58,0
60,0	62,5	84,7	8 400	7 300	6 800	8 400	7 300	6 800	60,0
62,0	61,1	83,3	8 100	7 100	6 600	8 100	7 100	6 600	62,0
64,0	59,7	81,8	7 900	6 900	6 500	7 900	6 900	6 500	64,0
66,0	58,2	80,2	7 700	6 700	6 300	7 700	6 700	6 300	66,0
68,0	56,8	78,5	7 500	6 600	6 200	7 500	6 600	6 200	68,0
70,0	55,2	76,7	7 300	6 400	6 000	7 300	6 400	6 000	70,0
72,0	53,7	74,8	7 100	6 200	5 900	7 100	6 200	5 900	72,0
74,0	52,1	72,8	6 900	6 100	5 800	6 900	6 100	5 800	74,0
76,0	50,4	70,7	6 700	5 900	5 600	6 700	5 900	5 600	76,0
78,0	48,7	68,4	6 600	5 800	5 500	6 600	5 800	5 500	78,0
80,0	47,0	66,0	6 400	5 700	5 400	6 400	5 700	5 400	80,0
82,0	45,1	63,5	6 300	5 600	5 200	6 300	5 600	5 200	82,0
84,0	43,2	60,8	6 100	5 400	5 100	6 100	5 400	5 100	84,0
88,0	39,1	54,7	5 900	5 200	5 000	5 900	5 200	5 000	88,0
92,0	34,4	47,5	5 700	5 000	4 800	5 700	5 000	4 800	92,0
96,0	28,8	38,4	5 500	4 900	4 700	5 500	4 900	4 700	96,0
100,0									100,0

# MLC300 VPC-MAX S-2

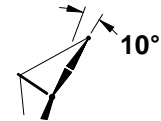
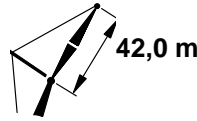
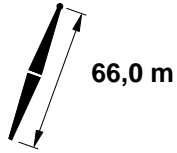
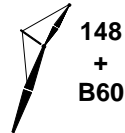

m	°	m	10,6 m			14,6 m			m			
			0°			1°				2°		
			kg	kg	kg	kg	kg	kg		kg	kg	kg
18,3	84,8	109,0	19 100			19 100				18,3		
20,0	83,9	108,7	18 600	15 600		18 600	15 600			20,0		
22,0	82,8	108,4	18 100	15 300		18 100	15 300			22,0		
24,0	81,7	107,9	17 600	14 900	12 800	17 600	14 900	12 800		24,0		
26,0	80,6	107,5	17 000	14 500	12 600	17 000	14 500	12 600		26,0		
28,0	79,5	107,0	16 500	14 100	12 300	16 500	14 100	12 300		28,0		
30,0	78,4	106,5	16 000	13 800	12 100	16 000	13 800	12 100		30,0		
32,0	77,3	105,9	15 500	13 400	11 800	15 500	13 400	11 800		32,0		
34,0	76,2	105,3	15 000	13 100	11 500	15 000	13 100	11 500		34,0		
36,0	75,1	104,7	14 500	12 700	11 200	14 500	12 700	11 200		36,0		
38,0	74,0	104,0	14 100	12 400	11 000	14 100	12 400	11 000		38,0		
40,0	72,9	103,2	13 600	12 100	10 700	13 600	12 100	10 700		40,0		
42,0	71,7	102,4	13 200	11 700	10 500	13 200	11 700	10 500		42,0		
44,0	70,6	101,6	12 800	11 400	10 200	12 800	11 400	10 200		44,0		
46,0	69,4	100,7	12 400	11 100	10 000	12 400	11 100	10 000		46,0		
48,0	68,3	99,8	12 000	10 800	9 700	12 000	10 800	9 700		48,0		
50,0	67,1	98,8	11 600	10 500	9 500	11 600	10 500	9 500		50,0		
52,0	65,9	97,8	11 300	10 200	9 200	11 300	10 200	9 200		52,0		
54,0	64,7	96,7	10 900	9 900	9 000	10 900	9 900	9 000		54,0		
56,0	63,5	95,6	10 600	9 600	8 800	10 600	9 600	8 800		56,0		
58,0	62,2	94,4	10 300	9 400	8 600	10 300	9 400	8 600		58,0		
60,0	61,0	93,1	9 900	9 100	8 300	9 900	9 100	8 300		60,0		
62,0	59,7	91,8	9 700	8 900	8 100	9 700	8 900	8 100		62,0		
64,0	58,4	90,4	9 400	8 600	7 900	9 400	8 600	7 900		64,0		
66,0	57,1	89,0	9 100	8 400	7 700	9 100	8 400	7 700		66,0		
68,0	55,8	87,5	8 800	8 200	7 500	8 800	8 200	7 500		68,0		
70,0	54,4	85,9	8 600	7 900	7 300	8 600	7 900	7 300		70,0		
72,0	53,0	84,2	8 300	7 700	7 100	8 300	7 700	7 100		72,0		
74,0	51,6	82,4	8 100	7 500	7 000	8 100	7 500	7 000		74,0		
76,0	50,2	80,6	7 900	7 300	6 800	7 900	7 300	6 800		76,0		
78,0	48,7	78,6	7 600	7 100	6 600	7 600	7 100	6 600		78,0		
80,0	47,2	76,6	7 400	6 900	6 400	7 400	6 900	6 400		80,0		
82,0	45,6	74,4	7 200	6 700	6 300	7 200	6 700	6 300		82,0		
84,0	44,0	72,1	7 000	6 600	6 100	7 000	6 600	6 100		84,0		
88,0	40,6	67,1	6 700	6 300	5 800	6 700	6 300	5 800		88,0		
92,0	36,9	61,4	6 300	6 000	5 600	6 300	6 000	5 600		92,0		
96,0	32,8	54,8	6 000	5 700	5 400	6 000	5 700	5 400		96,0		
100,0	28,1	46,8	5 800	5 400	5 100	5 800	5 400	5 100		100,0		
104,0	22,3	36,7	5 500	5 300	5 000	5 500	5 300	5 000		104,0		

# MLC300 VPC-MAX S-2



148  
+  
B60

175 100 kg

360°

66,0 m

42,0 m

20°

m	°	m	10,6 m			14,6 m			m			
			0°			1°				2°		
			kg	kg	kg	kg	kg	kg		kg	kg	kg
18,3										18,3		
20,0										20,0		
22,0										22,0		
24,0										24,0		
26,0	84,2	106,4	14 400			14 400				26,0		
28,0	83,1	106,0	13 900	11 300		13 900	11 300			28,0		
30,0	82,0	105,4	13 500	11 100	10 000	13 500	11 100	10 000		30,0		
32,0	80,9	104,8	13 100	10 800	9 800	13 100	10 800	9 800		32,0		
34,0	79,7	104,2	12 700	10 500	9 500	12 700	10 500	9 500		34,0		
36,0	78,6	103,6	12 300	10 200	9 300	12 300	10 200	9 300		36,0		
38,0	77,5	102,9	12 000	10 000	9 100	12 000	10 000	9 100		38,0		
40,0	76,3	102,1	11 600	9 700	8 900	11 600	9 700	8 900		40,0		
42,0	75,2	101,3	11 300	9 500	8 700	11 300	9 500	8 700		42,0		
44,0	74,0	100,5	10 900	9 200	8 500	10 900	9 200	8 500		44,0		
46,0	72,9	99,6	10 600	9 000	8 300	10 600	9 000	8 300		46,0		
48,0	71,7	98,7	10 300	8 700	8 100	10 300	8 700	8 100		48,0		
50,0	70,5	97,7	10 000	8 500	7 900	10 000	8 500	7 900		50,0		
52,0	69,3	96,6	9 700	8 300	7 700	9 700	8 300	7 700		52,0		
54,0	68,1	95,5	9 500	8 100	7 500	9 500	8 100	7 500		54,0		
56,0	66,8	94,4	9 200	7 900	7 300	9 200	7 900	7 300		56,0		
58,0	65,6	93,2	9 000	7 700	7 200	9 000	7 700	7 200		58,0		
60,0	64,3	91,9	8 700	7 500	7 000	8 700	7 500	7 000		60,0		
62,0	63,0	90,6	8 500	7 300	6 900	8 500	7 300	6 900		62,0		
64,0	61,7	89,2	8 200	7 100	6 700	8 200	7 100	6 700		64,0		
66,0	60,4	87,7	8 000	7 000	6 500	8 000	7 000	6 500		66,0		
68,0	59,0	86,1	7 800	6 800	6 400	7 800	6 800	6 400		68,0		
70,0	57,6	84,5	7 600	6 700	6 300	7 600	6 700	6 300		70,0		
72,0	56,2	82,8	7 400	6 500	6 100	7 400	6 500	6 100		72,0		
74,0	54,8	81,0	7 200	6 400	6 000	7 200	6 400	6 000		74,0		
76,0	53,3	79,1	7 100	6 200	5 800	7 100	6 200	5 800		76,0		
78,0	51,8	77,2	6 900	6 100	5 700	6 900	6 100	5 700		78,0		
80,0	50,3	75,1	6 700	5 900	5 600	6 700	5 900	5 600		80,0		
82,0	48,7	72,8	6 600	5 800	5 500	6 600	5 800	5 500		82,0		
84,0	47,0	70,5	6 500	5 700	5 400	6 500	5 700	5 400		84,0		
88,0	43,5	65,4	6 200	5 500	5 200	6 200	5 500	5 200		88,0		
92,0	39,7	59,5	5 900	5 300	5 000	5 900	5 300	5 000		92,0		
96,0	35,5	52,6	5 700	5 100	4 800	5 700	5 100	4 800		96,0		
100,0	30,5	44,3	5 600	5 000	4 700	5 600	5 000	4 700		100,0		
104,0										104,0		

# MLC300 VPC-MAX S-2

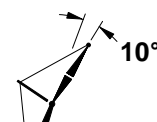
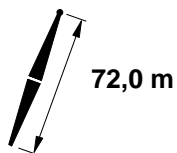
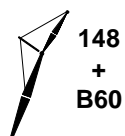

m	°	m	10,6 m			14,6 m			m			
			0°			1°				2°		
			kg	kg	kg	kg	kg	kg		kg	kg	kg
19,8	84,3	114,8	18 600			18 600				19,8		
20,0	84,2	114,8	18 600			18 600				20,0		
22,0	83,2	114,4	18 100	15 200		18 100	15 200			22,0		
24,0	82,2	114,1	17 600	14 900	12 700	17 600	14 900	12 700		24,0		
26,0	81,1	113,6	17 100	14 500	12 500	17 100	14 500	12 500		26,0		
28,0	80,1	113,2	16 700	14 200	12 300	16 700	14 200	12 300		28,0		
30,0	79,1	112,7	16 200	13 800	12 100	16 200	13 800	12 100		30,0		
32,0	78,0	112,2	15 700	13 500	11 800	15 700	13 500	11 800		32,0		
34,0	77,0	111,6	15 200	13 200	11 600	15 200	13 200	11 600		34,0		
36,0	75,9	111,0	14 800	12 900	11 300	14 800	12 900	11 300		36,0		
38,0	74,9	110,3	14 400	12 600	11 100	14 400	12 600	11 100		38,0		
40,0	73,8	109,6	13 900	12 300	10 800	13 900	12 300	10 800		40,0		
42,0	72,7	108,9	13 500	11 900	10 600	13 500	11 900	10 600		42,0		
44,0	71,7	108,1	13 100	11 600	10 400	13 100	11 600	10 400		44,0		
46,0	70,6	107,3	12 700	11 300	10 100	12 700	11 300	10 100		46,0		
48,0	69,5	106,4	12 300	11 000	9 900	12 300	11 000	9 900		48,0		
50,0	68,4	105,5	12 000	10 800	9 700	12 000	10 800	9 700		50,0		
52,0	67,3	104,5	11 600	10 500	9 500	11 600	10 500	9 500		52,0		
54,0	66,1	103,5	11 300	10 200	9 200	11 300	10 200	9 200		54,0		
56,0	65,0	102,5	11 000	9 900	9 000	11 000	9 900	9 000		56,0		
58,0	63,9	101,3	10 600	9 700	8 800	10 600	9 700	8 800		58,0		
60,0	62,7	100,2	10 300	9 400	8 600	10 300	9 400	8 600		60,0		
62,0	61,5	99,0	10 100	9 200	8 400	10 100	9 200	8 400		62,0		
64,0	60,3	97,7	9 800	8 900	8 200	9 800	8 900	8 200		64,0		
66,0	59,1	96,3	9 500	8 700	8 000	9 500	8 700	8 000		66,0		
68,0	57,9	94,9	9 200	8 500	7 800	9 200	8 500	7 800		68,0		
70,0	56,6	93,5	9 000	8 300	7 600	9 000	8 300	7 600		70,0		
72,0	55,4	91,9	8 700	8 100	7 400	8 700	8 100	7 400		72,0		
74,0	54,1	90,3	8 500	7 900	7 200	8 500	7 900	7 200		74,0		
76,0	52,8	88,6	8 200	7 700	7 100	8 200	7 700	7 100		76,0		
78,0	51,4	86,9	8 100	7 500	6 900	8 100	7 500	6 900		78,0		
80,0	50,1	85,0	7 800	7 300	6 800	7 800	7 300	6 800		80,0		
82,0	48,7	83,1	7 600	7 100	6 600	7 600	7 100	6 600		82,0		
84,0	47,2	81,1	7 400	6 900	6 400	7 400	6 900	6 400		84,0		
88,0	44,2	76,6	7 100	6 600	6 100	7 100	6 600	6 100		88,0		
92,0	41,1	71,7	6 700	6 300	5 900	6 700	6 300	5 900		92,0		
96,0	37,6	66,2	6 400	6 000	5 600	6 400	6 000	5 600		96,0		
100,0	33,9	59,9	6 100	5 700	5 400	6 100	5 700	5 400		100,0		
104,0	29,6	52,4	5 800	5 500	5 200	5 800	5 500	5 200		104,0		
108,0	24,6	43,2	5 600	5 300	5 000	5 600	5 300	5 000		108,0		
112,0	18,0	30,8	5 400	5 200	4 900	5 400	5 200	4 900		112,0		

# MLC300 VPC-MAX S-2



148  
+  
B60

175 100 kg

360°

72,0 m

42,0 m

20°

m	°	m	10,6 m			14,6 m			m
			0°	1°	2°	0°	1°	2°	
			kg	kg	kg	kg	kg	kg	
19,8									19,8
20,0									20,0
22,0									22,0
24,0									24,0
26,0	84,5	112,6	14 400			14 400			26,0
28,0	83,5	112,1	14 000	11 400		14 000	11 400		28,0
30,0	82,4	111,6	13 600	11 100	10 000	13 600	11 100	10 000	30,0
32,0	81,4	111,1	13 200	10 800	9 800	13 200	10 800	9 800	32,0
34,0	80,3	110,5	12 900	10 600	9 600	12 900	10 600	9 600	34,0
36,0	79,2	109,9	12 500	10 300	9 400	12 500	10 300	9 400	36,0
38,0	78,2	109,2	12 200	10 100	9 200	12 200	10 100	9 200	38,0
40,0	77,1	108,5	11 800	9 800	9 000	11 800	9 800	9 000	40,0
42,0	76,0	107,7	11 500	9 600	8 800	11 500	9 600	8 800	42,0
44,0	74,9	107,0	11 200	9 400	8 600	11 200	9 400	8 600	44,0
46,0	73,8	106,1	10 900	9 200	8 400	10 900	9 200	8 400	46,0
48,0	72,7	105,2	10 600	8 900	8 200	10 600	8 900	8 200	48,0
50,0	71,6	104,3	10 300	8 700	8 000	10 300	8 700	8 000	50,0
52,0	70,5	103,3	10 000	8 500	7 900	10 000	8 500	7 900	52,0
54,0	69,3	102,3	9 700	8 300	7 700	9 700	8 300	7 700	54,0
56,0	68,2	101,2	9 500	8 100	7 500	9 500	8 100	7 500	56,0
58,0	67,0	100,1	9 200	7 900	7 300	9 200	7 900	7 300	58,0
60,0	65,8	98,9	9 000	7 700	7 200	9 000	7 700	7 200	60,0
62,0	64,7	97,7	8 800	7 500	7 000	8 800	7 500	7 000	62,0
64,0	63,4	96,4	8 500	7 400	6 900	8 500	7 400	6 900	64,0
66,0	62,2	95,0	8 300	7 200	6 700	8 300	7 200	6 700	66,0
68,0	61,0	93,6	8 100	7 100	6 600	8 100	7 100	6 600	68,0
70,0	59,7	92,1	7 900	6 900	6 400	7 900	6 900	6 400	70,0
72,0	58,4	90,6	7 700	6 700	6 300	7 700	6 700	6 300	72,0
74,0	57,1	88,9	7 500	6 600	6 200	7 500	6 600	6 200	74,0
76,0	55,8	87,2	7 400	6 500	6 100	7 400	6 500	6 100	76,0
78,0	54,4	85,4	7 200	6 300	5 900	7 200	6 300	5 900	78,0
80,0	53,0	83,6	7 000	6 200	5 800	7 000	6 200	5 800	80,0
82,0	51,6	81,6	6 900	6 100	5 700	6 900	6 100	5 700	82,0
84,0	50,2	79,5	6 700	5 900	5 600	6 700	5 900	5 600	84,0
88,0	47,1	75,0	6 500	5 700	5 400	6 500	5 700	5 400	88,0
92,0	43,8	70,0	6 200	5 500	5 200	6 200	5 500	5 200	92,0
96,0	40,3	64,3	6 000	5 300	5 000	6 000	5 300	5 000	96,0
100,0	36,4	57,7	5 800	5 100	4 900	5 800	5 100	4 900	100,0
104,0	32,0	49,9	5 600	5 000	4 800	5 600	5 000	4 800	104,0
108,0	26,6	40,2	5 500			5 500			108,0
112,0									112,0



# MLC300 VPC-MAX S-2

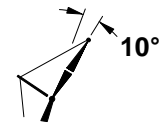
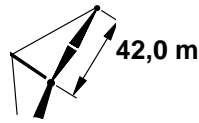
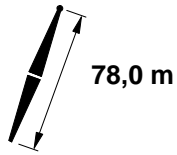

m	°	m	10,6 m			14,6 m			m			
			0°			1°				2°		
			kg	kg	kg	kg	kg	kg		kg	kg	kg
19,8	84,6	120,9	18 300			18 300				19,8		
20,0	84,5	120,9	18 300			18 300				20,0		
22,0	83,5	120,5	17 900	14 500		17 900	14 500			22,0		
24,0	82,6	120,2	17 500	14 200		17 500	14 200			24,0		
26,0	81,6	119,8	17 100	13 900	12 100	17 100	13 900	12 100		26,0		
28,0	80,6	119,3	16 700	13 600	11 800	16 700	13 600	11 800		28,0		
30,0	79,6	118,9	16 200	13 300	11 600	16 200	13 300	11 600		30,0		
32,0	78,6	118,4	15 800	12 900	11 400	15 800	12 900	11 400		32,0		
34,0	77,7	117,8	15 400	12 600	11 100	15 400	12 600	11 100		34,0		
36,0	76,7	117,2	15 000	12 300	10 900	15 000	12 300	10 900		36,0		
38,0	75,7	116,6	14 500	12 100	10 700	14 500	12 100	10 700		38,0		
40,0	74,7	116,0	14 100	11 700	10 400	14 100	11 700	10 400		40,0		
42,0	73,6	115,3	13 800	11 500	10 200	13 800	11 500	10 200		42,0		
44,0	72,6	114,5	13 400	11 200	10 000	13 400	11 200	10 000		44,0		
46,0	71,6	113,8	13 000	10 900	9 800	13 000	10 900	9 800		46,0		
48,0	70,6	112,9	12 600	10 600	9 600	12 600	10 600	9 600		48,0		
50,0	69,5	112,1	12 300	10 400	9 400	12 300	10 400	9 400		50,0		
52,0	68,5	111,2	11 900	10 100	9 200	11 900	10 100	9 200		52,0		
54,0	67,4	110,2	11 600	9 900	8 900	11 600	9 900	8 900		54,0		
56,0	66,4	109,2	11 300	9 600	8 700	11 300	9 600	8 700		56,0		
58,0	65,3	108,2	11 000	9 400	8 600	11 000	9 400	8 600		58,0		
60,0	64,2	107,1	10 700	9 100	8 300	10 700	9 100	8 300		60,0		
62,0	63,1	106,0	10 400	8 900	8 200	10 400	8 900	8 200		62,0		
64,0	62,0	104,8	10 100	8 700	8 000	10 100	8 700	8 000		64,0		
66,0	60,9	103,5	9 800	8 500	7 800	9 800	8 500	7 800		66,0		
68,0	59,7	102,2	9 600	8 300	7 600	9 600	8 300	7 600		68,0		
70,0	58,6	100,9	9 300	8 100	7 400	9 300	8 100	7 400		70,0		
72,0	57,4	99,4	9 100	7 900	7 300	9 100	7 900	7 300		72,0		
74,0	56,2	98,0	8 900	7 700	7 100	8 900	7 700	7 100		74,0		
76,0	55,0	96,4	8 600	7 500	7 000	8 600	7 500	7 000		76,0		
78,0	53,8	94,8	8 400	7 400	6 800	8 400	7 400	6 800		78,0		
80,0	52,5	93,1	8 200	7 200	6 700	8 200	7 200	6 700		80,0		
82,0	51,3	91,3	8 000	7 000	6 500	8 000	7 000	6 500		82,0		
84,0	50,0	89,5	7 800	6 800	6 400	7 800	6 800	6 400		84,0		
88,0	47,3	85,5	7 400	6 500	6 100	7 400	6 500	6 100		88,0		
92,0	44,5	81,2	7 000	6 200	5 800	7 000	6 200	5 800		92,0		
96,0	41,5	76,4	6 700	6 000	5 600	6 700	6 000	5 600		96,0		
100,0	38,3	71,0	6 400	5 700	5 400	6 400	5 700	5 400		100,0		
104,0	34,8	64,8	6 100	5 500	5 200	6 100	5 500	5 200		104,0		
108,0	30,9	57,8	5 900	5 300	5 000	5 900	5 300	5 000		108,0		
112,0	26,5	49,3	5 700	5 100	4 800	5 700	5 100	4 800		112,0		
116,0	21,0	38,6	5 500	4 900	4 700	5 500	4 900	4 700		116,0		

# MLC300 VPC-MAX S-2



148  
+  
B60

175 100 kg

360°

78,0 m

42,0 m

20°

m	°	m	10,6 m			14,6 m			m
			0°	1°	2°	0°	1°	2°	
			kg	kg	kg	kg	kg	kg	
19,8								19,8	
20,0								20,0	
22,0								22,0	
24,0								24,0	
26,0	84,8	118,7	14 400			14 400		26,0	
28,0	83,8	118,2	14 000			14 000		28,0	
30,0	82,8	117,7	13 700	11 100		13 700	11 100	30,0	
32,0	81,8	117,2	13 300	10 900	9 700	13 300	10 900	9 700	32,0
34,0	80,8	116,7	13 000	10 600	9 600	13 000	10 600	9 600	34,0
36,0	79,8	116,1	12 600	10 400	9 400	12 600	10 400	9 400	36,0
38,0	78,8	115,5	12 300	10 100	9 200	12 300	10 100	9 200	38,0
40,0	77,8	114,8	12 000	9 900	9 000	12 000	9 900	9 000	40,0
42,0	76,8	114,1	11 700	9 700	8 800	11 700	9 700	8 800	42,0
44,0	75,7	113,4	11 300	9 500	8 700	11 300	9 500	8 700	44,0
46,0	74,7	112,6	11 000	9 300	8 500	11 000	9 300	8 500	46,0
48,0	73,7	111,7	10 800	9 000	8 300	10 800	9 000	8 300	48,0
50,0	72,6	110,9	10 500	8 800	8 100	10 500	8 800	8 100	50,0
52,0	71,5	110,0	10 200	8 600	8 000	10 200	8 600	8 000	52,0
54,0	70,5	109,0	10 000	8 400	7 800	10 000	8 400	7 800	54,0
56,0	69,4	108,0	9 700	8 300	7 600	9 700	8 300	7 600	56,0
58,0	68,3	106,9	9 500	8 100	7 500	9 500	8 100	7 500	58,0
60,0	67,2	105,8	9 200	7 900	7 300	9 200	7 900	7 300	60,0
62,0	66,1	104,7	9 000	7 700	7 200	9 000	7 700	7 200	62,0
64,0	65,0	103,5	8 800	7 600	7 100	8 800	7 600	7 100	64,0
66,0	63,8	102,2	8 600	7 400	6 900	8 600	7 400	6 900	66,0
68,0	62,7	100,9	8 400	7 200	6 800	8 400	7 200	6 800	68,0
70,0	61,5	99,5	8 200	7 100	6 600	8 200	7 100	6 600	70,0
72,0	60,3	98,1	8 000	6 900	6 500	8 000	6 900	6 500	72,0
74,0	59,1	96,6	7 800	6 800	6 400	7 800	6 800	6 400	74,0
76,0	57,9	95,0	7 700	6 600	6 200	7 700	6 600	6 200	76,0
78,0	56,7	93,4	7 500	6 500	6 100	7 500	6 500	6 100	78,0
80,0	55,4	91,7	7 300	6 400	6 000	7 300	6 400	6 000	80,0
82,0	54,1	89,9	7 200	6 200	5 900	7 200	6 200	5 900	82,0
84,0	52,8	88,0	7 000	6 100	5 800	7 000	6 100	5 800	84,0
88,0	50,0	84,0	6 700	5 900	5 600	6 700	5 900	5 600	88,0
92,0	47,2	79,5	6 400	5 700	5 400	6 400	5 700	5 400	92,0
96,0	44,1	74,6	6 200	5 500	5 200	6 200	5 500	5 200	96,0
100,0	40,8	69,0	6 000	5 300	5 000	6 000	5 300	5 000	100,0
104,0	37,2	62,7	5 800	5 100	4 900	5 800	5 100	4 900	104,0
108,0	33,2	55,4	5 600	5 000	4 800	5 600	5 000	4 800	108,0
112,0	28,5	46,5	5 500	4 900	4 700	5 500	4 900	4 700	112,0
116,0									116,0

# MLC300 VPC-MAX S-2

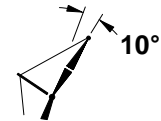
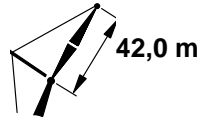
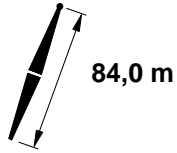

m	°	m	10,6 m			14,6 m			m			
			0°			1°				2°		
			kg	kg	kg	kg	kg	kg		kg	kg	kg
19,8	84,8	126,9	18 100			18 100				19,8		
20,0	84,8	126,9	18 000			18 000				20,0		
22,0	83,8	126,6	17 800			17 800				22,0		
24,0	82,9	126,3	17 500	14 100		17 500	14 100			24,0		
26,0	82,0	125,9	17 100	13 800	12 000	17 100	13 800	12 000		26,0		
28,0	81,1	125,5	16 700	13 500	11 700	16 700	13 500	11 700		28,0		
30,0	80,1	125,0	16 300	13 200	11 500	16 300	13 200	11 500		30,0		
32,0	79,2	124,6	15 900	13 000	11 300	15 900	13 000	11 300		32,0		
34,0	78,3	124,0	15 500	12 700	11 100	15 500	12 700	11 100		34,0		
36,0	77,3	123,5	15 100	12 400	10 900	15 100	12 400	10 900		36,0		
38,0	76,4	122,9	14 700	12 100	10 700	14 700	12 100	10 700		38,0		
40,0	75,4	122,3	14 300	11 900	10 500	14 300	11 900	10 500		40,0		
42,0	74,5	121,6	13 900	11 600	10 300	13 900	11 600	10 300		42,0		
44,0	73,5	120,9	13 600	11 300	10 100	13 600	11 300	10 100		44,0		
46,0	72,5	120,2	13 200	11 100	9 900	13 200	11 100	9 900		46,0		
48,0	71,6	119,4	12 900	10 800	9 700	12 900	10 800	9 700		48,0		
50,0	70,6	118,6	12 500	10 500	9 500	12 500	10 500	9 500		50,0		
52,0	69,6	117,7	12 200	10 300	9 300	12 200	10 300	9 300		52,0		
54,0	68,6	116,9	11 900	10 100	9 100	11 900	10 100	9 100		54,0		
56,0	67,6	115,9	11 600	9 800	8 900	11 600	9 800	8 900		56,0		
58,0	66,6	114,9	11 300	9 600	8 700	11 300	9 600	8 700		58,0		
60,0	65,6	113,9	11 000	9 400	8 500	11 000	9 400	8 500		60,0		
62,0	64,5	112,8	10 700	9 200	8 300	10 700	9 200	8 300		62,0		
64,0	63,5	111,7	10 400	8 900	8 100	10 400	8 900	8 100		64,0		
66,0	62,4	110,6	10 200	8 700	8 000	10 200	8 700	8 000		66,0		
68,0	61,4	109,3	9 900	8 500	7 800	9 900	8 500	7 800		68,0		
70,0	60,3	108,1	9 700	8 400	7 600	9 700	8 400	7 600		70,0		
72,0	59,2	106,8	9 400	8 200	7 500	9 400	8 200	7 500		72,0		
74,0	58,1	105,4	9 200	8 000	7 300	9 200	8 000	7 300		74,0		
76,0	57,0	103,9	9 000	7 800	7 200	9 000	7 800	7 200		76,0		
78,0	55,8	102,5	8 700	7 600	7 000	8 700	7 600	7 000		78,0		
80,0	54,7	100,9	8 600	7 500	6 900	8 600	7 500	6 900		80,0		
82,0	53,5	99,3	8 300	7 300	6 700	8 300	7 300	6 700		82,0		
84,0	52,3	97,6	8 100	7 100	6 600	8 100	7 100	6 600		84,0		
88,0	49,9	94,0	7 800	6 800	6 300	7 800	6 800	6 300		88,0		
92,0	47,3	90,0	7 400	6 500	6 100	7 400	6 500	6 100		92,0		
96,0	44,7	85,7	7 100	6 200	5 800	7 100	6 200	5 800		96,0		
100,0	41,8	81,0	6 800	6 000	5 600	6 800	6 000	5 600		100,0		
104,0	38,8	75,7	6 500	5 800	5 400	6 500	5 800	5 400		104,0		
108,0	35,6	69,8	6 200	5 500	5 200	6 200	5 500	5 200		108,0		
112,0	32,0	63,0	5 700	5 300	5 000	6 000	5 300	5 000		112,0		
116,0	28,0	55,1	4 700	4 400	4 200	5 700	5 200	4 900		116,0		
120,0	23,2	45,4	3 700	3 500		5 500	5 000	4 700		120,0		

# MLC300 VPC-MAX S-2



148  
+  
B60

175 100 kg

360°

84,0 m

42,0 m

20°

m	°	m	10,6 m			14,6 m			m
			0°	1°	2°	0°	1°	2°	
			kg	kg	kg	kg	kg	kg	
19,8									19,8
20,0									20,0
22,0									22,0
24,0									24,0
26,0									26,0
28,0	84,1	124,3	14 100			14 100			28,0
30,0	83,2	123,9	13 700	11 100		13 700	11 100		30,0
32,0	82,2	123,4	13 400	10 900	9 700	13 400	10 900	9 700	32,0
34,0	81,3	122,9	13 000	10 600	9 600	13 000	10 600	9 600	34,0
36,0	80,3	122,3	12 700	10 400	9 400	12 700	10 400	9 400	36,0
38,0	79,4	121,7	12 400	10 200	9 200	12 400	10 200	9 200	38,0
40,0	78,4	121,1	12 100	10 000	9 000	12 100	10 000	9 000	40,0
42,0	77,4	120,4	11 800	9 800	8 900	11 800	9 800	8 900	42,0
44,0	76,5	119,7	11 500	9 600	8 700	11 500	9 600	8 700	44,0
46,0	75,5	119,0	11 200	9 400	8 500	11 200	9 400	8 500	46,0
48,0	74,5	118,2	11 000	9 200	8 400	11 000	9 200	8 400	48,0
50,0	73,5	117,4	10 700	9 000	8 200	10 700	9 000	8 200	50,0
52,0	72,5	116,5	10 400	8 800	8 100	10 400	8 800	8 100	52,0
54,0	71,5	115,6	10 200	8 600	7 900	10 200	8 600	7 900	54,0
56,0	70,5	114,7	9 900	8 400	7 800	9 900	8 400	7 800	56,0
58,0	69,5	113,7	9 700	8 200	7 600	9 700	8 200	7 600	58,0
60,0	68,4	112,6	9 500	8 100	7 500	9 500	8 100	7 500	60,0
62,0	67,4	111,6	9 300	7 900	7 300	9 300	7 900	7 300	62,0
64,0	66,3	110,4	9 000	7 700	7 200	9 000	7 700	7 200	64,0
66,0	65,3	109,2	8 800	7 600	7 000	8 800	7 600	7 000	66,0
68,0	64,2	108,0	8 600	7 400	6 900	8 600	7 400	6 900	68,0
70,0	63,1	106,7	8 400	7 300	6 800	8 400	7 300	6 800	70,0
72,0	62,0	105,4	8 200	7 100	6 600	8 200	7 100	6 600	72,0
74,0	60,9	104,0	8 100	7 000	6 500	8 100	7 000	6 500	74,0
76,0	59,8	102,5	7 900	6 900	6 400	7 900	6 900	6 400	76,0
78,0	58,6	101,0	7 700	6 700	6 300	7 700	6 700	6 300	78,0
80,0	57,4	99,5	7 600	6 600	6 200	7 600	6 600	6 200	80,0
82,0	56,2	97,8	7 400	6 500	6 100	7 400	6 500	6 100	82,0
84,0	55,0	96,1	7 300	6 300	5 900	7 300	6 300	5 900	84,0
88,0	52,5	92,4	7 000	6 100	5 700	7 000	6 100	5 700	88,0
92,0	50,0	88,4	6 700	5 900	5 500	6 700	5 900	5 500	92,0
96,0	47,2	84,0	6 400	5 700	5 400	6 400	5 700	5 400	96,0
100,0	44,3	79,1	6 200	5 500	5 200	6 200	5 500	5 200	100,0
104,0	41,3	73,7	6 000	5 300	5 000	6 000	5 300	5 000	104,0
108,0	37,9	67,6	5 800	5 200	4 900	5 800	5 200	4 900	108,0
112,0	34,2	60,6	5 700	5 000	4 800	5 700	5 000	4 800	112,0
116,0	30,0	52,3	5 000	4 800	4 500	5 000	4 700	4 500	116,0
120,0									120,0

# MLC300 VPC-MAX S-2

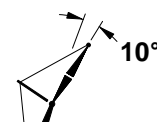
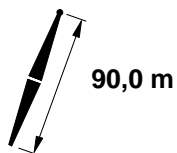

m	°	m	10,6 m			14,6 m			m			
			0°			1°				2°		
			kg	kg	kg	kg	kg	kg		kg	kg	
21,3	84,4	132,8	17 400			17 400			21,3			
22,0	84,1	132,7	17 300			17 300			22,0			
24,0	83,2	132,4	17 100	13 900		17 100	13 900		24,0			
26,0	82,4	132,0	16 800	13 700	10 700	16 800	13 700	10 700	26,0			
28,0	81,5	131,6	16 600	13 400	10 700	16 600	13 400	10 700	28,0			
30,0	80,6	131,2	16 200	13 100	10 700	16 200	13 100	10 700	30,0			
32,0	79,7	130,7	15 900	12 900	10 700	15 900	12 900	10 700	32,0			
34,0	78,8	130,2	15 500	12 600	10 700	15 500	12 600	10 700	34,0			
36,0	77,9	129,7	15 100	12 400	10 700	15 100	12 400	10 700	36,0			
38,0	77,0	129,1	14 800	12 100	10 600	14 800	12 100	10 600	38,0			
40,0	76,1	128,6	14 400	11 900	10 400	14 400	11 900	10 400	40,0			
42,0	75,2	127,9	14 100	11 600	10 200	14 100	11 600	10 200	42,0			
44,0	74,3	127,3	13 700	11 400	10 100	13 700	11 400	10 100	44,0			
46,0	73,4	126,6	13 400	11 100	9 900	13 400	11 100	9 900	46,0			
48,0	72,4	125,8	13 100	10 900	9 700	13 100	10 900	9 700	48,0			
50,0	71,5	125,1	12 700	10 600	9 500	12 700	10 600	9 500	50,0			
52,0	70,6	124,3	12 400	10 400	9 300	12 400	10 400	9 300	52,0			
54,0	69,6	123,4	12 100	10 200	9 200	12 100	10 200	9 200	54,0			
56,0	68,7	122,5	11 800	10 000	9 000	11 800	10 000	9 000	56,0			
58,0	67,7	121,6	11 500	9 700	8 800	11 500	9 700	8 800	58,0			
60,0	66,8	120,6	11 300	9 500	8 600	11 300	9 500	8 600	60,0			
62,0	65,8	119,6	11 000	9 300	8 500	11 000	9 300	8 500	62,0			
64,0	64,8	118,6	10 700	9 100	8 300	10 700	9 100	8 300	64,0			
66,0	63,8	117,5	10 400	8 900	8 100	10 400	8 900	8 100	66,0			
68,0	62,8	116,3	10 200	8 700	8 000	10 200	8 700	8 000	68,0			
70,0	61,8	115,2	9 900	8 500	7 800	9 900	8 500	7 800	70,0			
72,0	60,8	113,9	9 700	8 400	7 600	9 700	8 400	7 600	72,0			
74,0	59,8	112,6	9 500	8 200	7 500	9 500	8 200	7 500	74,0			
76,0	58,7	111,3	9 300	8 000	7 400	9 300	8 000	7 400	76,0			
78,0	57,7	109,9	9 000	7 800	7 200	9 000	7 800	7 200	78,0			
80,0	56,6	108,4	8 900	7 700	7 100	8 900	7 700	7 100	80,0			
82,0	55,5	106,9	8 600	7 500	6 900	8 600	7 500	6 900	82,0			
84,0	54,4	105,4	8 500	7 400	6 800	8 500	7 400	6 800	84,0			
88,0	52,1	102,0	8 000	7 000	6 500	8 000	7 000	6 500	88,0			
92,0	49,8	98,4	7 700	6 700	6 300	7 700	6 700	6 300	92,0			
96,0	47,4	94,5	7 400	6 500	6 000	7 400	6 500	6 000	96,0			
100,0	44,8	90,2	7 100	6 200	5 800	7 100	6 200	5 800	100,0			
104,0	42,2	85,5	6 800	6 000	5 600	6 800	6 000	5 600	104,0			
108,0	39,3	80,4	6 400	5 700	5 300	6 500	5 800	5 400	108,0			
112,0	36,3	74,6	5 300	4 900	4 600	6 200	5 600	5 200	112,0			
116,0	33,0	68,1	4 300	3 900	3 600	6 000	5 400	5 000	116,0			
120,0	29,3	60,6	3 300			5 800	5 200	4 900	120,0			
124,0	25,0	51,7				5 600	5 000	4 800	124,0			
128,0	19,8	40,3				5 500	4 900	4 700	128,0			

# MLC300 VPC-MAX S-2



148  
+  
B60

175 100 kg

360°

90,0 m

42,0 m

20°

m	°	m	10,6 m			14,6 m			m
			0°	1°	2°	0°	1°	2°	
			kg	kg	kg	kg	kg	kg	
21,3								21,3	
22,0								22,0	
24,0								24,0	
26,0								26,0	
28,0	84,4	130,4	14 000			14 000		28,0	
30,0	83,5	130,0	13 700	11 000		13 700	11 000	30,0	
32,0	82,6	129,5	13 400	10 800	9 100	13 400	10 800	9 100	32,0
34,0	81,7	129,0	13 100	10 600	9 100	13 100	10 600	9 100	34,0
36,0	80,8	128,5	12 800	10 400	9 100	12 800	10 400	9 100	36,0
38,0	79,9	127,9	12 500	10 200	9 100	12 500	10 200	9 100	38,0
40,0	79,0	127,4	12 200	10 000	9 000	12 200	10 000	9 000	40,0
42,0	78,0	126,7	11 900	9 800	8 900	11 900	9 800	8 900	42,0
44,0	77,1	126,1	11 600	9 600	8 700	11 600	9 600	8 700	44,0
46,0	76,2	125,3	11 400	9 400	8 600	11 400	9 400	8 600	46,0
48,0	75,3	124,6	11 100	9 300	8 400	11 100	9 300	8 400	48,0
50,0	74,3	123,8	10 800	9 100	8 300	10 800	9 100	8 300	50,0
52,0	73,4	123,0	10 600	8 900	8 100	10 600	8 900	8 100	52,0
54,0	72,4	122,2	10 300	8 700	8 000	10 300	8 700	8 000	54,0
56,0	71,5	121,3	10 100	8 500	7 800	10 100	8 500	7 800	56,0
58,0	70,5	120,3	9 900	8 300	7 700	9 900	8 300	7 700	58,0
60,0	69,5	119,4	9 700	8 200	7 600	9 700	8 200	7 600	60,0
62,0	68,5	118,3	9 500	8 000	7 400	9 500	8 000	7 400	62,0
64,0	67,5	117,3	9 200	7 900	7 300	9 200	7 900	7 300	64,0
66,0	66,5	116,2	9 000	7 700	7 200	9 000	7 700	7 200	66,0
68,0	65,5	115,0	8 800	7 600	7 000	8 800	7 600	7 000	68,0
70,0	64,5	113,8	8 700	7 400	6 900	8 700	7 400	6 900	70,0
72,0	63,5	112,6	8 500	7 300	6 800	8 500	7 300	6 800	72,0
74,0	62,4	111,2	8 300	7 100	6 600	8 300	7 100	6 600	74,0
76,0	61,4	109,9	8 100	7 000	6 500	8 100	7 000	6 500	76,0
78,0	60,3	108,5	8 000	6 900	6 400	8 000	6 900	6 400	78,0
80,0	59,2	107,0	7 800	6 700	6 300	7 800	6 700	6 300	80,0
82,0	58,1	105,5	7 600	6 600	6 200	7 600	6 600	6 200	82,0
84,0	57,0	103,9	7 500	6 500	6 100	7 500	6 500	6 100	84,0
88,0	54,7	100,5	7 200	6 300	5 900	7 200	6 300	5 900	88,0
92,0	52,3	96,9	6 900	6 100	5 700	6 900	6 100	5 700	92,0
96,0	49,9	92,9	6 700	5 900	5 500	6 700	5 900	5 500	96,0
100,0	47,3	88,5	6 400	5 700	5 400	6 400	5 700	5 400	100,0
104,0	44,5	83,7	6 200	5 500	5 200	6 200	5 500	5 200	104,0
108,0	41,6	78,4	6 000	5 300	5 100	6 000	5 300	5 100	108,0
112,0	38,5	72,5	5 800	5 200	4 900	5 900	5 200	4 900	112,0
116,0	35,1	65,8	4 700	4 400	4 100	5 700	5 100	4 800	116,0
120,0	31,3	58,0	3 600			5 600	5 000	4 700	120,0
124,0	26,8	48,5				5 500	4 900	4 700	124,0
128,0									128,0

# MLC300 VPC-MAX S-2

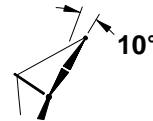
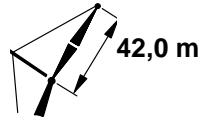
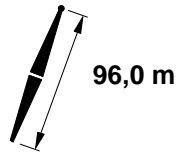

m	°	m	10,6 m		14,6 m		m
			0°		1°		
			kg	kg	kg	kg	
21,3	84,7	138,8	17 200		17 200		21,3
22,0	84,4	138,8	17 100		17 100		22,0
24,0	83,5	138,4	16 900		16 900		24,0
26,0	82,7	138,1	16 700	13 200	16 700	13 200	26,0
28,0	81,8	137,7	16 400	13 200	16 400	13 200	28,0
30,0	81,0	137,3	16 200	13 100	16 200	13 100	30,0
32,0	80,2	136,9	15 900	12 800	15 900	12 800	32,0
34,0	79,3	136,4	15 600	12 600	15 600	12 600	34,0
36,0	78,4	135,9	15 200	12 400	15 200	12 400	36,0
38,0	77,6	135,4	14 900	12 100	14 900	12 100	38,0
40,0	76,7	134,8	14 600	11 900	14 600	11 900	40,0
42,0	75,9	134,2	14 200	11 700	14 200	11 700	42,0
44,0	75,0	133,6	13 900	11 400	13 900	11 400	44,0
46,0	74,1	132,9	13 600	11 200	13 600	11 200	46,0
48,0	73,2	132,2	13 300	11 000	13 300	11 000	48,0
50,0	72,4	131,5	13 000	10 800	13 000	10 800	50,0
52,0	71,5	130,7	12 700	10 500	12 700	10 500	52,0
54,0	70,6	129,9	12 400	10 300	12 400	10 300	54,0
56,0	69,7	129,1	12 100	10 100	12 100	10 100	56,0
58,0	68,8	128,2	11 800	9 900	11 800	9 900	58,0
60,0	67,9	127,3	11 500	9 700	11 500	9 700	60,0
62,0	66,9	126,3	11 300	9 500	11 300	9 500	62,0
64,0	66,0	125,3	11 000	9 300	11 000	9 300	64,0
66,0	65,1	124,3	10 700	9 100	10 700	9 100	66,0
68,0	64,1	123,2	10 500	9 000	10 500	9 000	68,0
70,0	63,2	122,1	10 300	8 800	10 300	8 800	70,0
72,0	62,2	120,9	10 000	8 600	10 000	8 600	72,0
74,0	61,2	119,7	9 800	8 400	9 800	8 400	74,0
76,0	60,3	118,5	9 600	8 200	9 600	8 200	76,0
78,0	59,3	117,2	9 400	8 100	9 400	8 100	78,0
80,0	58,3	115,8	9 200	7 900	9 200	7 900	80,0
82,0	57,3	114,4	9 000	7 700	9 000	7 700	82,0
84,0	56,2	112,9	8 800	7 600	8 800	7 600	84,0
88,0	54,1	109,9	8 400	7 300	8 400	7 300	88,0
92,0	52,0	106,5	8 000	7 000	8 000	7 000	92,0
96,0	49,7	102,9	7 700	6 700	7 700	6 700	96,0
100,0	47,4	99,0	7 400	6 500	7 400	6 500	100,0
104,0	45,0	94,8	6 600	6 100	7 100	6 200	104,0
108,0	42,5	90,1	5 400	4 900	6 800	6 000	108,0
112,0	39,8	85,0	4 300	3 900	6 500	5 800	112,0
116,0	36,9	79,4	3 300		6 300	5 600	116,0
120,0	33,8	73,1			6 100	5 400	120,0
124,0	30,4	66,0			5 900	5 200	124,0
128,0	26,6	57,6			5 700	5 100	128,0
132,0	22,0	47,4			5 500	4 900	132,0

# MLC300 VPC-MAX S-2

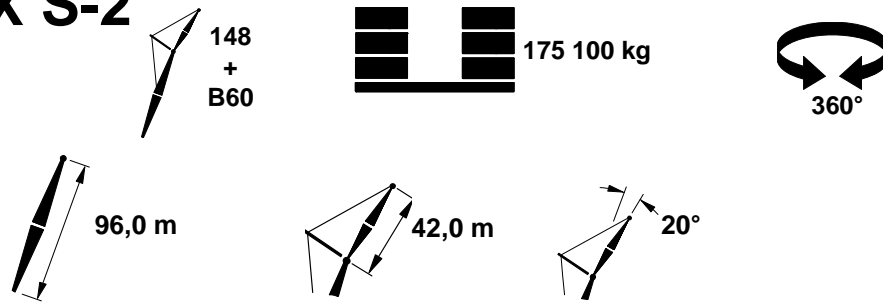

m	°	m	10,6 m		14,6 m		m
			0°		1°		
			kg	kg	kg	kg	
21,3							21,3
22,0							22,0
24,0							24,0
26,0							26,0
28,0	84,6	136,5	14 000		14 000		28,0
30,0	83,8	136,1	13 700		13 700		30,0
32,0	82,9	135,7	13 400	10 800	13 400	10 800	32,0
34,0	82,1	135,2	13 100	10 600	13 100	10 600	34,0
36,0	81,2	134,7	12 800	10 400	12 800	10 400	36,0
38,0	80,3	134,2	12 500	10 200	12 500	10 200	38,0
40,0	79,5	133,6	12 300	10 100	12 300	10 100	40,0
42,0	78,6	133,0	12 000	9 900	12 000	9 900	42,0
44,0	77,7	132,4	11 700	9 700	11 700	9 700	44,0
46,0	76,8	131,7	11 500	9 500	11 500	9 500	46,0
48,0	75,9	131,0	11 200	9 300	11 200	9 300	48,0
50,0	75,0	130,2	11 000	9 200	11 000	9 200	50,0
52,0	74,1	129,5	10 800	9 000	10 800	9 000	52,0
54,0	73,2	128,7	10 500	8 800	10 500	8 800	54,0
56,0	72,3	127,8	10 300	8 600	10 300	8 600	56,0
58,0	71,4	126,9	10 100	8 500	10 100	8 500	58,0
60,0	70,5	126,0	9 900	8 300	9 900	8 300	60,0
62,0	69,6	125,0	9 600	8 200	9 600	8 200	62,0
64,0	68,6	124,0	9 500	8 000	9 500	8 000	64,0
66,0	67,7	123,0	9 300	7 900	9 300	7 900	66,0
68,0	66,7	121,9	9 100	7 700	9 100	7 700	68,0
70,0	65,8	120,8	8 900	7 600	8 900	7 600	70,0
72,0	64,8	119,6	8 700	7 400	8 700	7 400	72,0
74,0	63,8	118,4	8 500	7 300	8 500	7 300	74,0
76,0	62,8	117,1	8 300	7 200	8 300	7 200	76,0
78,0	61,8	115,8	8 200	7 000	8 200	7 000	78,0
80,0	60,8	114,4	8 000	6 900	8 000	6 900	80,0
82,0	59,8	113,0	7 900	6 800	7 900	6 800	82,0
84,0	58,7	111,5	7 700	6 700	7 700	6 700	84,0
88,0	56,6	108,3	7 400	6 400	7 400	6 400	88,0
92,0	54,4	105,0	7 200	6 200	7 200	6 200	92,0
96,0	52,1	101,3	6 900	6 000	6 900	6 000	96,0
100,0	49,8	97,3	6 700	5 800	6 700	5 800	100,0
104,0	47,3	93,0	6 500	5 700	6 500	5 700	104,0
108,0	44,7	88,3	6 100	5 400	6 200	5 500	108,0
112,0	42,0	83,1	4 900	4 500	6 100	5 300	112,0
116,0	39,0	77,3	3 800		5 900	5 200	116,0
120,0	35,9	70,8			5 800	5 100	120,0
124,0	32,3	63,4			5 600	5 000	124,0
128,0	28,3	54,6			5 600	4 900	128,0
132,0							132,0



# MLC300 VPC-MAX S-2

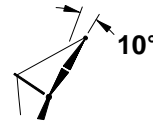
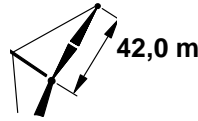
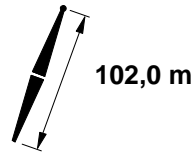

m	°	m	10,6 m		14,6 m		m
			0°		1°		
			kg	kg	kg	kg	
21,3	84,9	144,9	16 600		16 600		21,3
22,0	84,6	144,8	16 500		16 500		22,0
24,0	83,8	144,5	16 300		16 300		24,0
26,0	83,0	144,2	16 100	11 000	16 100	11 000	26,0
28,0	82,2	143,8	15 900	11 000	15 900	11 000	28,0
30,0	81,4	143,4	15 700	11 000	15 700	11 000	30,0
32,0	80,6	143,0	15 400	11 000	15 400	11 000	32,0
34,0	79,8	142,5	15 200	11 000	15 200	11 000	34,0
36,0	78,9	142,1	15 000	11 000	15 000	11 000	36,0
38,0	78,1	141,6	14 700	11 000	14 700	11 000	38,0
40,0	77,3	141,0	14 500	11 000	14 500	11 000	40,0
42,0	76,5	140,4	14 200	11 000	14 200	11 000	42,0
44,0	75,6	139,8	13 900	11 000	13 900	11 000	44,0
46,0	74,8	139,2	13 600	10 900	13 600	10 900	46,0
48,0	74,0	138,5	13 300	10 700	13 300	10 700	48,0
50,0	73,1	137,8	13 000	10 500	13 000	10 500	50,0
52,0	72,3	137,1	12 700	10 300	12 700	10 300	52,0
54,0	71,4	136,4	12 500	10 100	12 500	10 100	54,0
56,0	70,6	135,6	12 200	9 900	12 200	9 900	56,0
58,0	69,7	134,7	11 900	9 800	11 900	9 800	58,0
60,0	68,8	133,8	11 600	9 600	11 600	9 600	60,0
62,0	68,0	132,9	11 400	9 400	11 400	9 400	62,0
64,0	67,1	132,0	11 100	9 200	11 100	9 200	64,0
66,0	66,2	131,0	10 900	9 100	10 900	9 100	66,0
68,0	65,3	130,0	10 700	8 900	10 700	8 900	68,0
70,0	64,4	128,9	10 400	8 700	10 400	8 700	70,0
72,0	63,5	127,8	10 200	8 500	10 200	8 500	72,0
74,0	62,6	126,7	10 000	8 400	10 000	8 400	74,0
76,0	61,7	125,5	9 800	8 200	9 800	8 200	76,0
78,0	60,7	124,3	9 600	8 100	9 600	8 100	78,0
80,0	59,8	123,0	9 400	7 900	9 400	7 900	80,0
82,0	58,8	121,7	9 200	7 800	9 200	7 800	82,0
84,0	57,9	120,3	9 000	7 600	9 000	7 600	84,0
88,0	55,9	117,4	8 600	7 400	8 600	7 400	88,0
92,0	53,9	114,3	8 300	7 100	8 300	7 100	92,0
96,0	51,8	110,9	7 900	6 800	7 900	6 800	96,0
100,0	49,7	107,3	7 300	6 600	7 600	6 600	100,0
104,0	47,4	103,4	6 100	5 500	7 300	6 400	104,0
108,0	45,1	99,2	4 900	4 400	7 100	6 100	108,0
112,0	42,7	94,7	3 800	3 300	6 800	5 900	112,0
116,0	40,2	89,7			6 500	5 700	116,0
120,0	37,5	84,2			6 300	5 500	120,0
124,0	34,6	78,0			6 100	5 400	124,0
128,0	31,4	71,2			5 900	5 200	128,0
132,0	27,9	63,3			5 700	5 100	132,0
136,0	23,8	53,9			5 600	4 900	136,0
140,0	18,8	41,9			5 200	4 800	140,0

# MLC300 VPC-MAX S-2

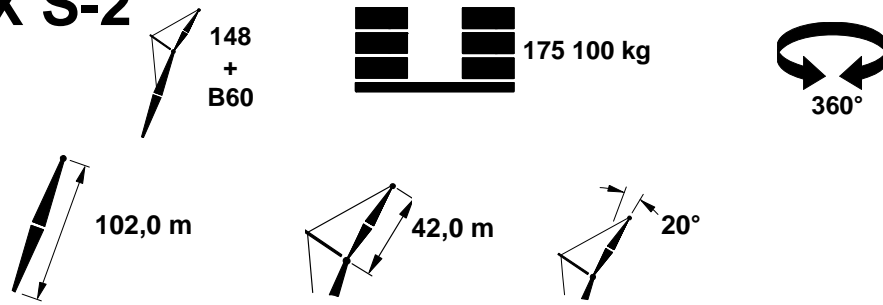

m	°	m	10,6 m		14,6 m		m
			0°	1°	0°	1°	
			kg	kg	kg	kg	
21,3							21,3
22,0							22,0
24,0							24,0
26,0							26,0
28,0							28,0
30,0	84,0	142,2	13 500		13 500		30,0
32,0	83,2	141,8	13 300	9 600	13 300	9 600	32,0
34,0	82,4	141,3	13 000	9 600	13 000	9 600	34,0
36,0	81,6	140,8	12 800	9 600	12 800	9 600	36,0
38,0	80,7	140,3	12 500	9 600	12 500	9 600	38,0
40,0	79,9	139,8	12 200	9 600	12 200	9 600	40,0
42,0	79,1	139,2	12 000	9 600	12 000	9 600	42,0
44,0	78,2	138,6	11 800	9 600	11 800	9 600	44,0
46,0	77,4	138,0	11 500	9 500	11 500	9 500	46,0
48,0	76,5	137,3	11 300	9 300	11 300	9 300	48,0
50,0	75,7	136,6	11 100	9 100	11 100	9 100	50,0
52,0	74,8	135,8	10 800	9 000	10 800	9 000	52,0
54,0	74,0	135,1	10 600	8 800	10 600	8 800	54,0
56,0	73,1	134,3	10 400	8 700	10 400	8 700	56,0
58,0	72,2	133,4	10 200	8 500	10 200	8 500	58,0
60,0	71,4	132,5	10 000	8 400	10 000	8 400	60,0
62,0	70,5	131,6	9 800	8 200	9 800	8 200	62,0
64,0	69,6	130,7	9 600	8 100	9 600	8 100	64,0
66,0	68,7	129,7	9 400	7 900	9 400	7 900	66,0
68,0	67,8	128,6	9 200	7 800	9 200	7 800	68,0
70,0	66,9	127,6	9 000	7 700	9 000	7 700	70,0
72,0	66,0	126,5	8 800	7 500	8 800	7 500	72,0
74,0	65,1	125,3	8 700	7 400	8 700	7 400	74,0
76,0	64,1	124,1	8 500	7 300	8 500	7 300	76,0
78,0	63,2	122,9	8 400	7 200	8 400	7 200	78,0
80,0	62,2	121,6	8 200	7 000	8 200	7 000	80,0
82,0	61,3	120,2	8 000	6 900	8 000	6 900	82,0
84,0	60,3	118,8	7 900	6 800	7 900	6 800	84,0
88,0	58,3	115,9	7 600	6 600	7 600	6 600	88,0
92,0	56,2	112,8	7 400	6 400	7 400	6 400	92,0
96,0	54,1	109,4	7 100	6 200	7 100	6 200	96,0
100,0	52,0	105,7	6 900	6 000	6 900	6 000	100,0
104,0	49,7	101,7	6 600	5 800	6 600	5 800	104,0
108,0	47,4	97,4	5 700	5 100	6 500	5 700	108,0
112,0	44,9	92,8	4 500	4 000	6 300	5 500	112,0
116,0	42,3	87,7	3 400		6 100	5 400	116,0
120,0	39,5	82,0			5 900	5 200	120,0
124,0	36,5	75,7			5 800	5 100	124,0
128,0	33,3	68,6			5 700	5 000	128,0
132,0	29,6	60,4			5 600	5 000	132,0
136,0							136,0
140,0							140,0

# MLC300 VPC-MAX S-2

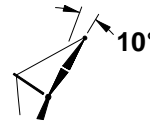
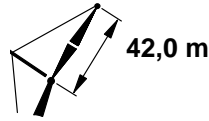
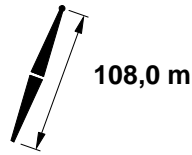

			10,6 m		14,6 m	
			0°		0°	
			kg		kg	
m	°	m	kg		m	
22,9	84,6	150,8	15 400	15 400	22,9	
24,0	84,2	150,6	15 300	15 300	24,0	
26,0	83,4	150,3	15 100	15 100	26,0	
28,0	82,6	150,0	14 900	14 900	28,0	
30,0	81,9	149,6	14 700	14 700	30,0	
32,0	81,1	149,2	14 500	14 500	32,0	
34,0	80,3	148,8	14 400	14 400	34,0	
36,0	79,5	148,3	14 200	14 200	36,0	
38,0	78,7	147,8	14 000	14 000	38,0	
40,0	78,0	147,3	13 800	13 800	40,0	
42,0	77,2	146,8	13 600	13 600	42,0	
44,0	76,4	146,2	13 400	13 400	44,0	
46,0	75,6	145,6	13 100	13 100	46,0	
48,0	74,8	145,0	12 800	12 800	48,0	
50,0	74,0	144,3	12 600	12 600	50,0	
52,0	73,2	143,6	12 300	12 300	52,0	
54,0	72,3	142,9	12 100	12 100	54,0	
56,0	71,5	142,1	11 800	11 800	56,0	
58,0	70,7	141,4	11 600	11 600	58,0	
60,0	69,9	140,5	11 300	11 300	60,0	
62,0	69,1	139,7	11 100	11 100	62,0	
64,0	68,2	138,8	10 900	10 900	64,0	
66,0	67,4	137,9	10 700	10 700	66,0	
68,0	66,5	136,9	10 500	10 500	68,0	
70,0	65,7	135,9	10 200	10 200	70,0	
72,0	64,8	134,9	10 000	10 000	72,0	
74,0	63,9	133,8	9 800	9 800	74,0	
76,0	63,1	132,7	9 600	9 600	76,0	
78,0	62,2	131,5	9 400	9 400	78,0	
80,0	61,3	130,3	9 200	9 200	80,0	
82,0	60,4	129,1	9 100	9 100	82,0	
84,0	59,5	127,8	8 900	8 900	84,0	
88,0	57,6	125,1	8 500	8 500	88,0	
92,0	55,8	122,2	8 200	8 200	92,0	
96,0	53,8	119,1	7 800	7 900	96,0	
100,0	51,8	115,7	6 400	7 600	100,0	
104,0	49,8	112,1	5 100	7 300	104,0	
108,0	47,7	108,3	4 000	7 000	108,0	
112,0	45,5	104,1		6 800	112,0	
116,0	43,2	99,6		6 600	116,0	
120,0	40,8	94,7		6 300	120,0	
124,0	38,2	89,4		6 100	124,0	
128,0	35,5	83,5		5 900	128,0	
132,0	32,6	76,9		5 800	132,0	
136,0	29,3	69,5		5 400	136,0	
140,0	25,7	60,9		4 600	140,0	
144,0	21,4	50,4		3 800	144,0	

# MLC300 VPC-MAX S-2

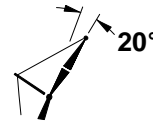
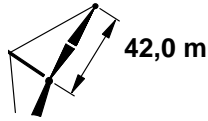
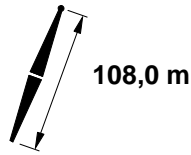

m	°	m	10,6 m		14,6 m	
			kg	kg	kg	kg
22,9						22,9
24,0						24,0
26,0						26,0
28,0						28,0
30,0	84,4	148,3	12 900	12 900		30,0
32,0	83,6	147,9	12 700	12 700		32,0
34,0	82,8	147,5	12 400	12 400		34,0
36,0	82,1	147,1	12 200	12 200		36,0
38,0	81,3	146,6	12 000	12 000		38,0
40,0	80,5	146,1	11 800	11 800		40,0
42,0	79,7	145,5	11 500	11 500		42,0
44,0	78,9	144,9	11 300	11 300		44,0
46,0	78,1	144,3	11 100	11 100		46,0
48,0	77,3	143,7	10 900	10 900		48,0
50,0	76,4	143,0	10 700	10 700		50,0
52,0	75,6	142,3	10 500	10 500		52,0
54,0	74,8	141,6	10 300	10 300		54,0
56,0	74,0	140,8	10 100	10 100		56,0
58,0	73,2	140,0	9 900	9 900		58,0
60,0	72,3	139,2	9 700	9 700		60,0
62,0	71,5	138,3	9 500	9 500		62,0
64,0	70,6	137,4	9 300	9 300		64,0
66,0	69,8	136,5	9 200	9 200		66,0
68,0	68,9	135,5	9 000	9 000		68,0
70,0	68,1	134,5	8 800	8 800		70,0
72,0	67,2	133,5	8 600	8 600		72,0
74,0	66,3	132,4	8 500	8 500		74,0
76,0	65,4	131,3	8 300	8 300		76,0
78,0	64,6	130,1	8 200	8 200		78,0
80,0	63,7	128,9	8 100	8 100		80,0
82,0	62,7	127,6	7 900	7 900		82,0
84,0	61,8	126,3	7 800	7 800		84,0
88,0	60,0	123,6	7 500	7 500		88,0
92,0	58,0	120,6	7 200	7 200		92,0
96,0	56,1	117,5	7 000	7 000		96,0
100,0	54,1	114,1	6 800	6 800		100,0
104,0	52,0	110,5	6 100	6 600		104,0
108,0	49,8	106,6	4 800	6 400		108,0
112,0	47,6	102,3	3 700	6 200		112,0
116,0	45,3	97,7		6 000		116,0
120,0	42,8	92,8		5 900		120,0
124,0	40,2	87,3		5 700		124,0
128,0	37,4	81,2		5 600		128,0
132,0	34,4	74,5		5 500		132,0
136,0	31,0	66,7		5 400		136,0
140,0	27,2	57,7		4 800		140,0
144,0						144,0