

## MDT 389 L12

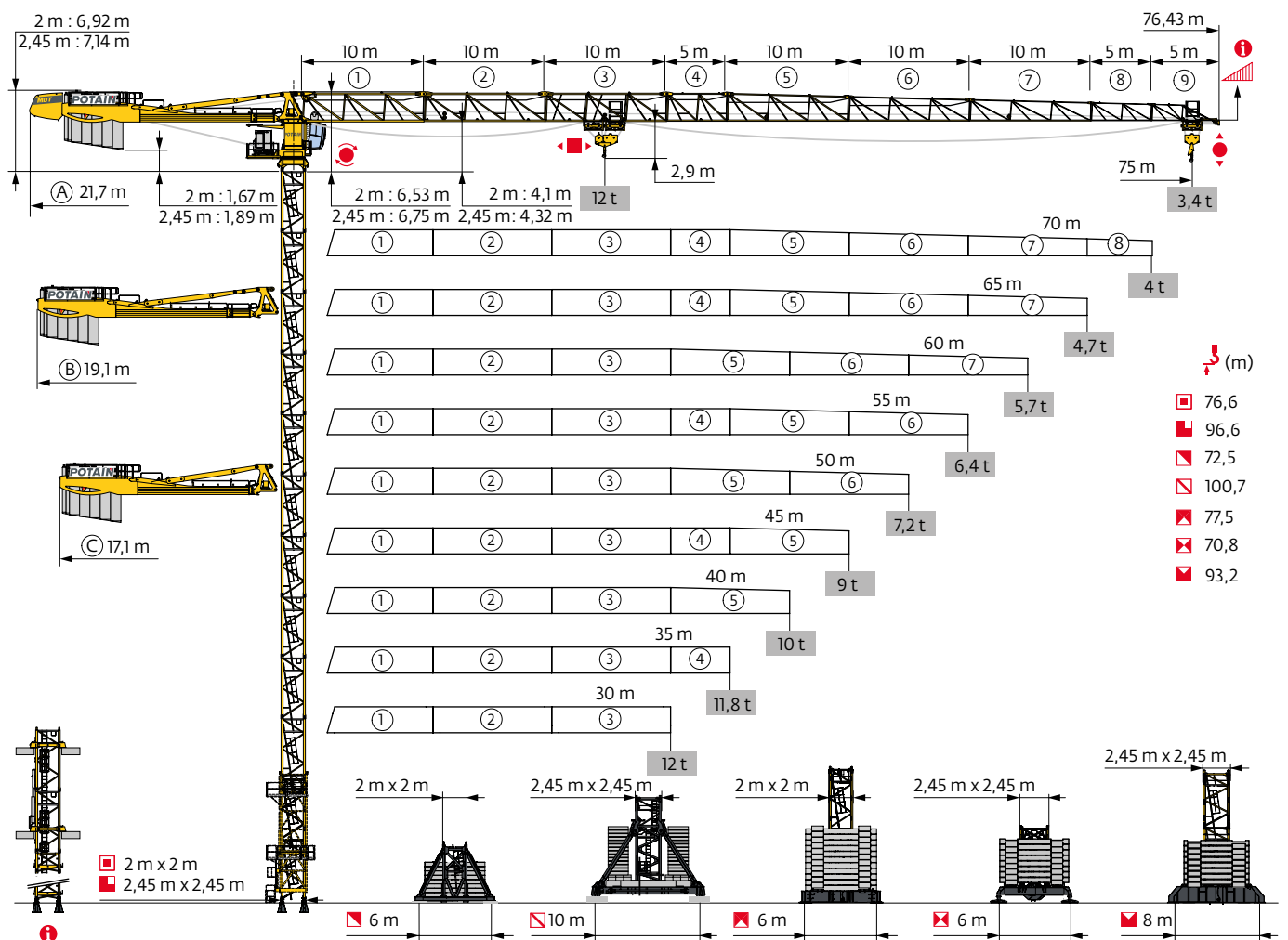

Potain Plus



Power Control

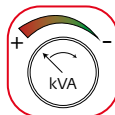

POTAIN® CONNECT



Top Site

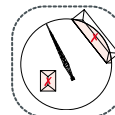

Anti-collision systems

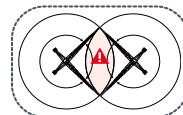

Automatic Rotation Control



Mât - Réactions / Mast - Reaktionskräfte / Mast - Reactions / Mástil - Reacciones / Torre - Reazioni  
 Tramo - Reacções / Реакция опор мачты

**2 m - P 63A**

ΔΔΔΔ (m)	30	35	40	45	50	55	60	65	70	75
↕ (m)	76,6	69,9	69,9	71,6	71,6	71,6	73,2	71,6	71,6	71,6
↕/P+ (m)	76,6	61,6	61,6	63,2	66,6	63,2	71,6	69,9	68,2	68,2
	3,33 m	0	1	1	0	0	2	0	0	0
	5 m	13	11	11	12	12	11	12	12	12
	10 m	1	1	1	1	1	1	1	1	1
F2 (t)	● 222	211	210	216	218	217	221	219	225	226
	■ 295	249	249	258	265	267	284	277	284	291
F3 (t)	● 159	149	147	151	152	151	155	152	157	158
	■ 238	193	193	199	206	207	224	216	222	229

**2 m - V 60A**

ΔΔΔΔ (m)	30	35	40	45	50	55	60	65	70	75
↕ (m)	72,5	65,9	67,5	69,2	69,2	69,2	70,9	69,2	69,2	69,2
↕/P+ (m)	72,5	60,9	60,9	60,9	65,9	60,9	69,2	65,9	65,9	65,9
	3,33 m	2	0	2	1	1	1	0	1	1
	5 m	12	12	11	12	12	12	13	12	12
	F1 (t)	● 121	108	110	112	112	112	119	119	122
	■ 148	119	127	131	135	136	145	142	148	153

**2 m - ZX 640**

ΔΔΔΔ (m)	30	35	40	45	50	55	60	65	70	75
↕ (m)	77,5	69,2	70,9	70,9	70,9	70,9	72,5	70,9	72,5	72,5
↕/P+ (m)	77,5	62,5	62,5	62,5	67,5	62,5	70,9	67,5	69,2	67,5
	3,33 m	0	2	1	1	1	0	1	0	0
	5 m	13	10	11	11	11	12	11	12	12
	10 m	1	1	1	1	1	1	1	1	1
F1 (t)	● 134	116	118	119	120	120	124	123	132	135
	■ 171	135	142	139	143	144	154	150	162	166

**2,45 m - P 800B**

ΔΔΔΔ (m)	30	35	40	45	50	55	60	65	70	75
↕ (m)	81,6	81,6	81,6	81,6	79,9	79,9	79,9	78,2	78,2	76,6
↕/P+ (m)	81,6	81,6	81,6	81,6	79,9	79,9	79,9	78,2	78,2	76,6
	3,33 m	0	0	0	1	1	1	2	2	0
	5 m	16	16	16	16	15	15	15	14	15
	F2 (t)	● 211	222	220	220	215	216	211	218	220
	■ 326	330	330	328	323	324	327	323	331	317
F3 (t)	● 138	146	144	142	137	138	133	139	140	137
	■ 259	261	260	255	252	252	255	250	257	245

**2,45 m - P 854A**

ΔΔΔΔ (m)	30	35	40	45	50	55	60	65	70	75
↕ (m)	96,6	96,6	96,6	96,6	96,6	96,6	96,6	96,6	94,9	93,2
↕/P+ (m)	96,6	96,6	96,6	96,6	96,6	96,6	96,6	96,6	94,9	93,2
	3,33 m	0	0	0	0	0	0	0	1	2
	5 m	19	19	19	19	19	19	19	19	18
	F2 (t)	● 263	273	272	272	270	271	266	279	277
	■ 471	476	476	474	479	481	482	489	485	479
F3 (t)	● 181	186	184	182	181	181	178	189	187	184
	■ 395	395	394	390	396	397	401	405	401	396

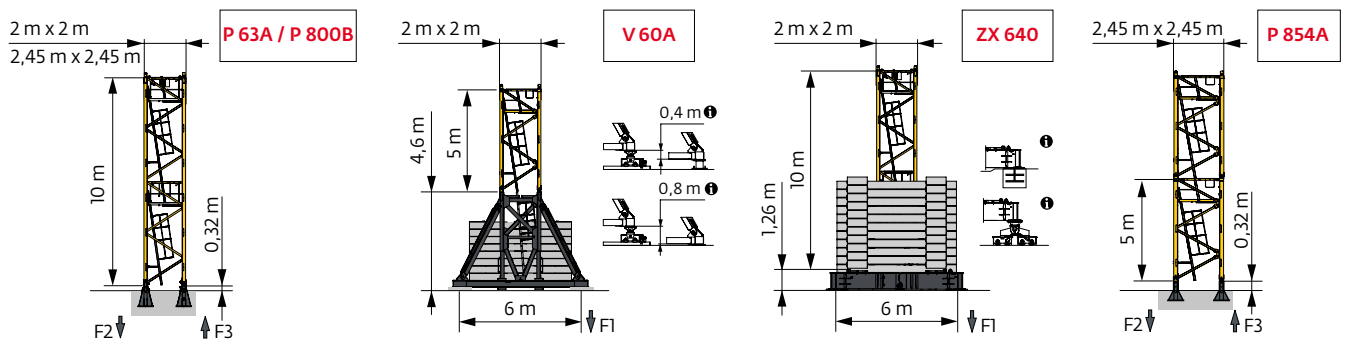

**2,45 m - JM 850**

Δ (m)	30	35	40	45	50	55	60	65	70	75
↓ (m)	100,7	100,7	100,7	100,7	100,7	99	99	97,3	97,3	95,7
↓/P+ (m)	100,7	100,7	100,7	100,7	100,7	99	99	97,3	97,3	95,7
3,33 m	0	0	0	0	0	1	1	2	2	0
5 m	18	18	18	18	18	17	17	16	16	17
FI (t)	● 147	150	150	151	150	147	145	147	148	140
	■ 229	230	230	228	231	226	227	224	228	210

**2,45 m - ZX 6830**

Δ (m)	30	35	40	45	50	55	60	65	70	75
↓ (m)	70,8	70,8	70,8	70,8	70,8	70,8	69,2	69,2	67,5	67,5
↓/P+ (m)	70,8	70,8	70,8	70,8	70,8	70,8	69,2	69,2	67,5	67,5
3,33 m	1	1	1	1	1	1	2	2	0	0
5 m	13	13	13	13	13	13	12	12	13	13
FI (t)	● 129	134	134	131	133	134	128	132	130	131
	■ 170	172	172	169	173	174	169	173	166	171

**2,45 m - ZY 800**

Δ (m)	30	35	40	45	50	55	60	65	70	75
↓ (m)	77,9	77,9	77,9	77,9	77,9	77,9	77,9	77,9	76,3	74,6
↓/P+ (m)	77,9	77,9	77,9	77,9	77,9	77,9	77,9	77,9	76,3	74,6
3,33 m	0	0	0	0	0	0	0	0	1	2
5 m	15	15	15	15	15	15	15	15	14	13
FI (t)	● 124	128	125	126	126	126	128	132	131	127
	■ 169	170	171	169	174	174	177	182	181	178

**2,45 m - ZY 854**

Δ (m)	30	35	40	45	50	55	60	65	70	75
↓ (m)	93,2	93,2	93,2	93,2	93,2	93,2	93,2	93,2	91,5	89,9
↓/P+ (m)	93,2	93,2	93,2	93,2	93,2	93,2	93,2	93,2	91,5	89,9
3,33 m	0	0	0	0	0	0	0	0	1	2
5 m	18	18	18	18	18	18	18	18	17	16
FI (t)	● 170	174	174	172	175	175	174	179	179	174
	■ 258	257	257	256	261	262	267	270	270	265

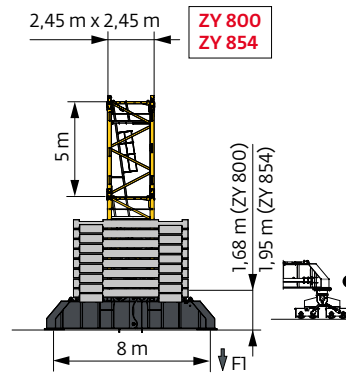
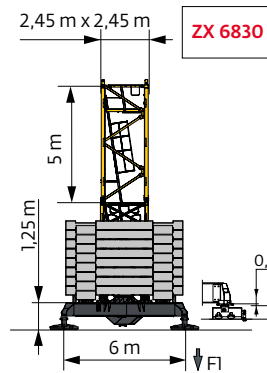
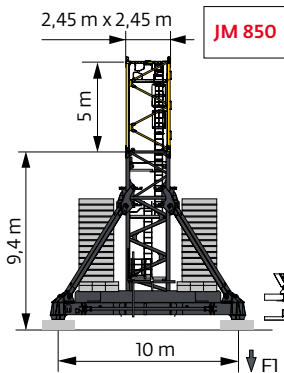

**i** Autres compositions de pylône - Nous consulter. / Andere Turmaufbauten - bitte kontaktieren Sie uns. / Other mast compositions - Please consult us. / Para otras composiciones de mástil - Por favor contáctenos. / Per altre composizioni torre, contattateci. / Para outras composições de coluna - Por favor, consulte-nos. / Для других композиций мачты пожалуйста консультируйтесь с нами.

Accès motorisés : compositions de mâture, de lest de base et réactions adaptées. / Motorisierter Zugang vom : Mastzusammensetzung, Grundballast und Reaktionskräfte sind angepasst. / Motorized accesses: adapted mast composition, base ballast and reactions. / Acceso a cabina con elevador: Adaptación de composición de mástil, lastre de base y reacciones. / Accessi motorizzati: composizioni elementi torre, zavorre di base e reazioni aggiornate. / Acessos motorizados: composições de coluna, lastro da base e reações adaptadas. / Лифты : адаптированная композиция мачты, базовый балласт и нагрузки.

Ancrages / Verankerungen / Anchorages / Anclajes / Ancoraggi  
Ancoragem / нкпа

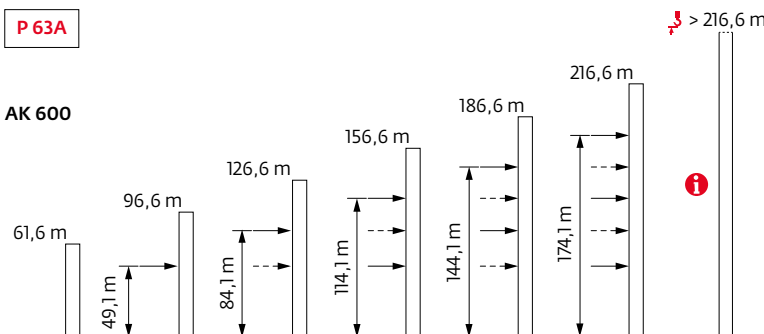

Lest de base / Grundballast / Base ballast / Lastre de base / Zavorra di base  
 Lastro da base / Базовый Балласт

**⚖️ (t) / 📏 2 m - V 60A - 🏗️**

▲▼▲\ (m)	30	35	40	45	50	55	60	65	70	75
72,5	132									
70,9	120						120			
69,2	108			96	96	96	108	108	120	120
67,5	96		96	96	96	96	96	96	108	108
↓ 65,9 (m)	96	96	96	96	96	96	84	84	96	108
60,9	84	108	108	96	96	96	84	84	84	72
55,9	72	96	96	96	84	84	72	72	72	72
50,9	60	96	96	84	84	84	60	72	60	60
45,9	60	84	84	84	72	72	60	60	60	60
40,9	60	84	84	84	72	72	48	48	48	48

**⚖️ (t) / 📏 2 m - ZX 640 - 🏗️**

▲▼▲\ (m)	30	35	40	45	50	55	60	65	70	75
77,5	160									
72,5	120						120		140	150
70,9	110		110	110	110	110	110	120	120	130
69,2	100	110	110	100	100	100	100	110	110	120
↓ 64,2 (m)	100	100	100	100	100	90	90	90	90	90
59,2	90	110	110	100	90	100	90	80	80	80
54,2	80	100	100	100	90	90	80	80	70	70
49,2	60	100	100	90	80	90	70	70	60	60
44,2	60	90	90	80	70	80	60	60	50	50
39,2	50	90	80	80	60	70	50	50	40	50

**⚖️ (t) / 📏 2,45 m - JM 850 - 🏗️**

▲▼▲\ (m)	30	35	40	45	50	55	60	65	70	75
100,7	180	180	180	180	180					
99	180	180	168	168	168	168	168			
97,3	168	168	168	156	168	156	168	168	168	
95,7	144	144	132	132	132	132	132	132	144	144
↓ 90,7 (m)	120	120	108	108	108	108	108	108	120	120
85,7	96	84	84	84	84	84	84	84	96	96
80,7	72	72	60	60	60	60	60	60	72	72
75,7 ↓	48	48	48	48	48	48	48	48	48	48
45,7	48	48	48	48	48	48	48	48	48	48

**⚖️ (t) / 📏 2,45 m - ZX 6830 - 🏗️**

▲▼▲\ (m)	30	35	40	45	50	55	60	65	70	75
70,8	151	151	151	141	151	151				
69,2	141	141	141	131	141	141	141	141		
↓ 67,5 (m)	131	131	121	121	121	121	131	131	141	141
62,5	91	101	101	101	91	91	91	91	101	111
57,5	61	91	91	81	71	81	61	61	71	71
52,5	51	81	81	81	61	71	51	51	51	51
47,5	51	81	81	81	61	71	51	51	41	51

**⚖️ (t) / 📏 2,45 m - ZY 800 - 🏗️**

▲▼▲\ (m)	30	35	40	45	50	55	60	65	70	75
77,9	120	120	108	108	108	108	120	120		
76,3	108	108	108	96	108	108	108	108	120	
74,6	96	96	96	96	96	96	96	96	108	108
69,6	72	72	72	60	72	72	72	72	72	84
↓ 64,6 (m)	48	48	48	48	36	36	48	48	48	60
59,6	24	48	36	36	24	36	24	24	24	24
54,6	12	36	36	24	24	24	12	12	12	12
49,6 ↓	12	36	24	24	12	12	12	12	12	12
34,6	12	36	24	24	12	12	12	12	12	12

**⚖️ (t) / 📏 2,45 m - ZY 854 - 🏗️**

▲▼▲\ (m)	30	35	40	45	50	55	60	65	70	75
93,2	216	216	216	204	216	216	216	216		
91,5	204	204	204	192	204	204	204	204	216	
89,9	192	192	192	180	192	192	192	204	204	204
84,9	156	156	156	144	156	156	156	156	168	168
79,9	120	120	120	108	120	120	120	132	132	132
↓ 74,9 (m)	96	96	96	84	84	84	84	96	96	108
69,9	60	60	60	60	60	60	60	60	72	72
64,9	36	36	36	36	36	36	36	36	48	48
59,9	12	36	24	24	12	24	12	12	24	24
54,9	12	24	24	24	12	12	12	12	12	12
49,9 ↓	12	24	12	12	12	12	12	12	12	12
34,9	12	24	12	12	12	12	12	12	12	12

Courbes de charges / Lastkurven / Load curves / Curvas de cargas / Curve di carico / Curvas de carga / Кривые нагрузок



▼▲▲▲ (m)		22	27	30	32	35	37	40	42	45	47	50	52	55	57	60	62	65	67	70	72	75	m
▼▲▲▲	↔ 12 t	↔										↔											
▼▲▲▲	↔ 6 t	↔										↔											
75	3,1 → 24,9	12	11	9,8	9,1	8,2	7,6	6,8	6,3	6	6	5,5	5,2	4,9	4,6	4,3	4,1	3,9	3,7	3,5	3,4	3,2	t
	3,1 → 26,2	12	11,6	10,2	9,3	8,4	7,7	7	6,5	6	6	5,8	5,5	5,1	4,9	4,6	4,4	4,1	3,9	3,7	3,6	3,4	t P+
70	3,1 → 26,5	12	11,7	10,4	9,7	8,7	8,1	7,3	6,8	6,2	6	5,9	5,6	5,2	5	4,6	4,4	4,2	4	3,8		t	
	3,1 → 27,5	12	12	10,8	10	8,9	8,2	7,5	7	6,4	6	6	5,9	5,5	5,2	4,9	4,7	4,4	4,2	4		t P+	
65	3,1 → 28,3	12	12	11,2	10,4	9,3	8,6	7,8	7,2	6,6	6,2	6	5,9	5,5	5,2	4,9	4,7	4,5					t
	3,1 → 29	12	12	11,5	10,5	9,4	8,7	7,9	7,4	6,8	6,4	6	6	5,8	5,5	5,1	4,9	4,7					t P+
60	3,1 → 29	12	12	11,6	10,7	9,7	9,1	8,3	7,8	7,2	6,9	6,4	6,1		6	5,9	5,6						t
	3,1 → 29,5	12	12	11,8	10,9	9,9	9,3	8,4	8	7,4	7	6,5	6,2		6	6	5,7						t P+
55	3,1 → 30,4	12	12	12	11,3	10,3	9,7	8,8	8,4	7,7	7,4	6,8	6,5	6,1									t
	3,1 → 33	12	12	12	12	11,1	10,3	9,4	8,8	8,1	7,6	7,1	6,7	6,3									t P+
50	3,1 → 30,4	12	12	12	11,4	10,3	9,7	8,9	8,4	7,7	7,4	6,9											t
	3,1 → 31,9	12	12	12	11,9	10,8	10,2	9,3	8,8	8,1	7,7	7,1											t P+
45	3,1 → 31,8	12	12	12	11,9	10,8	10,1	9,3	8,8	8,1													t
	3,1 → 34,7	12	12	12	12	11,9	11,2	10,2	9,7	9													t P+
40	3,1 → 31,2	12	12	12	11,7	10,5	9,9	9															t
	3,1 → 34	12	12	12	12	11,6	10,9	10															t P+
35	3,1 → 31,5	12	12	12	11,8	10,6																	t
	3,1 → 34,3	12	12	12	12	11,7																	t P+
30	3,1 → 29,9	12	12	11,9																			t
	3,1 → 29,9	12	12	11,9																			t P+

↔ = ↔ - 0,67 t max.



▼▲▲▲ (m)		22	27	30	32	35	37	40	42	45	47	50	52	55	57	60	62	65	67	70	72	75	m
▼▲▲▲	↔ 12 t	↔										↔											
▼▲▲▲	↔ 6 t	↔										↔											
75	2,4 → 25	12	11,1	9,9	9,2	8,2	7,6	6,9	6,4	6	5,6	5,1	4,8	4,4	4,2	3,9	3,7	3,4	3,3	3,1	2,95	2,8	t
	2,4 → 26,3	12	11,7	10,3	9,4	8,4	7,8	7	6,6	6	5,8	5,4	5,1	4,7	4,5	4,1	3,9	3,7	3,5	3,3	3,2	3	t P+
70	2,4 → 26,5	12	11,8	10,5	9,7	8,8	8,2	7,4	6,9	6,3	6	5,5	5,2	4,8	4,5	4,2	4	3,8	3,6	3,4			t
	2,4 → 27,5	12	12	10,9	10	9	8,3	7,5	7	6,4	6	5,7	5,5	5,1	4,8	4,5	4,3	4	3,8	3,6			t P+
65	2,4 → 28,4	12	12	11,3	10,5	9,4	8,7	7,8	7,3	6,7	6,3	5,9	5,6	5,1	4,9	4,6	4,4	4,1					t
	2,4 → 29,1	12	12	11,5	10,5	9,4	8,7	7,9	7,4	6,8	6,4	6	5,8	5,4	5,1	4,8	4,6	4,3					t P+
60	2,4 → 29,2	12	12	11,6	10,8	9,8	9,1	8,4	7,9	7,3	6,9	6,4	6,1		5,9	5,6	5,3						t
	2,4 → 29,6	12	12	11,8	11	9,9	9,3	8,5	8	7,4	7	6,5	6,2		6	5,7	5,4						t P+
55	2,4 → 30,5	12	12	12	11,4	10,3	9,7	8,9	8,4	7,8	7,4	6,9	6,6	6,2									t
	2,4 → 33,1	12	12	12	12	11,2	10,4	9,5	8,9	8,1	7,7	7,1	6,8	6,4									t P+
50	2,4 → 30,6	12	12	12	11,4	10,3	9,7	8,9	8,4	7,8	7,4	6,9											t
	2,4 → 32,1	12	12	12	12	10,9	10,2	9,3	8,8	8,1	7,7	7,2											t P+
45	2,4 → 32	12	12	12	12	10,8	10,2	9,4	8,9	8,2													t
	2,4 → 34,8	12	12	12	12	11,9	11,2	10,3	9,7	9													t P+
40	2,4 → 31,4	12	12	12	11,7	10,6	10	9,1															t
	2,4 → 34,1	12	12	12	12	11,7	10,9	10															t P+
35	2,4 → 31,6	12	12	12	11,8	10,7																	t
	2,4 → 34,4	12	12	12	12	11,8																	t P+
30	2,4 → 30	12	12	12																			t
	2,4 → 30	12	12	12																			t P+

↔ = ↔ - 0,19 t max.

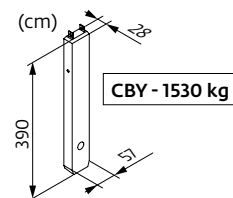
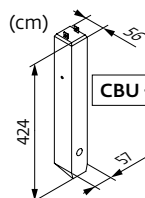
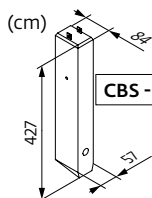

Poids de flèche & lest de contre-flèche / Auslegergewicht & Gegenauslegerballast / Jib weight & counter-jib ballast / Peso de flecha y lastre de contra-flecha/Peso del braccio & zavorra di contro-braccio/Peso da lança & lastro da contra lança/Вес стрелы и балласт контр-стрелы

▼▲▲▲	▼▲▲▲ (kg) (+/- 5%)			▨		▨			
	↔ ↔	↔	↔ ↔	4600 kg	1530 kg	▨ (kg)	3070 kg	1530 kg	▨ (kg)
75 m	18070	17675	18140	5	2	26060	8	1	26090
70 m	17805	17425	17865	5	2	26060	8	1	26090
65 m	17420	17065	17510	5	2	26060	8	1	26090
60 m	16495	16170	16565	5	1	24530	8	0	24560
55 m	16505	16185	16575	5	1	24530	8	0	24560
50 m	15690	15370	15765	5	2	26060	8	1	26090
45 m	15430	15105	15500	5	2	26060	8	1	26090
40 m	14615	14295	14685	5	0	23000	7	1	23020
35 m	14085	13765	14155	4	2	21460	7	0	21490
30 m	13245	12925	13320	4	1	19930	6	1	19950











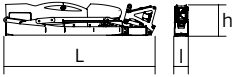

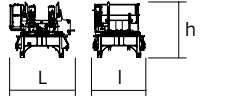
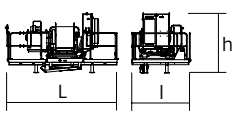
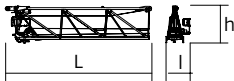
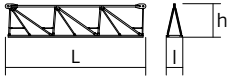
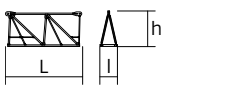
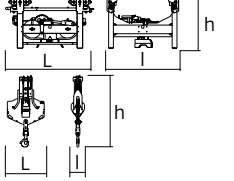
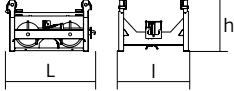
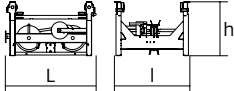
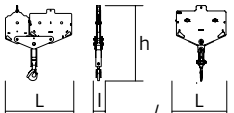
Encombrenment et poids / Abmessungen und Gewicht / Dimensions and weight / Dimensiones y peso / Ingombro e peso  
dimensões e pesos / габаритные размеры и вес

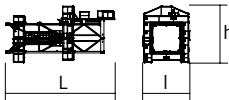
Partie tournante / Drehender Kranteil / Slewing crane part / Parte giratoria

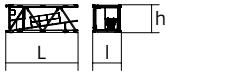
Parte rotante / Parte rotativa / Поворотная часть :  75 m -  75/90 HPL™

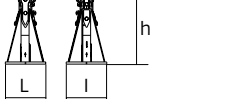
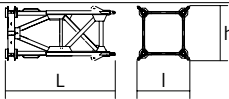
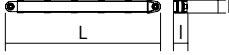
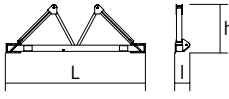
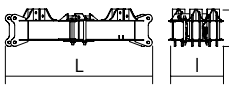
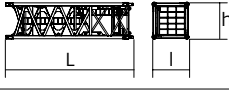
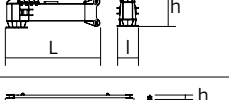
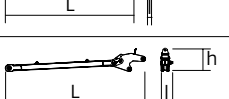

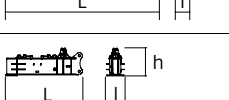
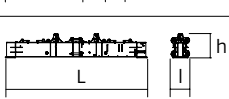
Partie tournante / Drehender Kranteil / Slewing crane part Parte giratoria / Parte rotante / Parte rotativa / Поворотная часть		L (m)	l (m)	h (m)	kg (+/- 5%)
Contre-flèche / Gegenausleger Counter-jib / Contra-flecha Controbraccio / Contra-lança Контр-стрела		12 12 12	1,25 1,25 1,25	2,5 2,5 2,5	14110 13600 11540
Mât-cabine + cabine / Kabinenmast + Kabine Cab mast + cab / Mástil-cabina + cabina Portaralla superiore + cabina / Tramo-cabina + cabina Секция мачты кабины + кабина		5,03	2,22	2,49	6720
Pivot / Krankopf Towerhead / Pivote Portaralla / Pivot Секция поворотной части		2,95 3,25	2,48 2,5	2,5 2,75	7620 8700
Treuil de levage (+ câble) / Hubwerk (+ Seil) Hoisting winch (+ rope) / Mecanismo de elevación (+ cabo) Argano di sollevamento (+ fune) Guincho de elevação (+ cabo) Подъемная лебедка (+ канатом)		4,27	2,3	2,32	4500
Elément de flèche / Auslegerelement Jib section / Elemento de flecha Elemento di braccio / Elemento de lança Секция стрелы		10,75	1,8	2,74	5450
Elément de flèche / Auslegerelement Jib section / Elemento de flecha Elemento di braccio / Elemento de lança Секция стрелы		10,21 10,31 10,22 10,24 10,19	1,2 1,2 1,2 1,2 1,2	2,5 2,42 2,39 2,1 1,83	3145 2420 1560 1235 950
Elément de flèche / Auslegerelement Jib section / Elemento de flecha Elemento di braccio / Elemento de lança Секция стрелы		5,27 5,09 5,09	1,2 1,2 1,2	2,39 1,53 1,39	960 310 220
Chariot + Moufle / Laufkatze + Hubflasche Trolley + Pulley block / Carrello + Aparejo Carro + Bozzello / Carro-distribuidor + Cadernal Тележка + Полиспаст		1,87 1,19	1,51 0,43	1,05 2,31	400 455
Chariot / Laufkatze Trolley / Carrello Carro / Carro-distribuidor Тележка		1,57	1,51	0,98	210
Chariot / Laufkatze Trolley / Carrello Carro / Carro-distribuidor тележка		1,7 1,86	1,51 1,51	1,03 0,98	245 236
Moufle / Hubflasche Pulley block / Aparejo Bozzello / Cadernal Полиспаст		1,65 1,09	0,22 0,27	1,78 1,62	450 265

Pyłõne / Kranturm / Crane tower Mástil / Torre / Torre / Башня крана		L (m)	l (m)	h (m)	kg (+/- 5%)	
T 61 T 851		10,83 11,18	4,14 4,84	4,47 5,8	9700 15750	
K 649B KM 649E KRM 6410B KRM 849B K 85/KR 84B2 KM 850.10B KM 850.14B		10,23 10,29 10,23 10,24 10,24 10,32 10,32	2,07 2,03 2,1 2,55 2,54 2,54 2,54	2,03 2,03 2,08 2,53 2,5 2,51 2,51	5290 4850 7100 7800 9635 10070 11190	
K 649A KMT 649A KR 649A KRMT 649A K 849A KMT 849A KR 849A KRMT 849A K 85/KR 84A2 KMT 850.10A KMT 850.14A		5,23 5,23 5,23 5,23 5,23 5,23 5,23 5,23 5,24 5,32 5,32	2,07 2,07 2,1 2,1 2,53 2,55 2,53 2,53 2,54 2,54 2,54	2,03 2,03 2,08 2,08 2,5 2,53 2,5 2,53 2,5 2,51 2,51	2805 2570 3250 3050 3400 3150 4290 4090 5550 5450 5990	
KRMT 649C KRMT 849C		3,57 3,57	2,1 2,55	2,08 2,53	2450 3205	
Pieds de scellement / VerankerungsfüÙe Fixing angles / Pie de empotramiento Montante da anngare / Angulos fixadores анкера		0,75 0,9	0,75 0,9	1,28 1,5	465 940	
Måt-chåssis / Grundmasteinheit Basic mast unit / Tramo-chasis Elemento base / Tramo-chassis Мачта для крепления к шасси		V 60A	5,01	2,41	2,41	4760
Haubans / Mastabstützungen / Struts / Tornapuntas Puntoni / Escoras / Растяжка		V 60A	4,51	0,29	0,29	470
Sommier / Unterwagenhälfte Half-bearer / Testero Testata / Estrutura base Траверса		V 60A	6,7	0,7	2,31	1840
Croix centrale (position transport) / Zentralkreuz (Transport- position) / Central cross (transport position) / Braço central (posición transporte) / Croce centrale (posizione di trasporto) Braço central chassis (posição transporte) / крестообразное основание (транспортное положение)		JM 850	5,2	1,7	1,5	6700
Måt-chåssis / Grundmasteinheit Basic mast unit / Tramo-chasis Elemento base / Tramo-chassis Мачта для крепления к шасси		JM 850	8,75	2,5	2,5	14600
Bras de chåssis / Unterwagenträger / Chassis girder / Braço de base en cruz / Traverse del carro / Braço de chassis / опорная балка шасси		JM 850	5,2	0,9	1,55	3200
Tirant de chåssis / Unterwagenstreben / Chassis ties / Tirante de base en cruz / Tiranti del carro / Tirante de chassis / тяга крепления шасси		JM 850	7,2	0,25	0,35	250
Haubans / Mastabstützungen / Struts / Tornapuntas Puntoni / Escoras / Растяжка		JM 850	8,2	0,75	1,3	2300
Bras de croix / Fundamentkreuzträger Cross girder / Braço en cruz / Braccio croce / Braço da cruz Поперечная балка		ZX 6830	9,1 9,1	1,12 0,76	1,1 1,48	5265 5445
1/2 Bras de croix / 1/2 Fundamentkreuzträger 1/2 Cross girder / 1/2 Braço en cruz 1/2 Braccio croce / 1/2 Braço da cruz 1/2 Поперечная балка		ZX 640 ZY 800 ZY 854	4,35 5,68 5,7	1 0,98 0,98	1,56 1,92 2,27	3320 4720 6430
Bras de croix / Fundamentkreuzträger Cross girder / Braço en cruz / Braccio croce / Braço da cruz Поперечная балка		ZX 640 ZY 800 ZY 854	9,15 11,96 11,9	1,19 1,39 1,42	1,56 1,92 2,27	6880 10075 14000

Mécanismes / Triebwerke / Mechanisms / Mecanismos / Meccanismi  
 Mecanismos / Механизмы

400 V - 50 Hz 480 V - 60 Hz													ch - PS hp	kw		
	400 V - 50 Hz	75 HPL™ 30	m/min	44	57,5	82	140	220,5	23	30	43,5	74	110	75	55	845 m
			t	6	4,5	3	1,5	0,2	12	9	6	3	0,8			
	480 V - 60 Hz	90 HPL™ 30	m/min	53,5	69,5	99,5	143	220,5	27,5	36,5	52,5	74,5	110	90	66	845 m
			t	6	4,5	3	1,5	0,2	12	9	6	3	0,8			
		6 DVF 6 Optima	m/min	0 → 42 (12 t) 0 → 84 (8 t) 0 → 100 (4 t)									5,5	4		
	400 V - 50 Hz 480 V - 60 Hz	RVF 172 Optima+	tr/min U/min rpm	400 V - 50 Hz : 0 → 0,8 480 V - 60 Hz : 0 → 0,9									2 x 10	2 x 7,5		

	IEC 60204-32	
400 V (+10% -10%) 50 Hz	75 HPL™ : 84 → 54 kVA	
480 V (+6% -10%) 60 Hz	90 HPL™ : 96 → 60 kVA	

	FR	DE	EN	ES	IT	PT	RU
	Appel de flèche	Auslegerüberhöhung	Jib elevation	Elevación de la flecha	Inclinazione braccio	Desvio da lança	подъем стрелы
	Équipements standards	Standardausrüstungen	Standard equipment	Equipamiento de serie	Equipaggiamento standard	Equipamento de série	Стандартное оборудование
	Équipements optionnels	Sonderausrüstungen	Options	Equipamiento opcional	Equipaggiamento in opzione	Equipamento opcional	Дополнительное оборудование (опция)
	Fonction Potain Plus : Courbes de charges Plus	Funktion Potain Plus: Plus-Lastkurven	Potain Plus function: Plus load curves	Función Potain Plus: Diagrama de cargas Plus	Funzione Potain Plus: Curve di carico Plus	Função Potain Plus: Diagrama de cargas Plus	Функция контроля мощности Potain Plus: Диаграммы грузоподъемности Plus
	Hauteurs sous crochet associées aux courbes de charges Plus	Hakenhöhen mit Plus-Lastkurven	Hook heights with Plus load curves	Altura bajo gancho, usando el diagrama de cargas Plus	Altezze sotto gancio con curve di carico Plus	Altura livre, utilizando o diagrama de cargas Plus	Высота под крюком для диаграмм грузоподъемности Plus
	Réactions en service	Reaktionskräfte in Betrieb	Reactions in service	Reacciones en servicio	Reazioni in servizio	Reacções em serviço	Реакция при работе
	Réactions hors service	Reaktionskräfte außer Betrieb	Reactions out of service	Reacciones fuera de servicio	Reazioni fuori servizio	Reacções fora de serviço	Реакция в покое
	Poids total du lest	Ballast-Gesamtgewicht	Total ballast weight	Peso total del lastre	Peso totale della zavorra	Peso total do lastro	Общий вес балласта
	Cadre d'ancrage serré	Fester Verankerungsrahmen	Tightened anchorage frame	Marco de anclaje de apriete	Quadro di ancoraggio stretto	Quadro de amarração apertado	Прикрепленная анкерная рама
	Cadre d'ancrage desserré	Loser Verankerungsrahmen	Loosened anchorage frame	Marco de anclaje de desapriete	Quadro di ancoraggio allentato	Quadro de amarração solto	Отсоединенная анкерная рама
	Poids de flèche	Auslegergewicht	Jib weight	Peso de flecha	Peso del braccio	Peso da lança	вес стрелы
	Camion 13,4 m	Lkw 13,4 m	Lorry 13,4 m	Camión 13,4 m	Camion 13,4 m	Camião 13,4 m	Ррузовой автомобиль 13,4 м
	Conteneur High Cube 40', et/ou Flat Rack 20'	Container High Cube 40', und/oder Flat Rack 20'	Container High Cube 40', and/or Flat Rack 20'	Contenedor High Cube 40', y/o Flat Rack 20'	Container High Cube 40', e/o Flat Rack 20'	Contentor High Cube 40', e/ou Flat Rack 20'	40-футовый контейнер повышенной вместимости High Cube, и/или 20-футовая открытая платформа Flat Rack
	Levage	Heben	Hoisting	Elevación	Sollevamento	Elevação	Подъем
	Distribution	Katzfahren	Trolleying	Distribución	Ditribuzione	Distribuição	Перемещение по стреле
	Orientation	Schwenken	Slewing	Orientación	Rotazione	Rotação	Поворот
	Translation	Kranfahren	Travelling	Traslación	Traslazione	Translação	Перемещение крана
	Puissance requise	Erforderliche Leistung	Required power	Potencia Necesaria	Potenza richiesta	Potência Necessária	Потребляемая мощность
	Fonction Power Control : vitesses treuils adaptées à la puissance disponible	Funktion Power Control: Geschwindigkeiten der Triebwerke werden an die verfügbare Leistung angepasst	Power Control Function: winch speeds adapted to the available power	Función Power Control: marchas de los cabrestantes adaptadas a la potencia disponible	Funzione Power Control: velocità degli argani adattate alla potenza disponibile	Função Power Control: velocidades de guincho adaptadas à potência disponível	Функция контроля мощности Power Control: регулировка скорости лебедок в зависимости от доступной мощности
	Nous consulter	Auf Anfrage	Consult us	Consultarnos	Consultateci	Consultar-nos	Проконсультируйтесь у нас
	Document commercial non contractuel. Pour toute information technique se référer à la notice correspondante.	Unverbindliches Vertriebsdokument. Für technische Informationen, siehe die entsprechenden Anweisungen.	This commercial document is not legally binding. For any technical information, please refer to the corresponding instructions.	Documento comercial no contractual. Para cualquier información técnica, ver la noticia correspondiente.	Documento commerciale non vincolante, per tutte le informazioni tecniche fare riferimento al catalogo istruzioni.	Documento comercial não contratual. Para qualquer informação técnica complementar consultar as respectivas instruções.	Этот коммерческий документ не является юридически обязательным. Для получения технической информации, см. соответствующие инструкции.

