

Duty Cycle Capacities

Boom No. B10:76A
51 980 kg Crane Counterweight
0 kg Carbody Counterweight
360 Degree Rating - Limited Duty

MLC200 SERIES 1



LIFTING CAPACITIES: Lifting capacities for various boom lengths and operating radii are for freely suspended loads and may be based on percent of static tipping or strength of structural components. Capacities must be reduced by applicable deducts.

Weight of bucket is considered part of load. Where no capacity is shown, operation is not intended or approved.

Duty Cycle capacities shown are intended for limited duration applications. Continuous operation at these capacities may reduce component life.

OPERATING CONDITIONS: Machine to operate on a firm, level, and uniformly supporting surface. Refer to Boom Rigging **No. 80149429**, Wire Rope Specifications chart **No. A018-B**, and Counterweight Arrangements chart **No. A004-A**. Crane operator judgment must be used to allow for dynamic load effects of swinging, hoisting or lowering, travel, wind conditions, as well as adverse operating conditions and physical machine depreciation. Refer to the Operator Manual for operating guidelines.

WIND CONDITIONS: Machine may be operated in winds up to 16 m/s provided crane operator judgment is used to allow for wind effect on lifted load and other considerations noted on capacity chart are followed. Wind speed to be measured at boom point elevation. **Operation is not permitted when wind is above 16 m/s.** Park crane with bucket on ground or secured and position boom at 50 degrees. Lower boom onto blocking at ground level when wind is above 22 m/s.

MACHINE TRAVEL: Machine to travel on a firm, level, and uniformly supporting surface. Boom must be within boom angle range shown in capacity chart. Refer to Maximum Allowable Travel Specifications chart **No. A016-A**.



OPERATING RADIUS: Operating radius is horizontal distance from axis of rotation to center of gravity of freely suspended load.



BOOM ANGLE: Boom angle in degrees (°) is angle between horizontal and centerline of boom butt and inserts, and is an indication of operating radius. In all cases, operating radius shall govern capacity.

MACHINE EQUIPMENT: Machine equipped with 8 280 mm crawlers, 1 200 mm treads, 3 124 mm retractable gantry, 8 250 mm live mast, 20 part boom hoist reeving, and boom support straps.

Raising Ability Over End or Side of Crawlers		
Boom Length (m)	Maximum Number of Lower Boom Point Sheaves	Bucket Weight (kg)
20,0 - 41,0	7	3 625

Bucket weight includes the weight of all blocks, hooks, bucket, weight ball, slings and hoist lines beneath boom point sheaves.

Explanation of Symbols

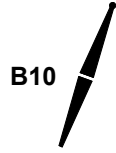

Boom No. B10:76A

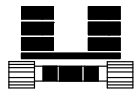

Crane Counterweight
+
Carbody Counterweight



360 Degree Rating



Boom Length

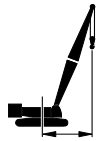

Operating Radius
(see page 1)



Boom Angle
(see page 1)



Lifting Capacities
(see page 1)

MLC200 S-1



51 980 kg
+
0 kg



 **20,0 m**

m	°	kg
9,1	70,7	11 700
9,5	69,6	11 700
10,0	68,0	11 700
10,5	66,4	11 700
11,0	64,8	11 700
12,0	61,6	11 700
13,0	58,2	11 700
14,0	54,7	11 700
15,0	51,0	11 700
16,0	47,1	11 700
18,0	38,3	11 700

 **23,0 m**

m	°	kg
9,1	73,3	11 700
9,5	72,4	11 700
10,0	71,1	11 700
10,5	69,7	11 700
11,0	68,4	11 700
12,0	65,6	11 700
13,0	62,8	11 700
14,0	59,9	11 700
15,0	57,0	11 700
16,0	53,9	11 700
18,0	47,3	11 700
20,0	39,8	11 700
22,0	30,8	11 500

 **26,0 m**

m	°	kg
9,1	75,3	11 700
9,5	74,5	11 700
10,0	73,3	11 700
10,5	72,2	11 700
11,0	71,0	11 700
12,0	68,6	11 700
13,0	66,2	11 700
14,0	63,7	11 700
15,0	61,2	11 700
16,0	58,6	11 700
18,0	53,2	11 700
20,0	47,3	11 700
22,0	40,8	11 500
24,0	33,2	10 400

REFERENCE ONLY

MLC200 S-1



B10

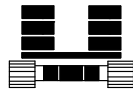

51 980 kg
+
0 lb



360°

29,0 m		
m	°	kg
9,1	76,9	11 700
9,5	76,1	11 700
10,0	75,1	11 700
10,5	74,1	11 700
11,0	73,0	11 700
12,0	70,9	11 700
13,0	68,8	11 700
14,0	66,6	11 700
15,0	64,4	11 700
16,0	62,2	11 700
18,0	57,6	11 700
20,0	52,7	11 700
22,0	47,4	11 500
24,0	41,6	10 200
26,0	35,1	8 700

32,0 m		
m	°	kg
9,1	78,1	11 700
9,5	77,5	11 700
10,0	76,5	11 700
10,5	75,6	11 700
11,0	74,7	11 700
12,0	72,8	11 700
13,0	70,9	11 700
14,0	69,0	11 700
15,0	67,0	11 700
16,0	65,1	11 700
18,0	61,0	11 700
20,0	56,8	11 700
22,0	52,3	11 500
24,0	47,5	10 200
26,0	42,3	8 700
28,0	36,5	7 400
30,0	29,8	6 100

35,0 m		
m	°	kg
9,1	79,2	11 700
9,5	78,5	11 700
10,0	77,7	11 700
10,5	76,9	11 700
11,0	76,0	11 700
12,0	74,3	11 700
13,0	72,6	11 700
14,0	70,9	11 700
15,0	69,1	11 700
16,0	67,3	11 700
18,0	63,7	11 700
20,0	59,9	11 700
22,0	56,0	11 300
24,0	51,9	9 900
26,0	47,6	8 400
28,0	42,8	7 100
30,0	37,7	5 900
32,0	31,7	4 600

REFERENCE ONLY



MLC200 S-1



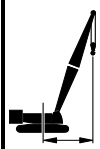

B10

51 980 kg
+
0 kg

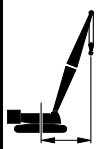

 38,0 m		
 m	 °	 kg
9,1	80,0	11 700
9,5	79,5	11 700
10,0	78,7	11 700
10,5	77,9	11 700
11,0	77,2	11 700
12,0	75,6	11 700
13,0	74,0	11 700
14,0	72,4	11 700
15,0	70,8	11 700
16,0	69,2	11 700
18,0	65,9	11 700
20,0	62,6	11 700
22,0	59,1	11 200
24,0	55,4	9 700
26,0	51,7	8 200
28,0	47,6	6 900
30,0	43,3	5 700
32,0	38,6	4 400

 41,0 m		
 m	 °	 kg
9,1	80,8	11 700
9,5	80,2	11 700
10,0	79,5	11 700
10,5	78,8	11 700
11,0	78,1	11 700
12,0	76,7	11 700
13,0	75,2	11 700
14,0	73,8	11 700
15,0	72,3	11 700
16,0	70,8	11 700
18,0	67,8	11 700
20,0	64,7	11 700
22,0	61,6	10 800
24,0	58,3	9 300
26,0	54,9	7 900
28,0	51,4	6 500
30,0	47,7	5 300
32,0	43,7	4 000

REFERENCE ONLY!