



model 8500

features

- 80 t (85 USt) Lift Capacity
- 282 t-m (2,041 ft-kips) Maximum Load Moment
- 61,0 m (200 ft) Heavy-Lift Boom
- 73,2 m (240 ft) Fixed Jib on Heavy-Lift Boom
- 159 kW (213 HP) engine
- 160 mpm (525 fpm) line speed
- 14 500 kg (32,000 lb) Maximum Line Pull
- 7 700 kg (17,000 lb) Rated Line Pull
- 7 300 kg (16,000 lb) Material Rehandling Clamshell capacity
- Fast, efficient self-assembly and disassembly
- Manitowoc Crane CARE comprehensive support



product guide



contents

Specifications	3
Outline Dimensions	6
Self Assembly	10
Boom Combinations	11
Winch Performance Data	12
Load Chart Notes	13
Range Diagrams and Load Charts	14
Clamshell	19
Crane CARE	20



specifications

3

Upperworks



Engine

Hino J08E-TM Diesel, 6 cylinder, water-cooled diesel, direct fuel injection with turbocharger, 159 kW (213 HP) @ 2000 high-idle RPM. Maximum torque 797 N·m (593 lb·ft) net at 1,600 rpm (SAE J 1349).

One diesel fuel tank, 400 liters (105 gallons) capacity.

Two 12 volt 136 AH capacity batteries, 24 volt system and 60 amp alternator.

All wiring harnesses and connectors are numbered for easier servicing. Machine is equipped with individual fused branch circuits.



Controls

Full-flow hydraulic control system for constant variable pressure to front and rear drums, boom hoist brakes and clutches. Controls respond instantly to the touch, delivering smooth function operation.

Relief valve pressures:

Load hoist, boom hoist

and propel system 315kg/cm² (4,480 psi)

Swing system 280 kg/cm², (980psi)

Control system 80 kg/cm² (1,140 psi)



Hydraulic System

All three variable displacement piston-type pumps are driven by a heavy-duty pump drive. One of these pumps is used in the right propel circuit and hook hoist circuit, and can accommodate an optional third circuit. Another is used in the left propel circuit, boom hoist circuit and hook hoist circuit. The third variable displacement pump is used in the swing circuit. In addition, two gear pumps are used in the control system and auxiliary equipment, and two gear pumps serve the brake cooling system.

Maximum pressure rating 325 kg/cm² (4,640 psi)

Load hoist, boom hoist and propel 2 Piston pumps

Swing 1 Piston pump

Control system and auxiliary 2 Gear pumps

Brake cooling system 2 Gear pumps

Reservoir capacity: 380 liter (100 US gallon).

Cooling: Oil-to-air heat exchanger (plate-fin type).

Filtration: Full-flow and bypass type with replaceable paper element.



Drums

Front and rear drums for load hoist powered by hydraulic variable displacement piston-type motors, driven through planetary reducers. Powered hoisting/lowering and free-fall operation is standard. Drum turn indicators for front and rear drums are also standard.

Brakes: spring set, hydraulically-released, multiple-disc holding brake is mounted inside the hoist motor and is operated through a counter-balance valve. An external ratchet is fitted for locking the drums.

Drums: front and rear 550.2 mm (21.7") P.C.D. X 545.4 mm (21.5"), grooved for 22.2 mm (7/8") wire rope.

Wire rope capacity:

Front drum 265 m (869 ft) working length

Rear drum 210 m (688 ft) working length

Storage length (each drum) 335 m (1,099')

Line speed: Single line on the first drum layer

Hoisting: 120m/min (390 ft/min)

Lowering: 120m/min (390 ft/min)

 **Optional third drum:** same dimensions and specifications as front and rear drums.

Wire rope working length 265m (869')



Swing System

Swing unit: Powered by a hydraulic piston-type motor driving spur gears through planetary reducers, the swing system provides 360° rotation.

Swing brake: A spring-set, hydraulically released multiple-disc brake is internally fitted in swing motor.

Swing lock: 2 Position lock for transportation.

Rotating bed turntable: Single-row ball bearing with an integral internally cut swing gear.

Swing speed: 4.0 rpm



Boom Support System

Single drum powered by a hydraulic axial piston motor through a planetary reducer.

Brake: A spring-set, hydraulically released multiple-disc brake is internally fitted in the boom hoist motor and operated through a counter-balance valve. An external ratchet is fitted for locking the drum.

Drum: Single drum, grooved for 16 mm (5/8") diameter wire rope. Boom Hoist reeving is 12-part line.

specifications

Wire Rope Capacity:

Drum 150 m (492 ft) working length.

4

Line speed: Single line on the first drum layer

Hoisting 70m/min (230 ft/min)

Lowering 70m/min (230 ft/min)



Gantry

This high folding type gantry is fitted with a sheave frame for boom hoist reeving. Hydraulic lift is standard. It provides full up, full down positions with linkage.



Counterweight

QTY.	ITEM	UNIT WEIGHT		TOTAL WEIGHT	
		kg	lb	kg	lb
2	Carbody				
	Each	3 340	7,350	6 680	14,700
Carbody Total		6 680	14,700		
1	Upperworks				
	Counterweight A	12 500	27,560	12 500	27,560
1	Counterweight B	12 400	27,340	12 400	27,340
Upperworks Total		24 900	54,900		
Counterweight TOTAL		31 580	69,600		



Operator's Cab

Totally enclosed, full vision cab fitted with tinted safety glass. A fully adjustable, highbacked seat with arm rests permits operators to set their ideal working position. Side mounted console for auxiliary controls and instruments. An air conditioner, a signal horn, cigarette lighter, windshield wiper and inspection lamp socket are standard features.

Controls

In front of operator are the foot pedals for front, rear and third drum (optional) brakes and foot throttle pedal. At operator's right side are the travel (propel) control levers and the function lock lever. To the operator's right front are the boom hoist control lever, front and rear winch control levers and the free-fall select switches for the front and rear winches and drum turn indicators (front /rear drum). To the operator's left front are the swing control lever and third drum (optional) control lever. To the operator's left are the crawler extend/retract lever and the positive swing lock. The left hand console contains toggle switches for travel (propel) speed, free-fall high/low select, gantry control, crane/clamshell select switch and the anti-two-block/boom overhoist switches. Directly in front of the console are the drum pawl lock for boom, front, rear and third drum (optional) and the engine ignition key. The swing parking brake and signal horn are mounted on the swing control lever.

Gauges

Fuel gauge, engine water temperature gauge, hour meter and tachometer are located on the monitor display.

Warning display

All potential warnings, including battery charge, engine oil pressure, air cleaner, engine oil filter, control main pressure, and hydraulic oil temperature will appear on the monitor display when a fault occurs.

Safety device

Function lock lever, anti-two-block, boom over hoist limit switch, boom angle indicator, signal horn, boom hoist drum lock, front and rear drum lock, swing lock, swing alarm (buzzer and lamps), boom backstops and load moment indicator.

Lowerworks



Carbody

The durable carbody features steel welded construction with extendible axles.



Crawlers

Crawler assemblies can be hydraulically extended for wide-track operation or retracted for transportation. Crawler belt tension adjusted with hydraulic jack and maintained by shims between idler block and frame.

Crawler drive

The independent hydraulic propel drive is built into each crawler side frame. Each drive consists of a hydraulic motor driving a propel sprocket through a planetary gearbox. The hydraulic motor and gearbox are built into the crawler side frame within the shoe width. The track rollers are sealed for maintenance-free operation.

Crawler brakes

Spring set, hydraulically released, multiple disc-type parking brakes are built into each propel drive.

Steering mechanism

The hydraulic propel system provides both skid steering (driving one track only) and counter-rotating steering (driving each track in opposite direction) and differential track speed.

Crawler shoes:

63 shoes per side, 914 mm (36") wide each crawler.

Travel speed:

(High/Low) 1.9/1.2 km/h (1.18/0.75 mph)

Attachments



Boom

Welded lattice construction using tubular, high-tensile steel chords with pin connections between sections. Boom tip is open throat construction. Two idler sheaves and three point sheaves are standard.

Basic boom length 12,2 m (40') consists of the boom butt section 5,8 m (19') and boom top section 6,39 m (21').

Optional boom inserts are available to provide extension capabilities. They also have welded lattice construction with tubular, high-tension steel chords and pin connections on each one of 3,0 m (10'), 6,1 m (20'), 12,2 m (40') inserts.

Maximum total length of boom 61,0 m (200').



Fixed Jib

The optional fixed jib employs welded lattice construction with tubular, high-tension steel chords with pin connections between sections.

Basic jib length 9,14 m (30') consists of Jib butt section 4,57 m (15') and jib top section 4,57 m (15').

Optional jib boom inserts of 3,0 m (10'), 6,1 m (20') are available for extension capabilities up to 18,3 m (60').

Maximum total length of boom and jib 54,9 m (180') + 18,3 m (60') is 76,2 m (250').

Tools and Accessories

A set of tools and accessories are furnished.

Optional Equipment

▶ Optional: Blocks and Hooks each with roller bearing sheaves grooved for 22.2 mm (7/8") diameter wire rope, and roller bearing swivel with hook latch.

▶ 11 t ball hook, 328 kg wedge socket for 22 mm wire rope.
(12 USt ball hook, 722 lb wedge socket for 7/8" wire rope.)

▶ 19 t hook block, 400 kg with one 500 mm Nominal O.D. roller bearing sheave.

▶ 32 t hook block, 500 kg with two 500 mm Nominal O.D. roller bearing sheaves.

▶ 55 t hook block, 700 kg, four 500 mm Nominal O.D. roller bearing sheave.

(60 USt hook block, 2,486 lb, with four 24" Nominal O.D. roller bearing sheaves.)

▶ 80 t hook block, 800 kg, with five 500 mm Nominal O.D. roller bearing sheaves.
(90 USt hook block, 2,892 lb with five 24" Nominal O.D. roller bearing sheaves.)

▶ Optional: Detachable upper boom point with one 561 mm Nominal O. D. roller bearing steel sheave grooved for 22.2 mm (7/8") rope for liftcrane.

Travel kit

Custom color

Working Weight

Approximately 73,800 kg (162,700 lb) including upperworks and lowerworks, full upper counterweights, full carbody counterweights and 12,2 m (40') basic boom.

Ground Pressure

Approximately 77.1 kPa (11.2 psi) with basic boom.

Gradeability

With basic boom: 40%.

outline dimensions

6

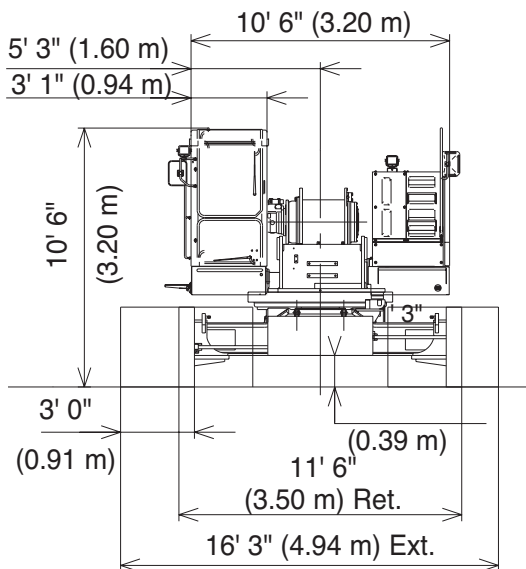
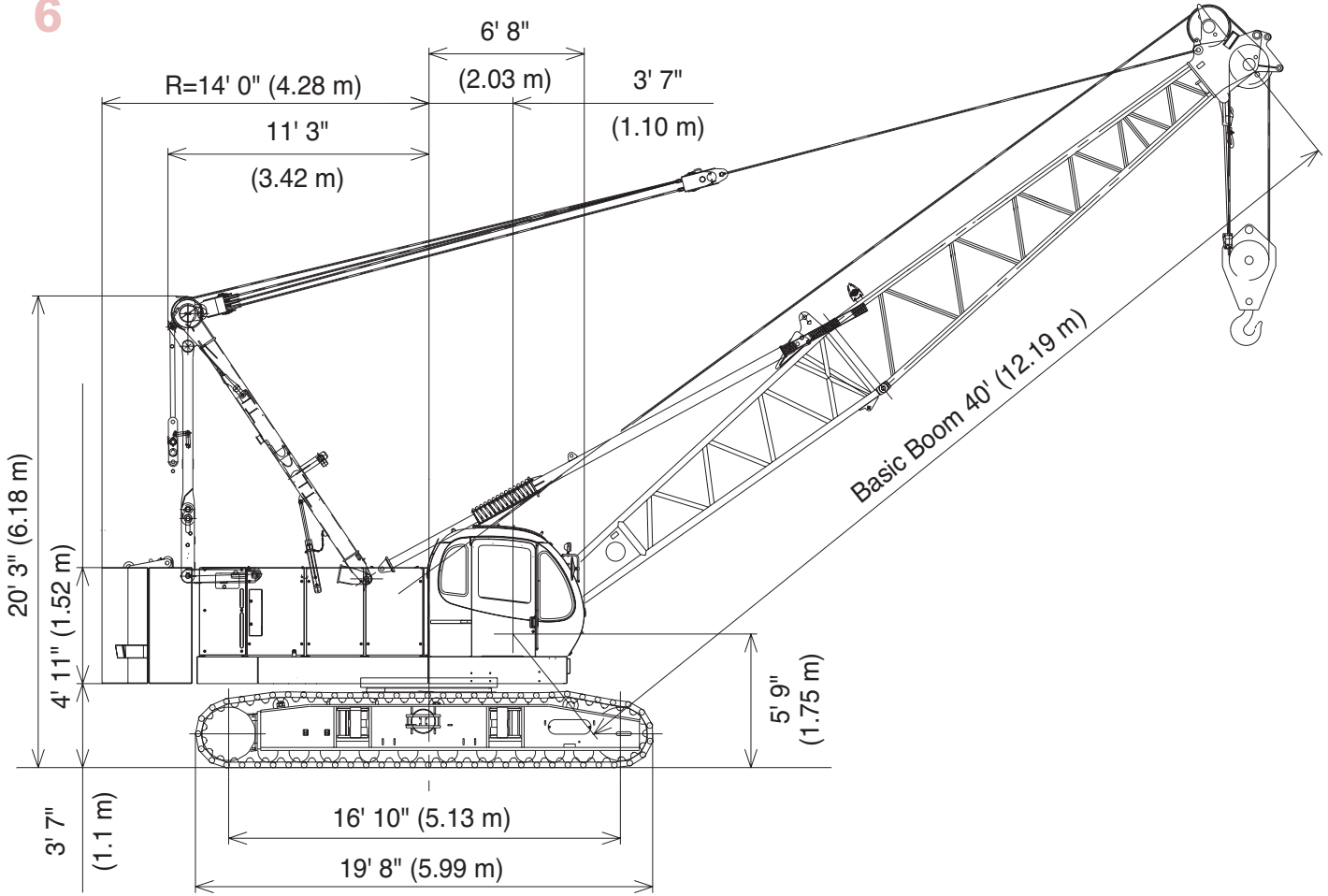

outline dimensions

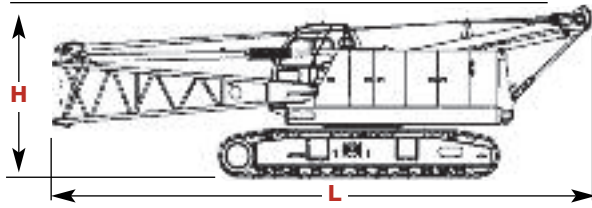

Upperworks x 1

Length	12,16 m	39' 11"
Width	3,50 m	11' 6"
Height	3,45 m	11' 4"
Weight	40 820 kg	89,980 lb

Note: Weight includes base machine, crawler, gantry, maximum hoist and whip lines on drums, boom butt, full hydraulic fluid reservoir, and one third tank of fuel.

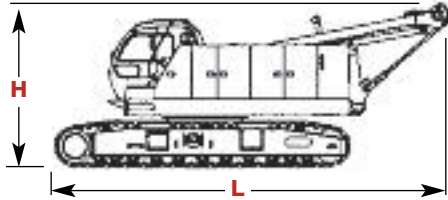

Upperworks x 1

Length	8,27 m	27' 2"
Width	3,50 m	11' 6"
Height	3,45 m	11' 4"
Weight	38 700 kg	85,350 lb

Note: Weight includes base machine, crawler, gantry, maximum hoist and whip lines on drums, full hydraulic fluid reservoir, and one third tank of fuel.

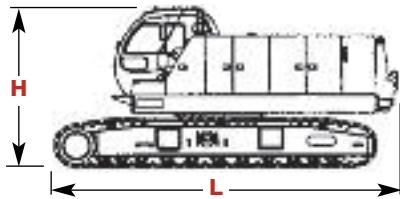

Upperworks x 1

Length	6,55 m	21' 6"
Width	3,50 m	11' 6"
Height	3,20 m	10' 6"
Weight	37 000 kg	81,600 lb

Note: Weight includes base machine, crawler, maximum hoist and whip lines on drums, full hydraulic fluid reservoir, and one third tank of fuel.

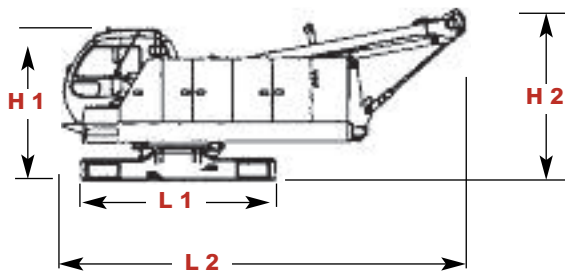

Upperworks x 1

Length 1	3,39 m	11' 1"
Length 2	6,31 m	23' 9"
Width	3,20 m	10' 6"
Height 1	2,81 m	9' 3"
Height 2	3,06 m	10' 1"
Weight	23 800 kg	52,500 lb

Note: Weight includes base machine, gantry, maximum hoist and whip lines on drums, full hydraulic fluid reservoir, and half tank of fuel.

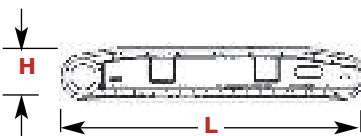

Crawlers x 2

Length	5,99 m	19' 8"
Width	0,91 m	3' 0"
Height	0,98 m	3' 3"
Weight	7 400 kg	16,317 lb

Optional 3rd Drum & Wire Rope x 1

Weight	1 930 kg	4,236 lb
--------	----------	----------

Note: Not illustrated.

Option

outline dimensions

8

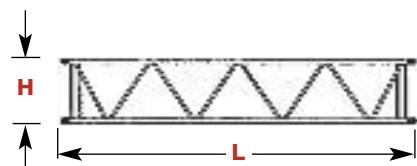
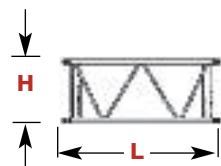
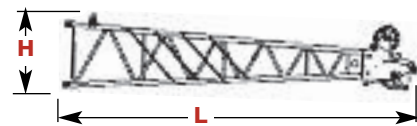
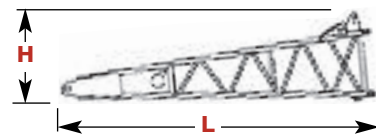
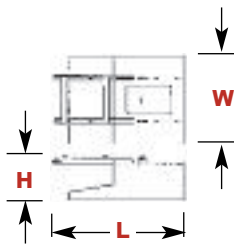
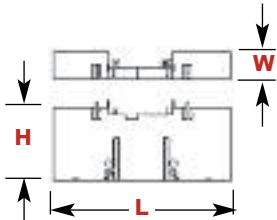
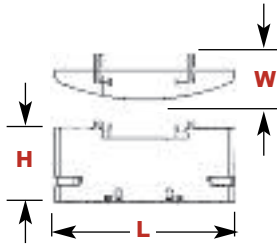

Upper Counterweight A x 1

Length	3,60 m	11' 10"
Width	0,91 m	3' 0"
Height	1,64 m	5' 5"
Weight	12 500 kg	27,563 lb

Upper Counterweight B x 1

Length	3,60 m	11' 10"
Width	0,57 m	1' 10"
Height	1,67 m	5' 6"
Weight	12 400 kg	27,342 lb

Carbody Counterweight x 2

Length	1,72 m	5' 8"
Width	1,16 m	3' 10"
Height	0,58 m	1' 11"
Weight	3 340 kg	7,350 lb

Boom Butt 5,8 m (19') x 1

Length	5,97 m	19' 7"
Width	1,42 m	4' 8"
Height	1,48 m	4' 10"
Weight	1 055 kg	2,326 lb

Boom Top 6,4 m (21') x 1

Length	6,90 m	22' 8"
Width	1,38 m	4' 6"
Height	1,48 m	4' 10"
Weight	1 010 kg	2,227 lb

Option Boom Insert 3,0 m (10') x 1, 2

Length	3,16 m	10' 4"
Width	1,36 m	4' 6"
Height	1,29 m	4' 3"
Weight	270 kg	590 lb

Option Boom Insert 6,1 (20') x 1, 2

Length	6,21 m	20' 5"
Width	1,36 m	4' 6"
Height	1,29 m	4' 3"
Weight	465 kg	1,025 lb

Option

outline dimensions

9

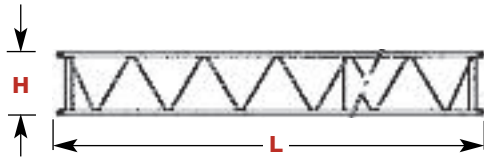

	Boom Insert 12,2 m (40') x 1, 2, 3	
Length	12,31 m	40' 5"
Width	1,36 m	4' 6"
Height	1,29 m	4' 3"
Weight	860 kg	1,896 lb
Weight	A875 kg	1,929 lb

Note: Use one "A" type insert with lug required for any boom combinations that require a 12,2 m (40') insert.

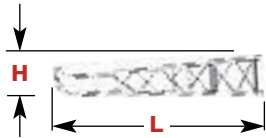

	Fixed Jib Butt x 1	
Length	4,81 m	15' 9"
Width	0,79 m	2' 7"
Height	0,79 m	2' 7"
Weight	200 kg	440 lb

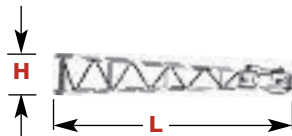

	Fixed Jib Top x1	
Length	4,96 m	16' 3"
Width	0,79 m	2' 7"
Height	0,79 m	2' 7"
Weight	280 kg	617 lb

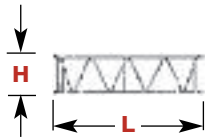

	Fixed Jib Insert 3,0 m (10') x 1	
Length	3,12 m	10' 3"
Width	0,79 m	2' 7"
Height	0,79 m	2' 7"
Weight	100 kg	221 lb



	Fixed Jib Insert 6,1 m (20') x 1	
Length	6,16 m	20' 3"
Width	0,79 m	2' 7"
Height	0,79 m	2' 7"
Weight	180 kg	397 lb

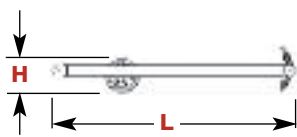

	Fixed Jib Strut x 1	
Length	3,62 m	11' 11"
Width	0,84 m	2' 9"
Height	0,62 m	2' 2"
Weight	250 kg	550 lb

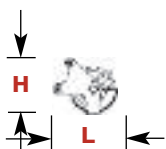

	Upper Sheave x 1	
Length	0,83 m	2' 9"
Width	0,28 m	1' 0"
Height	0,74 m	2' 5"
Weight	145 kg	320 lb

Option

self assembly

10

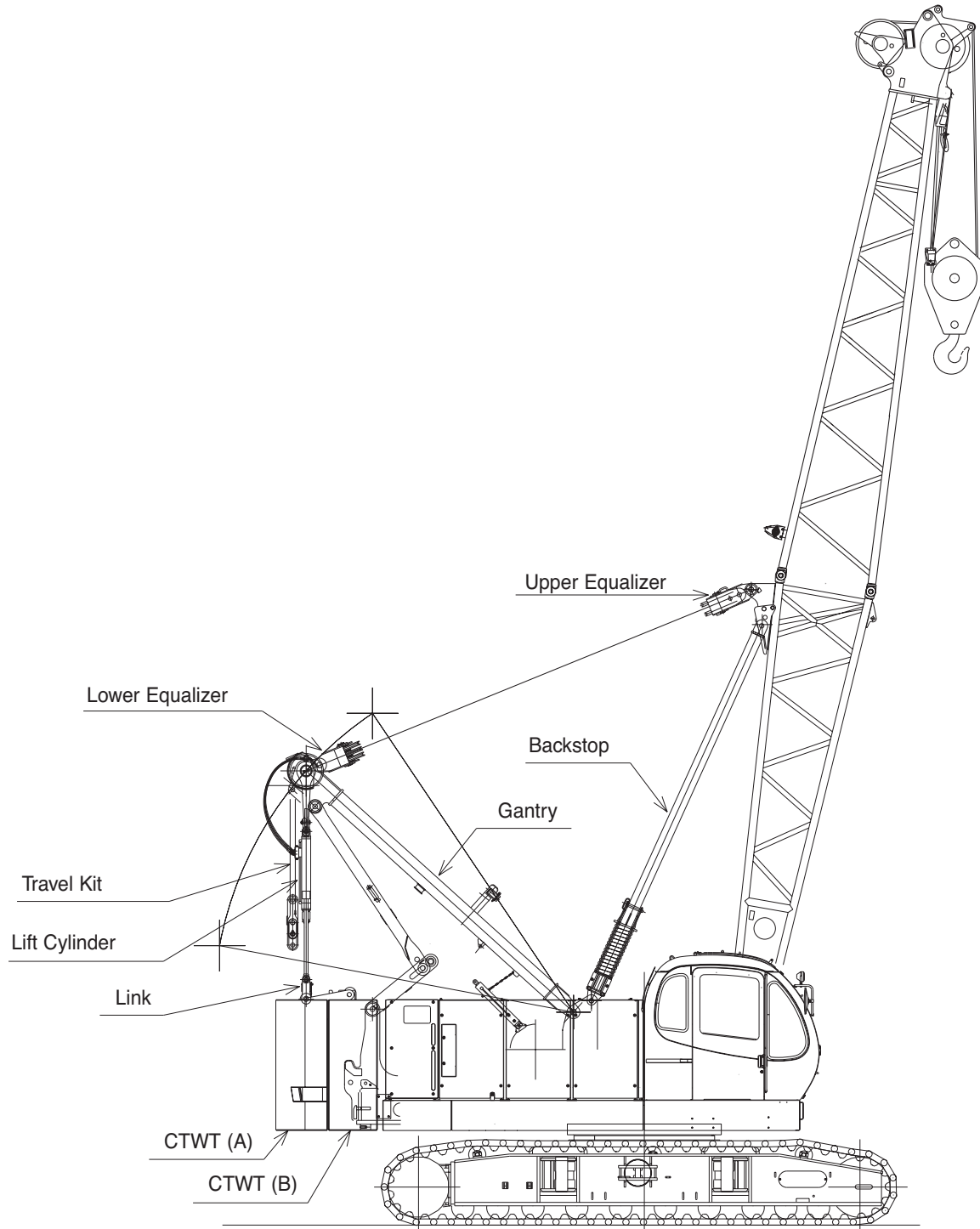

boom combinations

No. 8500 Heavy-Lift Boom Combinations

Boom Length m (ft)	Boom Inserts		
	3,1 m (10 ft)	6,1 m (20 ft)	12,2 m (40 ft)
12,2 (40)	-	-	-
15,2 (50)	1	-	-
18,3 (60)	2	-	-
21,3 (70)	1	1	-
24,4 (80)	2	1	-
27,4 (90)	1	2	-
30,5 (100)	2	2	-
33,5 (110)	1	1	1*
36,6 (120)	2	1	1*
39,6 (130)	1	2	1*
42,7 (140)	2	2	1*
45,7 (150)	1	1	2*
48,8 (160)	2	1	2*
51,8 (170)	1	2	2*
54,9 (180)	2	2	2*
57,9 (190)	1	1	3*
61,0 (200)	2	1	3*

*Note: One 40 ft. (12,20 m) boom insert with lug 40A (12,20 m) is required for crane jib. When no jib is available, a 40 ft (12,20 m) boom can be used instead of 40A (12,20 m).

Fixed Jib Combinations

Jib Length m (ft)	Fixed Jib Inserts	
	3,1m (10 ft)	6,1m (20 ft)
9,1 (30)	-	-
12,2 (40)	1	-
15,2 (50)	-	1
18,3 (60)	1	1

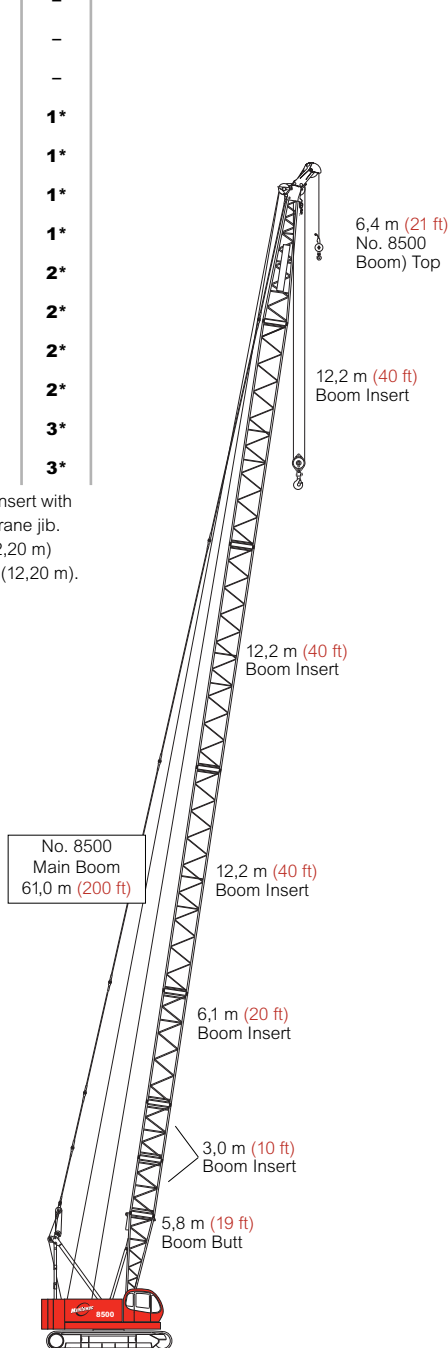

Model 8500 Main Boom
61,0 m (200 ft)

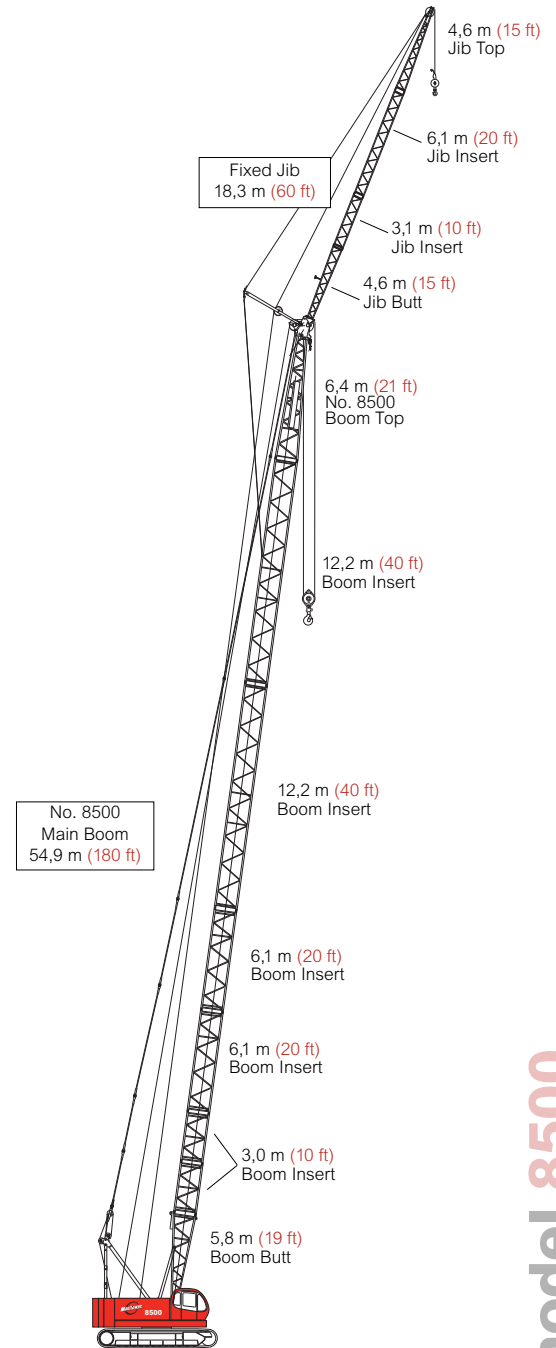

Model 8500 Fixed Jib on Main Boom
73,2 m (240 ft)

winch performance data

12

Line Pull

	Rated line pull	* Maximum line pull
Front Drum	7,700 kg (17,000 lb)	14,500 kg (32,000 lbs)
Rear Drum	7,700 kg (17,000 lb)	14,500kg (32,000 lbs)
Optional 3rd Drum	7,700 kg (17,000 lb)	14,500 kg (32,000 lbs)

* Maximum line pull is not based on wire rope strength.

Wire Rope Specifications

Use	Specs	Diameter mm (inch)	Working Length m (ft)	Breaking Strength kg (lbs)
Front Drum	IWRC C/O 6 X Fi (29)	22,2 (7/8")	265 (869')	37,015 (81,570)
Rear Drum	IWRC C/O 6 X Fi (29)	22,2 (7/8")	210 (688')	37,015 (81,570)
Boom Hoist Drum	IWRC O/O 6 X WS (31)	16,0 (5/8")	150 (492')	18 700 (41,234)
Opt. Third Drum	IWRC C/O 6 X Fi (29)	22,2 (7/8")	265 (869')	37,015 (81,570)

Model 8500 Front and Rear Winch (Opt. Third Winch)

Line Speed m/min (ft/min)							
Layer		1	2	3	4	5	
	Line Pull kg (lbs)						
	0	120 (394)	128 (420)	136 (446)	144 (495)	152 (499)	160 (525)
	2 268 (5,000)	120 (394)	128 (420)	136 (466)	144 (495)	152 (499)	160 (525)
	4 536 (10,000)	108 (353)	108 (353)	108 (353)	108 (353)	108 (353)	108 (353)
	6 804 (15,000)	72 (235)	72 (235)	72 (235)	72 (235)	72 (235)	72 (235)
Rated Line Pull	7 711 (17,000)	63 (208)	63 (208)	63 (208)	63 (208)	63 (208)	63 (208)
	9 072 (20,000)	54 (176)	54 (176)	54 (176)	54 (176)	55 (179)	56 (182)
	11 340 (25,000)	43 (141)	44 (146)	45 (148)	45 (149)	45 (149)	
	13 608 (30,000)	38 (123)					

Note:

Line speeds and line pull based on single line.

Line pulls are not based on wire rope strength

load chart notes

13

- Rated loads included in the charts are the maximum allowable freely suspended loads at a given boom length, boom angle and load radius, and have been determined for the machine standing level on firm supporting surface under ideal operating conditions. The user must limit or de-rate rated loads to allow for adverse conditions (such as soft or uneven ground, out-of-level conditions, wind, side loads, pendulum action, jerking or sudden stopping of loads, inexperience of personnel, multiple machine lifts, and traveling with a load).
- Capacities do not exceed 75% of minimum tipping loads. Capacities based on factors other than machine stability such as structural competence are shown by asterisk * in the charts.
- The machine must be reeved and set-up as stated in the operation manual and all the instruction manuals if these manuals are missing, obtain replacements. Boom backstops are required for all boom lengths. Gantry must be fully raised position for all operations. Crawlers must be fully extended and be locked in position. The crane must be leveled to within 1% on a firm supporting surface.
- Do not attempt to lift where no radius or load is listed as crane may tip or collapse.
- Attempting to lift more than rated loads may cause machine to tip or collapse. Do not tip machine to determine capacity.
- Weight of hooks, hook blocks, slings and other lifting devices are a part of the total load. Their total weight must be subtracted from the rated load to obtain the weight that can be lifted.
- When lifting over boom point with jib or upper boom point installed, rated loads for the boom must be deducted as shown below.

Jib length	Upper Boom Point	9,1 (30')	12,2 (40')	15,2' (50')	18,3 (60')
Deduct kg (lbs)	200 (320)	1 100 (2,400)	1 500 (3,200)	2 000 (4,200)	2 400 (5,200)

- The total load that can be lifted by the jib is limited by rated jib loads.
- Boom lengths for jib mounting are 24.4 m (80 ft) to 54.9 m (180 ft)
- The total load that can be lifted by the upper boom point is: the rated load for the boom (without upper boom point installed) minus 200 kg (320 lbs); however, the upper boom point rated load should not exceed 7700 kg (17,000 lbs).

- An upper boom point cannot be used on a 61 m (200 ft) boom length.
- The boom should be erected over the front of the crawlers, not laterally. When erecting and lowering the boom with a length of 54.9 m (180 ft) with jib, blocking must be placed at the end of the crawlers. See operator's manual for details.
- Least stable position is over the side.
- Maximum hoist load for number of reeving parts of line for hoist rope.

Maximum Load for Main Boom

No. of Parts of Line	1	2	3	4	5
Maximum Loads kg (lbs)	7 700 (17,000)	15 400 (34,000)	23 100 (51,000)	30 800 (64,000)	38 500 (85,000)

No. of Parts of Line	6	7	8	9	10
Maximum Loads kg (lbs)	46 200 (102,000)	53 900 (119,000)	61 600 (136,000)	69 300 (153,000)	80 000 (170,000)

Maximum Load for Fixed Jib

No. of Parts of Line	1	2
Maximum Loads kg (lbs)	7 700 (17,000)	10 800 (24,000)

Maximum Load for Upper Boom Point

No. of Parts of Line	1
Maximum Loads kg (lbs)	7 700 (17,000)

- Lifting capacities listed apply only to the machine as originally manufactured and designed for Manitowoc Cranes, Inc. Modifications to this machine or use of equipment other than that specified can reduce operating capacity.
- Designed and rated to comply with ANSI Code B30.5.

Operation of this equipment in excess of rated loads or disregard of instruction voids the warranty.

heavy-lift boom range diagram

No. 8500 Main Boom

14

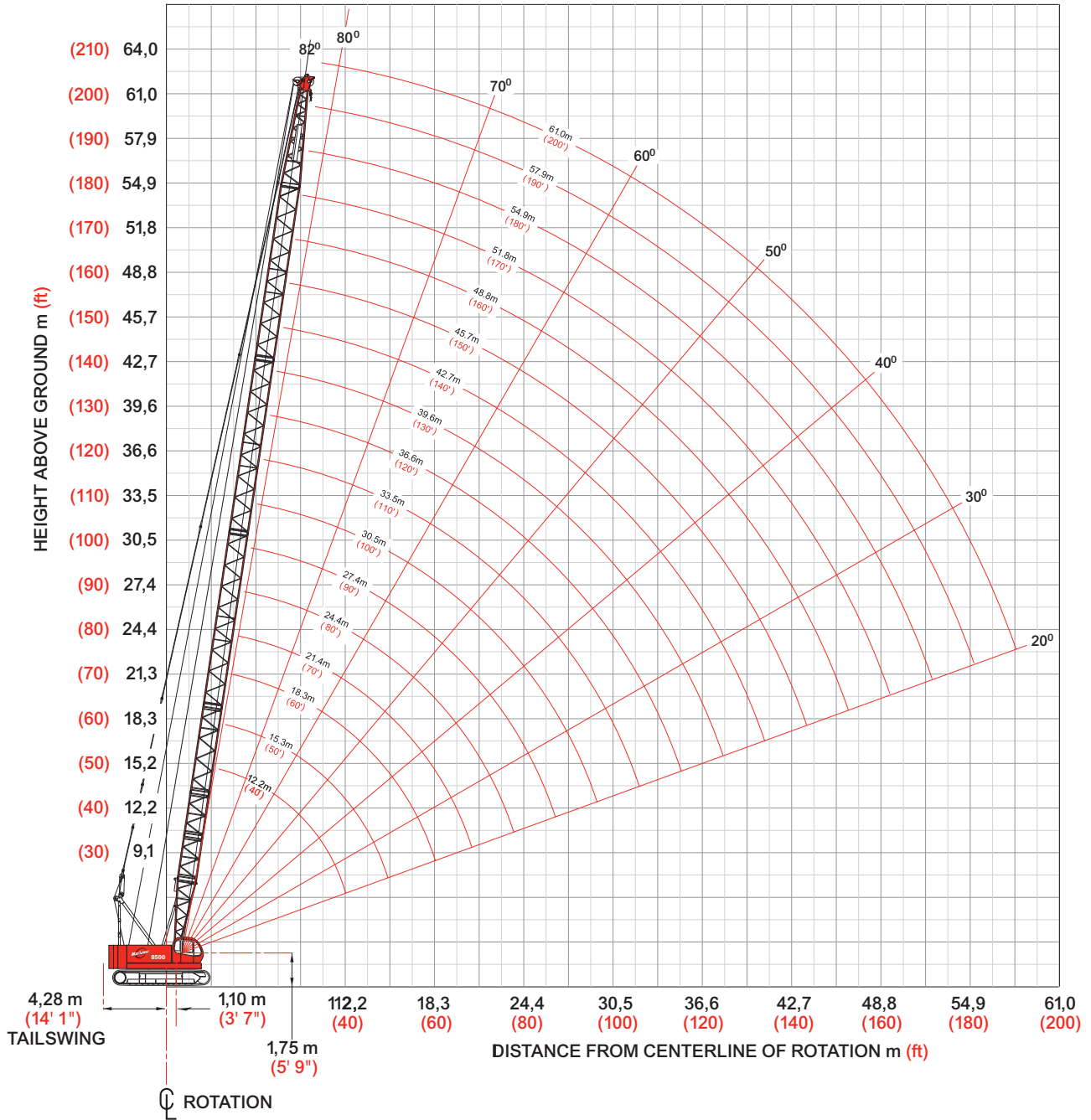

heavy-lift load charts

15

Model 8500 Liftcrane Boom Capacities No. 8500 Main Boom

24 900 kg (54,900 lb) Crane Counterweight, 6 700 kg (14,700 lb) Carbody Counterweight Crawler
Extended

360° Rating

kg (lb) x 1 000

Boom m (ft)	12,2 (40)	15,2 (50)	18,3 (60)	24,4 (80)	30,5 (100)	36,6 (120)	42,7 (140)	48,8 (160)	54,9 (180)	57,9 (190)	61,0 (200)
Radius											
3,0 (10)	80,0 (170.0)										
3,5 (12)	76,3 (166.6)	— (166.4)									
4,0 (14)	69,5 (144.2)	69,5 (144.0)	69,9 (143.8)								
4,5 (16)	61,8 (127.1)	61,7 (126.9)	62,0 (126.7)	— (126.3)							
5,5 (18)	51,2 (113.4)	51,3 (113.2)	51,1 (113.0)	50,9 (112.6)							
6,0 (20)	45,4 (97.5)	45,3 (97.4)	45,2 (97.1)	45,1 (96.9)	44,6 (96.8)						
7,0 (24)	35,9 (74.0)	35,8 (73.8)	35,7 (73.6)	35,6 (73.3)	35,3 (73.1)	34,9 (73.0)	— (61.7)				
8,0 (28)	29,3 (59.5)	29,4 (59.2)	29,3 (58.9)	29,2 (58.7)	29,1 (58.4)	28,9 (58.3)	27,4 (57.9)	— (44.0)			
10,0 (34)	21,7 (45.7)	21,6 (45.5)	21,5 (45.2)	21,3 (44.8)	21,2 (44.5)	21,0 (44.3)	21,0 (44.0)	19,2 (42.1)	14,9 (32.6)	13,3 (28.8)	— (25.7)
12,0 (40)	16,4 (34.8)	17,0 (36.8)	16,8 (36.4)	16,7 (36.0)	16,5 (35.7)	16,4 (35.4)	16,3 (35.1)	16,2 (34.9)	14,1 (31.0)	12,5 (27.5)	11,1 (24.4)
14,0 (45)		13,9 (31.6)	13,8 (31.2)	13,6 (30.8)	13,4 (30.5)	13,2 (30.2)	13,2 (29.9)	13,1 (29.7)	12,9 (29.2)	11,9 (26.4)	10,5 (23.3)
16,0 (55)			11,6 (24.2)	11,4 (23.7)	11,2 (23.3)	11,1 (23.0)	11,0 (22.6)	10,9 (22.4)	10,7 (22.0)	10,7 (22.1)	9,9 (21.3)
22,0 (75)				7,5 (15.9)	7,3 (15.4)	7,2 (15.0)	7,0 (14.6)	6,9 (14.3)	6,7 (13.9)	6,7 (13.9)	6,6 (13.7)
28,0 (95)					5,3 (11.2)	5,1 (10.7)	4,9 (10.2)	4,7 (10.0)	4,5 (9.5)	4,5 (9.5)	4,4 (9.3)
32,0 (105)						4,2 (9.2)	3,9 (8.7)	3,8 (8.5)	3,6 (8.0)	3,6 (8.0)	3,5 (7.8)
34,0 (115)						3,9 (8.1)	3,6 (7.6)	3,4 (7.2)	3,2 (6.7)	3,2 (6.8)	3,1 (6.5)
38,0 (125)							3,0 (6.6)	2,8 (6.2)	2,6 (5.7)	2,6 (5.7)	2,4 (5.4)
40,0 (135)							2,8 (5.9)	2,6 (5.4)	2,3 (4.7)	2,3 (4.8)	2,2 (4.5)
44,0 (145)								2,1 (4.7)	1,8 (4.0)	1,8 (4.0)	1,7 (3.7)
46,0 (155)									1,6 (3.3)	1,6 (3.3)	1,4 (3.0)
52,0 (170)									1,1 (2.6)	— (2.5)	

Meets ANSI B30.5 Requirements - Capacities do not exceed 75% of static tipping load.
NOTICE: This capacity chart is for reference only and must not be used for lifting purposes.

fixed jib range diagram

No. 8500 Fixed Jib on Main Boom

16

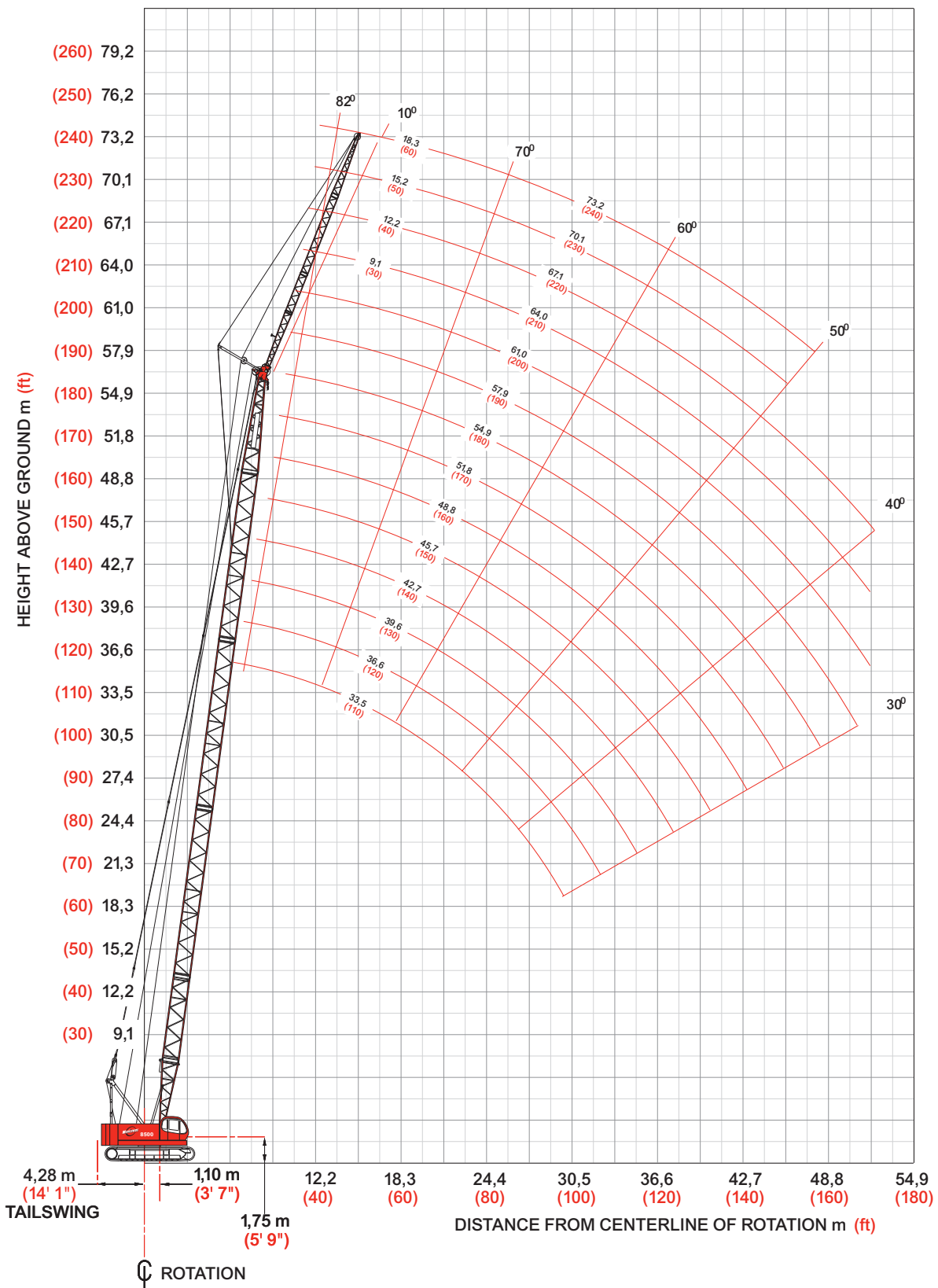

fixed jib load charts

17

Model 8500 Liftcrane Jib Capacities No. 8500 Fixed Jib on Main Boom

24 900 kg (54,900 lb) Crane Counterweight, 6 700 kg (14,700 lb) Carbody Counterweight Crawler Extended

360° Rating

kg (lb) x 1 000

		10° Offset					30° Offset					
		24,4	30,5	39,6	48,8	54,9	Boom	24,4	30,5	39,6	48,8	54,9
		m (ft)	(80)	(100)	(130)	(160)	m (ft)	(80)	(100)	(130)	(160)	(180)
Jib 9,1 m (30 ft)	Radius											
	10,0 (30)	10,8 (24,0)					10,0 (30)					
	12,0 (40)	10,8 (24,0)	10,8 (24,0)	10,8 (24,0)			12,0 (40)	9,0 (19,7)				
	14,0 (50)	10,8 (24,0)	10,8 (24,0)	10,8 (24,0)	10,8 (24,0)	— (19,7)	14,0 (50)	8,3 (17,6)	8,7 (18,5)	— (19,6)		
	18,0 (60)	9,8 (21,3)	9,6 (20,8)	9,4 (20,3)	9,1 (19,7)	8,5 (18,7)	18,0 (60)	7,3 (15,9)	7,7 (16,9)	8,2 (18,0)	8,6 (18,9)	8,4 (18,5)
	24,0 (80)	6,7 (14,4)	6,4 (13,9)	6,2 (13,3)	5,9 (12,7)	5,7 (12,3)	24,0 (80)	6,2 (13,7)	6,5 (14,3)	6,4 (13,7)	6,1 (13,2)	6,0 (12,9)
	30,0 (100)	4,9 (10,6)	4,6 (10,0)	4,3 (9,4)	4,1 (8,8)	3,9 (8,3)	30,0 (100)		5,0 (—)	4,5 (9,7)	4,2 (9,1)	4,1 (8,7)
	36,0 (120)		3,6 (—)	3,2 (6,9)	2,9 (6,2)	2,7 (5,8)	36,0 (120)				3,0 (6,5)	2,8 (6,1)
	42,0 (140)			2,4 (5,2)	2,0 (4,4)	1,8 (3,7)	42,0 (140)					1,9 (4,0)
	44,0 (150)			2,3 (—)	1,8 (3,6)	1,5 (2,9)	44,0 (150)					1,6 (—)
	48,0 (160)				1,4 (2,9)	1,1 (—)	48,0 (160)					
	52,0 (170)				1,1 (—)		52,0 (170)					
Jib 12,2 m (40 ft)	Radius											
	10,0 (30)	10,8 (—)	10,8 (—)				10,0 (30)					
	12,0 (40)	10,8 (24,0)	10,8 (24,0)	10,8 (—)			12,0 (40)	6,9 (—)				
	14,0 (50)	10,7 (22,1)	10,8 (24,0)	10,8 (24,0)	10,3 (22,8)		14,0 (50)	6,8 (14,4)	6,8 (15,1)			
	18,0 (60)	8,6 (18,8)	9,6 (20,9)	9,5 (20,5)	9,2 (20,3)	8,1 (17,8)	18,0 (60)	5,9 (12,9)	6,2 (13,6)	6,6 (14,5)	6,8 (15,1)	
	24,0 (80)	6,6 (14,5)	6,5 (14,1)	6,2 (13,5)	6,0 (12,9)	5,8 (12,5)	24,0 (80)	5,0 (10,9)	5,3 (11,6)	5,7 (12,5)	6,0 (13,2)	6,2 (13,5)
	30,0 (100)	4,9 (10,7)	4,7 (10,2)	4,4 (9,5)	4,1 (8,9)	4,0 (8,5)	30,0 (100)		4,7 (10,3)	4,7 (10,0)	4,5 (9,6)	4,3 (9,3)
	36,0 (120)		3,5 (7,6)	3,2 (7,0)	2,9 (6,4)	2,8 (5,9)	36,0 (120)			3,4 (7,4)	3,2 (6,9)	3,0 (6,5)
	42,0 (140)			2,4 (5,2)	2,1 (4,5)	1,8 (3,9)	42,0 (140)				2,3 (5,0)	2,1 (4,5)
	44,0 (150)			2,2 (4,6)	1,9 (3,7)	1,6 (3,1)	44,0 (150)				2,2 (—)	1,8 (3,6)
	48,0 (160)				1,4 (3,0)	1,2 (—)	48,0 (160)					
	52,0 (170)				1,2 (—)		52,0 (170)					

Meets ANSI B30.5 Requirements - Capacities do not exceed 75% of static tipping load.
NOTICE: This capacity chart is for reference only and must not be used for lifting purposes.

fixed jib load charts

18

Model 8500 Liftcrane Jib Capacities No. 8500 Fixed Jib on Main Boom

24 900 kg (54,900 lb) Crane Counterweight, 6 700 kg (14,700 lb) Carbody Counterweight Crawler Extended

360° Rating

kg (lb) x 1 000

		10' Offset					30' Offset					
		24,4	30,5	39,6	48,8	54,9	Boom	24,4	30,5	39,6	48,8	54,9
		(80)	(100)	(130)	(160)	(190)	m (ft)	(80)	(100)	(130)	(160)	(190)
Jib 15,2 m (50 ft)	Radius											
	10,0 (30)	9,0 (20.0)					10,0 (30)					
	12,0 (40)	9,0 (20.0)	9,0 (20.0)	9,0 (—)			12,0 (40)					
	14,0 (50)	8,9 (18.5)	9,0 (20.0)	9,0 (20.0)			14,0 (50)					
	18,0 (60)	7,2 (15.6)	7,9 (17.2)	8,8 (19.3)	8,7 (19.2)	7,4 (17.0)	18,0 (60)	4,8 (10.4)	5,0 (10.9)	5,2 (11.4)	5,1 (—)	
	24,0 (80)	5,5 (12.0)	6,1 (13.3)	6,3 (13.6)	6,1 (13.1)	5,9 (12.7)	24,0 (80)	4,0 (8.7)	4,2 (9.2)	4,5 (9.8)	4,7 (10.3)	4,8 (10.6)
	30,0 (100)	4,4 (9.7)	4,7 (10.3)	4,5 (9.7)	4,2 (9.1)	4,0 (8.7)	30,0 (100)	3,4 (7.6)	3,7 (8.0)	3,9 (8.7)	4,2 (9.2)	4,3 (9.5)
	36,0 (120)	3,9 (8.6)	3,6 (7.7)	3,3 (7.1)	3,0 (6.5)	2,8 (6.0)	36,0 (120)			3,5 (7.6)	3,3 (7.1)	3,1 (6.8)
	42,0 (140)		2,9 (—)	2,5 (5.7)	2,0 (4.6)	1,9 (4.0)	42,0 (140)				2,4 (5.2)	2,2 (4.8)
	44,0 (150)			2,2 (4.6)	1,8 (3.1)	1,6 (3.2)	44,0 (150)				2,2 (—)	2,0 (3.9)
	48,0 (160)			1,9 (4.0)	1,3 (—)	1,2 (—)	48,0 (160)					1,5 (3.1)
	52,0 (170)				1,2 (—)		52,0 (170)					

		24,4	30,5	39,6	48,8	54,9	Boom	24,4	30,5	39,6	48,8	54,9
		(80)	(100)	(130)	(160)	(190)	m (ft)	(80)	(100)	(130)	(160)	(190)
Jib 18,3 m (60 ft)	Radius											
	10,0 (30)						10,0 (30)					
	12,0 (40)	8,1 (18.0)	8,1 (—)				12,0 (40)					
	14,0 (50)	8,0 (16.3)	8,1 (17.6)	8,1 (18.0)			14,0 (50)					
	18,0 (60)	6,3 (13.7)	6,9 (15.0)	7,6 (16.7)	8,0 (17.8)	6,8 (15.0)	18,0 (60)	4,0 (8.9)	3,9 (—)			
	24,0 (80)	4,8 (10.4)	5,3 (11.5)	6,0 (13.0)	6,1 (13.2)	5,9 (12.8)	24,0 (80)	3,3 (7.3)	3,6 (7.7)	3,7 (8.1)	3,9 (8.5)	3,9 (8.7)
	30,0 (100)	3,8 (8.3)	4,3 (9.3)	4,5 (9.7)	4,2 (9.1)	4,1 (8.7)	30,0 (100)	2,8 (6.2)	3,0 (6.6)	3,2 (7.1)	3,4 (7.5)	3,5 (7.7)
	36,0 (120)	3,2 (7.0)	3,6 (7.8)	3,3 (7.1)	3,0 (6.5)	2,8 (6.1)	36,0 (120)		2,7 (5.9)	2,9 (6.3)	3,1 (6.7)	3,2 (7.0)
	42,0 (140)		2,8 (6.0)	2,5 (5.4)	2,2 (4.7)	1,9 (4.1)	42,0 (140)			2,6 (5.8)	2,5 (5.3)	2,3 (5.0)
	44,0 (150)		2,6 (—)	2,3 (4.7)	1,9 (3.9)	1,7 (3.3)	44,0 (150)				2,2 (4.5)	2,1 (4.1)
	48,0 (160)			1,9 (4.0)	1,5 (3.1)	1,2 (2.5)	48,0 (160)				1,8 (3.8)	1,6 (3.3)
	52,0 (170)				1,1 (2.5)		52,0 (170)					— (2.6)

model 8500



Meets ANSI B30.5 Requirements - Capacities do not exceed 75% of static tipping load.
NOTICE: This capacity chart is for reference only and must not be used for lifting purposes.

Boom:

Welded lattice construction using tubular, high-tensile steel chords with pin connections between sections.
 Basic boom length: 12,2 m (40 ft)
 Max. boom length: 21,3 m (70 ft)
 Limit on clamshell bucket weight: 2 100 kg (4,600 lb)

Boom Component Chart

Boom length ft (m)	Boom arrangement
12,2 (40)	Base-Tip
15,2 (50)	Base-A-Tip
18,3 (60)	Base-A-A-Tip, Base-B-Tip
21,3 (70)	Base-A-B-Tip

Base = 6,1 m (20 ft)
 Insert: A = 3,1 m (10 ft)
 B = 6,1 m (20 ft)
 Tip = 6,1 m (20 ft)

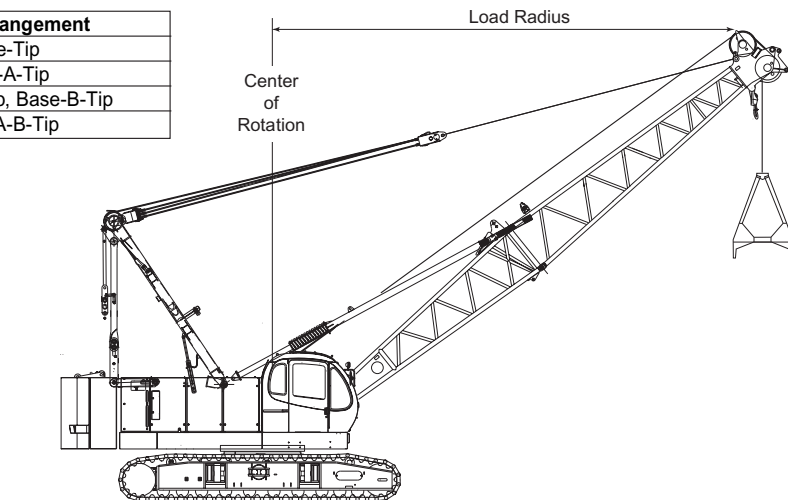

1. Figures represent maximum allowable capacity, and assume level, ground and ideal working conditions.
2. Capacities are calculated at 66% of the minimum tipping loads.
3. Capacities are maximum recommended by PCSA Standard #4. Allowances must be made by the user for such unfavorable conditions as a soft or uneven supporting surface, rapid cycle operations, or bucket suction.
4. The combined weight of the bucket and load must not exceed these capacities.
5. Boom length for clamshell operation should not exceed 21,3 m (70 ft).

Clamshell Capacities

12 500 kg (27,560 lb) Counterweight

kg (lb) x 1 000

Boom m (ft)	12,2 (40)	15,2 (50)	18,3 (60)	21,3 (70)
Radius				
6,7 (22)	7,3 (16.0)			
7,9 (26)	7,3 (16.0)	7,3 (16.0)		
9,1 (30)	7,3 (16.0)	7,3 (16.0)	7,3 (16.0)	
10,9 (36)	7,3 (16.0)	7,3 (16.0)	7,3 (16.0)	7,3 (16.0)
12,2 (40)	7,3 (16.0)	7,3 (16.0)	7,3 (16.0)	7,3 (16.0)
14,0 (46)		7,3 (16.0)	7,3 (16.0)	7,3 (16.0)
15,2 (50)			6,6 (14.5)	6,5 (14.3)
17,1 (56)			5,6 (12.3)	5,6 (12.3)
18,7 (60)				5,1 (11.2)
20,1 (66)				4,4 (9.7)

Manitowoc Crane CARE

20

Crane CARE is Manitowoc's comprehensive service and support program. It includes classroom and on-site training, prompt parts availability, expert field service, technical support and documentation — for every one of the more than 7,000 Manitowoc cranes currently in use throughout the world.

That's commitment you won't find anywhere else.

That's **Crane CARE**.

Service Training

Manitowoc specialists work with you in our training center and in the field to make sure you know how to get maximum performance, reliability and life from your cranes.

Manitowoc Cranes Technical Training Center provides valuable multi-level training, which is available for all models and attachments, in the following format:

- **Basic** – Provides technicians with the basic skills required in our Level I and II classes covering hydraulic and electrical theory and schematics, pump, motor, control, and LMI operation, and the use of meters and gauges.
- **Level 1** – This model-specific class covers theory and offers hands-on training and trouble shooting for all crane systems.
- **Level 2** – This model-specific class provides in depth coverage of all crane systems and components, and advanced troubleshooting of simulated faults. (Requires Level 1.)
- **Level 3/Master** – Covering all EPIC models and the 4100W, this class stresses high level system knowledge and trouble shooting of simulated faults. (Requires Level 2.)

Parts Availability

Genuine Manitowoc replacement parts are accessible through your distributor 24 hours a day, 7 days a week, 365 days a year.

Service Interval Kits

Provides all the parts required by Manitowoc's Preventative Maintenance Checklist.

Hydraulic Filter Kit

Consists of the following:

- Filter Element - Hydraulic in Tank (4)

Cummins Model QSZ15-C600 Diesel

– Service Interval Kits

200 Hour Kit

Consists of the following:

Engine

- Filter Oil (1)
- Filter Water (1)
- Filter Fuel (1)

1,000 Hour Kit

Consists of the following:

Engine

- Filter Air Cleaner - Primary (1)
- Filter Oil (1)
- Filter Water (14)
- Filter Fuel (1)

Hydraulic

- Filter Element - Hydraulic in Tank (4)
- Element - Hydraulic Tank Breather (1)

2,000 Hour Kit

Consists of the following:

Engine

- Filter, Air Cleaner - Primary (1)
- Filter, Air Cleaner - Safety (1)
- Filter, Oil (1)
- Filter, Water (1)
- Filter, Fuel (1)
- Ether, (Bottle) (1)
- Sensor, Coolant Level (10)
- Belt, Fan (1)
- Belt, Alternator (set of two) (1)
- Filter, Element (1)

Hydraulic

- Filter Element - No substitutions allowed
- Filter - Hydraulic In-Tank Suction (4)

Kit, Engine Coolant Additive (SCA) Test (1)

Kit, Seal (for hydraulic in tank filter) (1)

Seal, Radial (for air cleaner) (1)

Hydraulic Test Kit

Protect your investment by demanding Genuine Manitowoc Parts Service Kits. The Hydraulic Service Kit consist of the following:

- All hydraulic fittings to access all pressures and flows.
- Hydraulic flow meters and pressure gauges to record hydraulic data.
- Electrical "Break out" harnesses to access voltages on all electrical circuits on all machines.
- Fluke Digital volt ohm meter, as used in all Manitowoc service literature.

Manitowoc Crane CARE

Hydraulic Test Kit with case

The above kit plus a custom heavy-duty carrying case.

U.S. Standard Tools Kit

All standard tools needed to properly maintain and service your crane. (Does not include torque wrench.)

Field Service

Factory-trained service experts are always ready to help maintain your crane's peak performance.

For a worldwide listing of dealer locations, please consult our website at: www.manitowoccranegroup.com

Technical Support

Manitowoc's dealer network and factory personnel are available 24 hours a day, 7 days a week, 365 days a year to answer your technical questions and more, with the help of computerized programs that simplify crane selection, lift planning, and ground-bearing calculations.

For a worldwide listing of dealer locations, please consult our website at: www.manitowoccranegroup.com

Technical Documentation

Manitowoc has the industry's most extensive documentation, and the easiest to understand, available in major languages and formats that include print, disk and videotape.

Additional copies available through your Authorized Manitowoc Distributor.

- Crane Operator's Manual
- Crane Parts Manual
- Crane Capacity Manual
- Crane Vendor Manual
- Service Manual (EPIC)
- Luffing Jib Operator's/Parts Manual
- Capacity Chart Manual - Attachments

CD rom versions of the Operator's and Parts Manuals are shipped with each crane.

Also available are the following CDs:

- Crane CARE Owner CD –
- Ground Bearing Pressure Estimator CD
- Crane Selection and Planning Software (CompuCRANE®)
- EPIC® Crane Library CD consisting of capacity charts, range diagrams, wire rope specifications, travel specifications, crane weights, counterweight arrangements, luffing jib raising procedures, operating range diagrams, drum and lagging charts, boom rigging drawings, jib rigging drawings, outline dimensions and wind condition charts.

Available from your Authorized Manitowoc Cranes Distributor, these VHS videos are available in NTSC, PAL and SECAM formats.

- Your Capacity Chart Video
- Respect the Limits Video
- Crane Safety Video
- Boom Inspection/Repair Video

Crane CARE Package

Manitowoc has assembled all of the available literature, CD's and videos listed above plus several Manitowoc premiums into one complete Crane CARE Package.



21



Regional Headquarters

Americas

Manitowoc, Wisconsin, USA

Tel: +1 920 684 6621

Fax: +1 920 683 6278

Shady Grove, Pennsylvania, USA

Tel: +1 717 597 8121

Fax: +1 717 597 4062

Regional Offices

Americas

Brazil

Alphaville

Tel: +55 11 4688 2716

Fax: +55 11 4191 1471

Mexico

Monterrey

Tel: +52 81 8124 0128

Fax: +52 81 8124 0129

Europe, Middle East, Africa

Algeria

Hydra

Tel: +21 3 21 48 1173

Fax: +21 3 21 48 1454

Czech Republic

Netvorice

Tel: +420 317 78 9313

Fax: +420 317 78 9314

France

Baudemont

Tel: +33 385 28 2589

Fax: +33 385 28 0430

Cergy

Tel: +33 130 31 3150

Fax: +33 130 38 6085

Decines

Tel: +33 472 81 5000

Fax: +33 472 81 5010

Germany

Langenfeld

Tel: +49 21 73 8909-0

Fax: +49 21 73 8909 30

Hungary

Budapest

Tel: +36 13 39 8622

Fax: +36 13 39 8622

Italy

Parabiago

Tel: +390 331 49 3311

Fax: +390 331 49 3330

Europe, Middle East, Africa

Ecully, France

Tel: +33 472 18 2020

Fax: +33 472 18 2000

Netherlands

Breda

Tel: +31 76 578 3999

Fax: +31 76 578 3978

Poland

Warsaw

Tel: +48 22 843 3824

Fax: +48 22 843 3471

Portugal

Alfena

Tel: +351 229 69 8840

Fax: +351 229 69 8848

Lisbon

Tel: +351 212 109 340

Fax: +351 212 109 349

Russia

Moscow

Tel: +7 495 641 2359

Fax: +7 495 641 2358

U.A.E.

Dubai

Tel: +971 4 3381 861

Fax: +971 4 3382 343

U. K.

Middlesex

Tel: +44 1 895 43 0053

Fax: +44 1 895 45 9500

Sunderland

Tel: +44 191 522 2000

Fax: +44 191 522 2052

Asia – Pacific

Australia

Melbourne

Tel: +61 3 9 336 1300

Fax: +61 3 9 336 1322

Sydney

Tel: +61 2 9 896 4433

Fax: +61 2 9 896 3122

Asia – Pacific

Shanghai, China

Tel: +86 21 51113579

Fax: +86 21 51113578

Singapore

Tel: +65 6264 1188

Fax: +65 6862 4142

China

Beijing

Tel: +86 10 58674761

Fax: +86 10 58674760

Xi'an

Tel: +86 29 87891465

Fax: +86 29 87884504

Korea

Seoul

Tel: +82 2 3439 0400

Fax: +82 2 3439 0405

Philippines

Makati City

Tel: +63 2 844 9437

Fax: +63 2 844 4712

Factories

U.S.A.

Manitowoc

Shady Grove

Brazil

Alphaville

France

Charlieu

La Clayette

Moulins

India

Calcutta

Puna

Italy

Niella Tanaro

Germany

Wilhelmshaven

Portugal

Fânzeres

China

Zhangjiagang

