

## MDT 389 L16

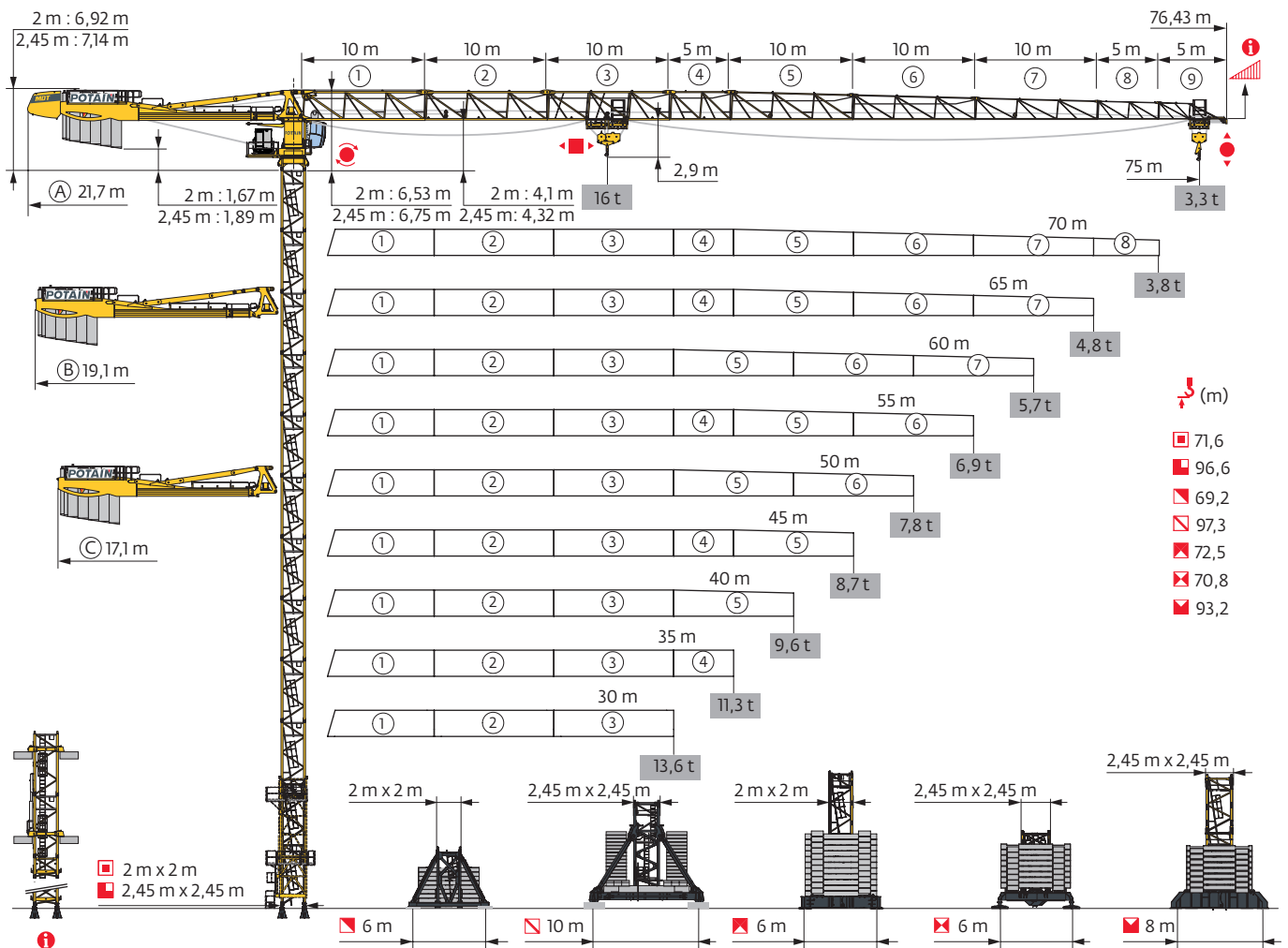

Potain Plus



Power Control

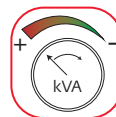

Top Site



Anti-collision systems

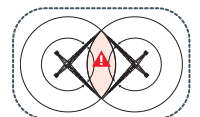

Mât - Réactions / Mast - Reaktionskräfte / Mast - Reactions / Mástil - Reacciones / Torre - Reazioni  
 Tramo - Reacções / Реакция опор мачты

**2 m - P 63A**

ΔΔΔΔ (m)	30	35	40	45	50	55	60	65	70	75
↕ (m)	71,6	68,2	69,9	71,6	71,6	71,6	69,9	71,6	71,6	71,6
↕/P+ (m)	63,2	61,6	61,6	63,2	63,2	64,9	64,9	66,6	66,6	66,6
	3,33 m	0	2	1	0	0	0	1	0	0
	5 m	12	10	11	12	12	11	12	12	12
	10 m	1	1	1	1	1	1	1	1	1
F2 (t)	● 219	212	215	221	222	222	219	223	229	230
	■ 256	237	249	258	265	266	258	277	284	291
F3 (t)	● 155	149	150	153	155	154	151	154	159	160
	■ 201	182	192	198	205	206	199	216	222	229

**2 m - V 60A**

ΔΔΔΔ (m)	30	35	40	45	50	55	60	65	70	75
↕ (m)	65,9	65,9	65,9	69,2	69,2	69,2	67,5	69,2	69,2	69,2
↕/P+ (m)	60,9	59,2	60,9	60,9	60,9	62,5	60,9	64,2	64,2	62,5
	3,33 m	0	0	0	1	1	1	2	1	1
	5 m	12	12	12	12	12	12	11	12	12
	F1 (t)	● 110	111	110	114	114	114	113	121	124
	■ 118	120	119	131	136	136	131	143	148	153

**2 m - ZX 640**

ΔΔΔΔ (m)	30	35	40	45	50	55	60	65	70	75
↕ (m)	70,9	67,5	69,2	70,9	70,9	70,9	69,2	70,9	72,5	72,5
↕/P+ (m)	62,5	62,5	62,5	62,5	62,5	64,2	64,2	65,9	67,5	65,9
	3,33 m	1	0	2	1	1	1	2	1	0
	5 m	11	13	10	11	11	11	10	11	12
	10 m	1	0	1	1	1	1	1	1	1
F1 (t)	● 119	117	119	121	122	122	118	125	134	137
	■ 139	125	134	139	143	144	139	150	162	166

**2,45 m - P 800B**

ΔΔΔΔ (m)	30	35	40	45	50	55	60	65	70	75
↕ (m)	81,6	81,6	81,6	81,6	79,9	79,9	79,9	78,2	78,2	76,6
↕/P+ (m)	81,6	81,6	81,6	81,6	79,9	79,9	79,9	78,2	78,2	76,6
	3,33 m	0	0	0	1	1	1	2	2	0
	5 m	16	16	16	16	15	15	15	14	14
	F2 (t)	● 226	227	226	225	222	220	221	224	225
	■ 327	330	330	328	323	325	327	323	331	318
F3 (t)	● 150	150	148	145	142	139	140	143	144	141
	■ 259	261	260	256	251	252	255	250	257	245

**2,45 m - P 854A**

ΔΔΔΔ (m)	30	35	40	45	50	55	60	65	70	75
↕ (m)	96,6	96,6	96,6	96,6	96,6	96,6	96,6	96,6	94,9	93,2
↕/P+ (m)	96,6	96,6	96,6	96,6	96,6	96,6	96,6	96,6	94,9	93,2
	3,33 m	0	0	0	0	0	0	0	1	2
	5 m	19	19	19	19	19	19	19	19	18
	F2 (t)	● 279	280	279	278	278	276	277	286	283
	■ 473	477	477	474	480	481	484	490	486	480
F3 (t)	● 191	190	188	186	187	184	185	193	191	189
	■ 393	395	394	390	396	397	400	405	401	396

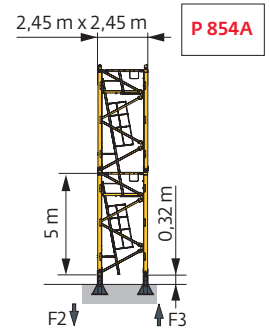
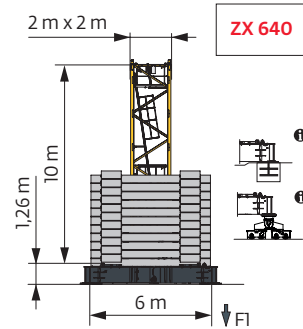
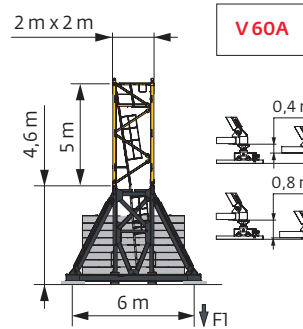
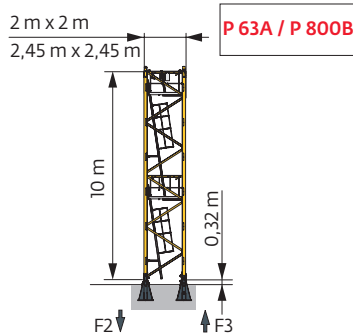

**2,45 m - JM 850**

ΔVΔ\ (m)	30	35	40	45	50	55	60	65	70	75
↑ (m)	97,3	97,3	97,3	97,3	97,3	97,3	97,3	97,3	97,3	95,7
↑/P↑ (m)	97,3	97,3	97,3	97,3	97,3	97,3	97,3	97,3	97,3	95,7
3,33 m	2	2	2	2	2	2	2	2	2	0
	5 m	16	16	16	16	16	16	16	16	17
Fl (t)	● 146	147	147	145	145	144	148	150	151	143
	■ 217	219	219	217	220	220	222	224	228	210

**2,45 m - ZX 6830**

ΔVΔ\ (m)	30	35	40	45	50	55	60	65	70	75
↑ (m)	70,8	70,8	70,8	70,8	70,8	70,8	69,2	69,2	67,5	67,5
↑/P↑ (m)	70,8	70,8	70,8	70,8	70,8	70,8	69,2	69,2	67,5	67,5
3,33 m	1	1	1	1	1	1	2	2	0	0
	5 m	13	13	13	13	13	12	12	13	13
Fl (t)	● 135	136	136	134	137	136	132	135	133	134
	■ 170	172	172	169	174	174	169	173	166	171

**2,45 m - ZY 800**

ΔVΔ\ (m)	30	35	40	45	50	55	60	65	70	75
↑ (m)	77,9	77,9	77,9	77,9	77,9	77,9	77,9	77,9	76,3	74,6
↑/P↑ (m)	77,9	77,9	77,9	77,9	77,9	77,9	77,9	77,9	76,3	74,6
3,33 m	0	0	0	0	0	0	0	0	1	2
	5 m	15	15	15	15	15	15	15	14	13
Fl (t)	● 127	131	128	128	129	129	132	135	134	130
	■ 168	170	171	168	173	174	176	181	179	176

**2,45 m - ZY 854**

ΔVΔ\ (m)	30	35	40	45	50	55	60	65	70	75
↑ (m)	93,2	93,2	93,2	93,2	93,2	93,2	93,2	93,2	91,5	89,9
↑/P↑ (m)	93,2	93,2	93,2	93,2	93,2	93,2	93,2	93,2	91,5	89,9
3,33 m	0	0	0	0	0	0	0	0	1	2
	5 m	18	18	18	18	18	18	18	17	16
Fl (t)	● 176	174	177	175	179	178	179	183	182	178
	■ 254	257	257	256	261	262	264	269	269	264

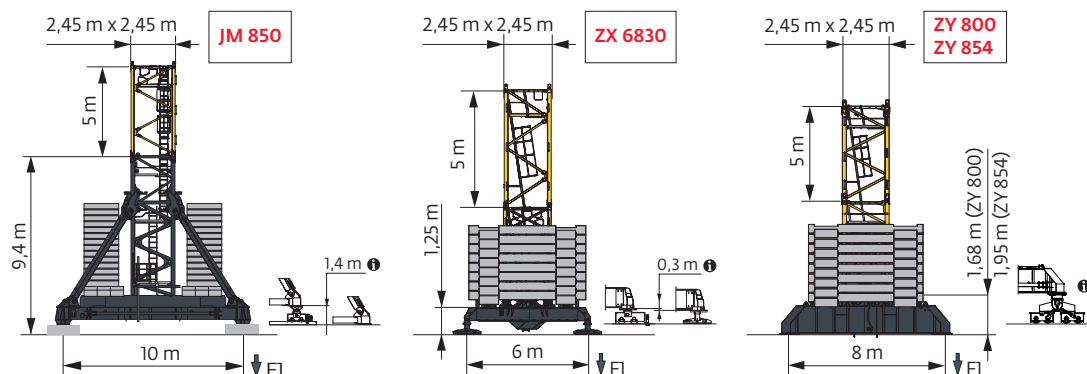

**i** Autres compositions de pylône - Nous consulter. / Andere Turmaufbauten - bitte kontaktieren Sie uns. / Other mast compositions - Please consult us. / Para otras composiciones de mástil - Por favor contáctenos. / Per altre composizioni torre, contattateci. / Para outras composições de coluna - Por favor, consulte-nos. / Для других композиций мачты пожалуйста консультируйтесь с нами.

Accès motorisés : compositions de mâture, de lest de base et réactions adaptées. / Motorisierter Zugang vom : Mastzusammensetzung, Grundballast und Reaktionskräfte sind angepasst. / Motorized accesses: adapted mast composition, base ballast and reactions. / Acceso a cabina con elevador: Adaptación de composición de mástil, lastre de base y reacciones. / Accessi motorizzati: composizioni elementi torre, zavorre di base e reazioni aggiornate. / Acessos motorizados: composições de coluna, lastro da base e reacções adaptadas. / Лифты : адаптированная композиция мачты, базовый балласт и нагрузки.

Ancrages / Verankerungen / Anchorages / Anclajes / Ancoraggi  
Ancoragem / нкпа

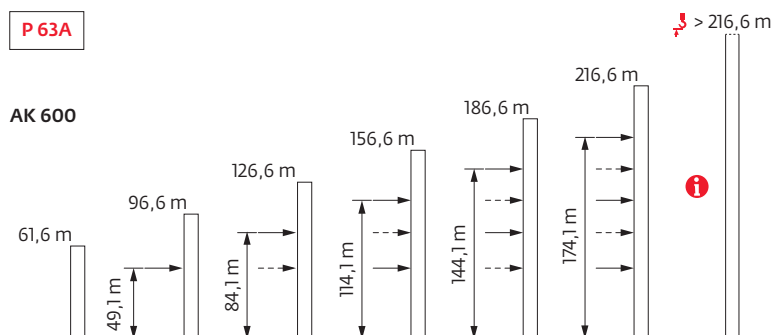

Lest de base / Grundballast / Base ballast / Lastre de base / Zavorra di base  
 Lastro da base / Базовый Балласт

**⚖️ (t) / 📏 2 m - V60A - 🚛**

▲▼▲ (m)	30	35	40	45	50	55	60	65	70	75
69,2				96	96	96		108	120	120
67,5				96	96	96	96	96	108	108
65,9	96	96	96	96	96	96	96	84	96	108
60,9	108	96	108	96	96	96	96	84	84	84
55,9	96	96	96	96	84	84	84	84	72	72
50,9	96	96	84	84	84	84	84	72	72	72
45,9	84	84	84	84	72	72	72	60	60	60
40,9	84	84	84	72	72	72	60	48	48	48
35,9	84	84	84	72	72	72	60	48	48	48

**⚖️ (t) / 📏 2 m - ZX 640 - 🚛**

▲▼▲ (m)	30	35	40	45	50	55	60	65	70	75
72,5									140	150
70,9	110				110	110	110		120	130
69,2	110		110	100	100	100	100	100	110	120
67,5	110	110	110	100	100	100	100	90	100	110
62,5	120	110	110	110	110	100	100	90	90	90
57,5	110	110	100	100	100	90	90	90	80	80
52,5	100	100	100	90	90	90	90	80	70	80
47,5	90	90	90	90	80	80	80	70	60	60
42,5	80	80	80	80	70	70	70	60	50	50
37,5	80	80	70	70	70	70	60	50	40	50

**⚖️ (t) / 📏 2,45 m - JM 850 - 🚛**

▲▼▲ (m)	30	35	40	45	50	55	60	65	70	75
97,3	168	168	168	156	156	156	168	168	168	
95,7	144	144	132	132	132	132	132	132	144	144
90,7	120	108	108	108	108	108	108	108	120	120
85,7	96	84	84	84	84	84	84	84	96	96
80,7	72	60	60	60	60	60	60	60	72	72
75,7↓	48	48	48	48	48	48	48	48	48	48
35,7	48	48	48	48	48	48	48	48	48	48

**⚖️ (t) / 📏 2,45 m - ZX 6830 - 🚛**

▲▼▲ (m)	30	35	40	45	50	55	60	65	70	75
70,8	151	151	151	141	151	151				
69,2	141	141	141	131	141	141	141	141		
67,5	131	131	121	121	121	121	131	131	141	141
62,5	101	101	101	101	91	91	91	91	101	111
57,5	91	91	91	81	81	71	71	71	71	71
52,5	81	81	81	71	71	71	61	61	51	51
47,5	81	81	81	71	71	71	61	51	41	51
42,5	81	81	81	71	71	71	61	51	41	51
37,5	81	81	81	71	71	71	61	51	41	51

**⚖️ (t) / 📏 2,45 m - ZY 800 - 🚛**

▲▼▲ (m)	30	35	40	45	50	55	60	65	70	75
77,9	108	120	108	108	108	108	120	120		
76,3	108	108	108	96	108	108	108	108	120	
74,6	96	96	96	96	96	96	96	96	108	108
69,6	72	72	72	60	72	72	72	72	72	84
64,6	48	48	48	48	36	36	48	48	48	60
59,6	48	36	36	36	36	24	24	24	24	24
54,6	36	36	24	24	24	24	24	12	12	12
49,6↓	24	24	24	24	24	12	12	12	12	12
34,6	24	24	24	24	24	12	12	12	12	12

**⚖️ (t) / 📏 2,45 m - ZY 854 - 🚛**

▲▼▲ (m)	30	35	40	45	50	55	60	65	70	75
93,2	216	204	216	204	216	216	216	216		
91,5	204	204	204	192	204	204	204	204	216	
89,9	192	192	192	180	192	192	192	192	204	204
84,9	156	156	156	144	156	156	156	156	168	168
79,9	120	120	120	108	120	120	120	132	132	132
74,9	96	96	96	84	84	84	84	96	96	108
69,9	60	60	60	60	60	60	60	60	72	72
64,9	36	36	36	36	36	36	36	36	48	48
59,9	36	36	24	24	24	12	12	12	24	24
54,9	24	24	24	12	12	12	12	12	12	12
49,9	24	12	12	12	12	12	12	12	12	12
44,9↓	12	12	12	12	12	12	12	12	12	12
34,9	12	12	12	12	12	12	12	12	12	12

Courbes de charges / Lastkurven / Load curves / Curvas de cargas / Curve di carico / Curvas de carga / Кривые нагрузок



▼▲▲▲▲ (m)		17	20	25	27	30	32	35	37	40	42	45	47	50	55	57	60	65	67	70	72	75	m	
▼▲▲▲▲	↔ 16 t	↔ 8 t	↔										↔											
75	3,3 → 18,6	34,1-37,3	16	14,9	11,6	10,6	9,4	8,7	8	8	7,4	7	6,5	6,1	5,6	4,9	4,7	4,4	3,9	3,7	3,5	3,3	3,1	t
	3,3 → 20,5	36-39,1	16	16	12,8	11,7	10,3	9,4	8,3	8	7,7	7,3	6,7	6,3	5,8	5,2	4,9	4,6	4,1	4	3,7	3,6	3,3	t P+
70	3,3 → 19,7	35,9-39,1	16	15,7	12,3	11,3	10	9,3	8,3	8	7,7	7,2	6,6	6,2	5,7	5	4,8	4,5	4	3,9	3,7		t	
	3,3 → 21,1	36,4-39,7	16	16	13,2	12	10,5	9,6	8,5	8	7,8	7,4	6,8	6,4	5,9	5,3	5	4,7	4,2	4	3,8		t P+	
65	3,3 → 21,1	38,8-42	16	16	13,3	12,2	10,8	10	9	8,5	8	8	7,4	7	6,5	5,7	5,4	5,1	4,6				t	
	3,3 → 22,5	39,4-42,6	16	16	14,1	12,8	11,3	10,4	9,3	8,7	8	8	7,5	7,1	6,6	5,9	5,6	5,3	4,8				t P+	
60	3,3 → 22,4	40,4-43,5	16	16	14,1	12,9	11,4	10,6	9,5	8,9	8,1	8	7,7	7,3	6,8	6,1	5,8	5,5					t	
	3,3 → 24	42-45,2	16	16	15,2	13,9	12,2	11,3	10,1	9,4	8,5	8	8	7,6	7,1	6,3	6	5,7					t P+	
55	3,3 → 22,7	41,8-45,1	16	16	14,4	13,2	11,8	10,9	9,9	9,2	8,4	8	8	7,6	7,1	6,4								t
	3,3 → 24,4	44,4-48	16	16	15,5	14,3	12,7	11,8	10,6	9,9	9,1	8,6	8	8	7,6	6,9								t P+
50	3,3 → 22,7	41,9-45,2	16	16	14,4	13,2	11,8	10,9	9,9	9,3	8,5	8	8	7,7	7,1									t
	3,3 → 24,8	45,4-49	16	16	15,9	14,6	13	12	10,9	10,2	9,3	8,8	8,1	8	7,8									t P+
45	3,3 → 23,7	43,7-45	16	16	15,1	13,9	12,4	11,5	10,4	9,7	8,9	8,4	8											t
	3,3 → 25,9		16	16	16	15,3	13,6	12,7	11,4	10,7	9,8	9,2	8,5											t P+
40	3,3 → 23,5		16	16	14,9	13,6	12,1	11,2	10,1	9,4	8,6													t
	3,3 → 25,5		16	16	16	15	13,3	12,3	11,1	10,4	9,5													t P+
35	3,3 → 23,7		16	16	15	13,8	12,2	11,3	10,2															t
	3,3 → 25,8		16	16	16	15,2	13,4	12,4	11,2															t P+
30	3,3 → 23,8		16	16	15,1	13,9	12,3																	t
	3,3 → 25,8		16	16	16	15,3	13,5																	t P+

$↔ = ↔ - 0,88 \text{ t max.}$



▼▲▲▲▲ (m)		17	20	25	27	30	32	35	37	40	42	45	47	50	55	57	60	65	67	70	72	75	m	
▼▲▲▲▲	↔ 16 t	↔ 8 t	↔										↔											
75	2,5 → 18,8	34,6-35,6	16	15	11,7	10,8	9,5	8,8	8	7,6	7	6,6	6	5,6	5,2	4,5	4,2	3,9	3,4	3,3	3	2,85	2,65	t
	2,5 → 20,6	36,5-37,2	16	16	12,9	11,8	10,5	9,6	8,4	8	7,3	6,8	6,2	5,9	5,4	4,7	4,5	4,1	3,7	3,5	3,2	3,1	2,85	t P+
70	2,5 → 19,8	36,4-37,2	16	15,8	12,5	11,4	10,1	9,4	8,4	8	7,3	6,8	6,1	5,8	5,3	4,6	4,3	4	3,6	3,4	3,2			t
	2,5 → 21,3	36,9-38	16	16	13,3	12,2	10,6	9,7	8,6	8	7,4	6,9	6,3	6	5,5	4,8	4,6	4,2	3,7	3,6	3,4			t P+
65	2,5 → 21,3	39,4-40,2	16	16	13,4	12,3	11	10,2	9,2	8,6	8	7,6	7	6,6	6,1	5,3	5	4,7	4,2					t
	2,5 → 22,6	39,9-40,8	16	16	14,2	13	11,4	10,5	9,4	8,8	8	7,7	7,1	6,7	6,2	5,5	5,2	4,9	4,4					t P+
60	2,5 → 22,6	41-42	16	16	14,3	13,1	11,6	10,7	9,7	9	8,2	8	7,3	7	6,5	5,7	5,5	5,2						t
	2,5 → 24,2	42,6-43,5	16	16	15,4	14	12,4	11,4	10,2	9,6	8,7	8,1	7,7	7,3	6,7	5,9	5,7	5,3						t P+
55	2,5 → 22,9	42,5-43,4	16	16	14,5	13,4	11,9	11,1	10	9,4	8,6	8,1	7,7	7,3	6,8	6,1								t
	2,5 → 24,5	45,1-46,1	16	16	15,7	14,4	12,8	11,9	10,7	10,1	9,2	8,7	8	7,8	7,3	6,5								t P+
50	2,5 → 22,9	42,5-43,5	16	16	14,6	13,4	11,9	11,1	10	9,4	8,6	8,1	7,7	7,3	6,8									t
	2,5 → 25	46,1-46	16	16	16	14,7	13,1	12,2	11	10,3	9,5	8,9	8,2	7,9	7,5									t P+
45	2,5 → 23,9	44,4-45	16	16	15,3	14	12,5	11,6	10,5	9,9	9	8,5	8											t
	2,5 → 26,1		16	16	16	15,4	13,7	12,8	11,6	10,9	9,9	9,4	8,7											t P+
40	2,5 → 23,7		16	16	15	13,8	12,2	11,3	10,2	9,6	8,7													t
	2,5 → 25,7		16	16	16	15,1	13,4	12,4	11,2	10,5	9,6													t P+
35	2,5 → 23,9		16	16	15,2	13,9	12,3	11,4	10,3															t
	2,5 → 26		16	16	16	15,3	13,6	12,6	11,3															t P+
30	2,5 → 24		16	16	15,3	14	12,4																	t
	2,5 → 26		16	16	16	15,4	13,6																	t P+



$↔ = ↔ - 0,27 \text{ t max.}$

Poids de flèche & lest de contre-flèche / Auslegergewicht & Gegenauslegerballast / Jib weight & counter-jib ballast / Peso de flecha y lastre de contra-flecha/Peso del braccio & zavorra di contro-braccio/Peso da lança & lastro da contra lança/Вес стрелы и балласт контр-стрелы

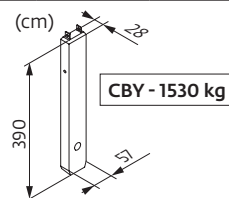
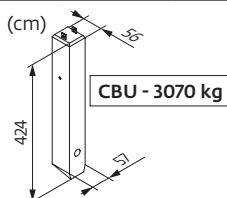
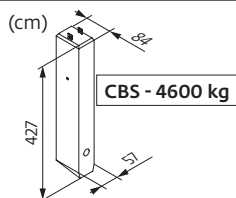







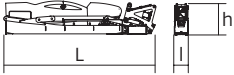

▼▲▲▲▲	▼▲▲▲▲ (kg) (+/- 5%)			▨		▨			
	↔↔	↔	↔↔↔↔	4600 kg	1530 kg	▨ (kg)	3070 kg	1530 kg	▨ (kg)
75 m	18300	17805	18450	5	2	26060	8	1	26090
70 m	18035	17555	18175	5	2	26060	8	1	26090
65 m	17650	17200	17820	5	2	26060	8	1	26090
60 m	16725	16305	16875	5	1	24530	8	0	24560
55 m	16735	16315	16885	5	1	24530	8	0	24560
50 m	15920	15500	16070	5	2	26060	8	1	26090
45 m	15660	15240	15810	5	2	26060	8	1	26090
40 m	14845	14425	14995	5	0	23000	7	1	23020
35 m	14315	13895	14465	4	2	21460	7	0	21490
30 m	13475	13055	13625	4	1	19930	6	1	19950

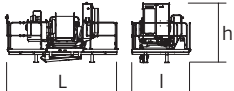
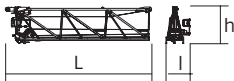
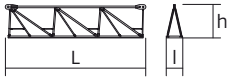
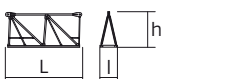
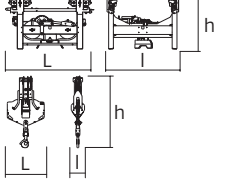

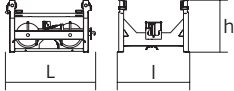

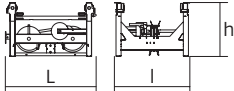

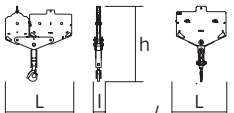

Encombrenment et poids / Abmessungen und Gewicht / Dimensions and weight / Dimensiones y peso / Ingombro e peso  
dimensões e pesos / габаритные размеры и вес

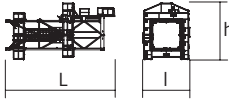
Partie tournante / Drehender Kranteil / Slewing crane part / Parte giratoria  
Parte rotante / Parte rotativa / Поворотная часть :  75 m -  75/90 HPL™

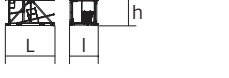
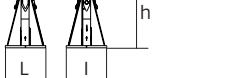
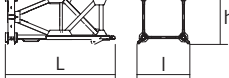

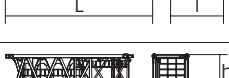
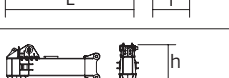
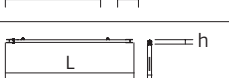
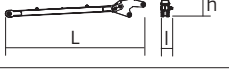
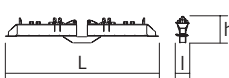
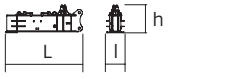
Partie tournante / Drehender Kranteil / Slewing crane part Parte giratoria / Parte rotante / Parte rotativa / Поворотная часть		L (m)	I (m)	h (m)	kg (+/- 5%)	
Contre-flèche / Gegenausleger Counter-jib / Contra-flecha Controbraccio / Contra-lança Контр-стрела		12 12 12	1,25 1,25 1,25	2,5 2,5 2,5	14110 13600 11540	
Mât-cabine + cabine / Kabinenmast + Kabine Cab mast + cab / Mástil-cabina + cabina Portaralla superiore + cabina / Tramo-cabina + cabina Секция мачты кабины + кабина					Ultra View 6720	
Pivot / Krankopf Towerhead / Pivote Portaralla / Pivot Секция поворотной части		2 m 2,45 m	2,95 3,25	2,48 2,5 2,75	7620 8700	
Treuil de levage (+ câble) / Hubwerk (+ Seil) Hoisting winch (+ rope) / Mecanismo de elevación (+ cabo) Argano di sollevamento (+ fune) Guincho de elevação (+ cabo) Подъёмная лебёдка (+ канатом)		75/90 HPL™ 110/132 HPL™	4,27 4,86	2,3 2,28 2,52	4090 6870	
Elément de flèche / Auslegerelement Jib section / Elemento de flecha Elemento di braccio / Elemento de lança Секция стрелы		① 6 DVF	10,75	1,8 2,74	5450	
Elément de flèche / Auslegerelement Jib section / Elemento de flecha Elemento di braccio / Elemento de lança Секция стрелы		② ③ ⑤ ⑥ ⑦	10,21 10,31 10,22 10,24 10,19	1,2 1,2 1,2 1,2 1,2	2,5 2,42 2,39 2,1 1,83	3145 2420 1560 1235 950
Elément de flèche / Auslegerelement Jib section / Elemento de flecha Elemento di braccio / Elemento de lança Секция стрелы		④ ⑧ ⑨	5,27 5,09 5,09	1,2 1,2 1,2	2,39 1,53 1,39	960 310 220
Chariot + Moufle / Laufkatze + Hubflasche Trolley + Pulley block / Carrello + Aparejo Carro + Bozzello / Carro-distribuidor + Cadernal Тележка + Полиспаст		 16 t	2,05 1,41	1,51 0,45	1,09 2,22	482 590
Chariot / Laufkatze Trolley / Carrello Carro / Carro-distribuidor Тележка		 16 t	1,77	1,53	1,05	250
Chariot / Laufkatze Trolley / Carrello Carro / Carro-distribuidor тележка		 16 t  8 t	1,77 1,82	1,53 1,53	1,05 1,05	303 303
Moufle / Hubflasche Pulley block / Aparejo Bozzello / Cadernal Полиспаст		 16 t  8 t	1,83 1,16	0,28 0,22	1,9 1,6	845 370

Pyłõne / Kranturm / Crane tower Mástil / Torre / Torre / Башня крана		L (m)	l (m)	h (m)	kg (+/- 5%)	
T 61 T 851		2 m 2,45 m	10,83 11,18	4,14 4,84	4,47 5,8	9700 15750
K 649B KM 649E KRM 6410B KRM 849B K 85/KR 84B2 KM 850.10B KM 850.14B		2 m 2 m 2 m 2,45 m 2,45 m 2,45 m 2,45 m	10,23 10,29 10,23 10,24 10,24 10,32 10,32	2,07 2,03 2,1 2,55 2,54 2,54 2,54	2,03 2,03 2,08 2,53 2,5 2,51 2,51	5290 4850 7100 7800 9635 10070 11190
K 649A KMT 649A KR 649A KRMT 649A K 849A KMT 849A KR 849A KRMT 849A K 85/KR 84A2 KMT 850.10A KMT 850.14A		2 m 2 m 2 m 2 m 2,45 m 2,45 m 2,45 m 2,45 m 2,45 m 2,45 m 2,45 m	5,23 5,23 5,23 5,23 5,23 5,23 5,23 5,23 5,24 5,32 5,32	2,07 2,07 2,1 2,1 2,53 2,55 2,53 2,55 2,54 2,54 2,54	2,03 2,03 2,08 2,08 2,5 2,53 2,5 2,53 2,5 2,51 2,51	2805 2570 3250 3050 3400 3150 4290 4090 5550 5450 5990
K 649C KMT 649C KRMT 649C KRMT 849C		2 m 2 m 2 m 2,45 m	3,57 3,57 3,57 3,57	2,07 2,07 2,1 2,55	2,03 2,03 2,08 2,53	2070 2060 2450 3205
Pieds de scellement / VerankerungsfüÙe Fixing angles / Pie de empotramiento Montante da annegare / Angulos fixadores анкера		P 63A / P 800B P 854A	0,75 0,9	0,75 0,9	1,28 1,5	465 940
Mât-châssis / Grundmasteinheit Basic mast unit / Tramo-chassis Elemento base / Tramo-chassis Мачта для крепления к шасси		V 60A	5,01	2,41	2,41	4760
Haubans / Mastabstützungen / Struts / Tornapuntas Puntoni / Escoras / Растяжка		V 60A	4,51	0,29	0,29	470
Sommier / Unterwagenhälfte Half-bearer / Testero Testata / Estrutura base Траверса		V 60A	6,7	0,7	2,31	1840
Croix centrale (position transport) / Zentralkreuz (Transport- position) / Central cross (transport position) / Brazo central (posición transporte) / Croce centrale (posizione di trasporto) Braço central chassis (posição transporte) / крестообразное основание (транспортное положение)		JM 850	5,2	1,7	1,5	6700
Mât-châssis / Grundmasteinheit Basic mast unit / Tramo-chassis Elemento base / Tramo-chassis Мачта для крепления к шасси		JM 850	8,75	2,5	2,5	14600
Bras de châssis / Unterwagenträger / Chassis girder / Brazo de base en cruz / Traverso del carro / Braço de chassis / опорная балка шасси		JM 850	5,2	0,9	1,55	3200
Tirant de châssis / Unterwagenstreben / Chassis ties / Tirante de base en cruz / Tiranti del carro / Tirante de chassis / тяга крепления шасси		JM 850	7,2	0,25	0,35	250
Haubans / Mastabstützungen / Struts / Tornapuntas Puntoni / Escoras / Растяжка		JM 850	8,2	0,75	1,3	2300
Bras de croix / Fundamentkreuzträger Cross girder / Brazo en cruz / Braccio croce / Braço da cruz Поперечная балка		ZX 6830	9,1 9,1	1,12 0,76	1,1 1,48	5265 5445
1/2 Bras de croix / 1/2 Fundamentkreuzträger 1/2 Cross girder / 1/2 Brazo en cruz 1/2 Braccio croce / 1/2 Braço da cruz 1/2 Поперечная балка		ZX 640 ZY 800 ZY 854	4,35 5,68 5,7	1 0,98 0,98	1,56 1,92 2,27	3320 4720 6430
Bras de croix / Fundamentkreuzträger Cross girder / Brazo en cruz / Braccio croce / Braço da cruz Поперечная балка		ZX 640 ZY 800 ZY 854	9,15 11,96 11,9	1,19 1,39 1,42	1,56 1,92 2,27	6880 10075 14000

Mécanismes / Triebwerke / Mechanisms / Mecanismos / Meccanismi  
Mecanismos / Механизмы

400 V - 50 Hz 480 V - 60 Hz													ch - PS hp	kW		
	400 V - 50 Hz	75 HPL™ 40	m/min t	33,5 8	44 6	63 4	110 2	167 0,5	17,5 16	23 12	33 8	57,5 4	83,5 1,4	75	55	539 m
	480 V - 60 Hz	90 HPL™ 40	m/min t	40,5 8	53 6	76 4	111,5 2	167 0,5	21 16	27,5 12	39,5 8	58 4	83,5 1,4	90	66	
	400 V - 50 Hz	110 HPL™ 40	m/min t	50,5 8	65,5 6	92 4	134 2	194 0,2	26 16	34 12	48 8	68,5 4	102,5 0,4	110	82	1140 m
	480 V - 60 Hz	132 HPL™ 40	m/min t	60,5 8	79 6	110,5 4	160 2	204,5 0,7	31 16	41 12	57,5 8	82 4	102,5 1,8	132	98	
		6 DVF 6 Optima	m/min	0 → 42 (16 t) 0 → 84 (8 t) 0 → 100 (4 t)										5,5	4	
	400 V - 50 Hz 480 V - 60 Hz	RVF 172 Optima+	tr/min U/min rpm	400 V - 50 Hz : 0 → 0,8 480 V - 60 Hz : 0 → 0,9										2 x 10	2 x 7,5	

	IEC 60204-32	kVA
400 V (+10% -10%) 50 Hz	75 HPL™ : 84 → 54 kVA 110 HPL™ : 112 → 68 kVA	
480 V (+6% -10%) 60 Hz	90 HPL™ : 96 → 60 kVA 132 HPL™ : 130 → 77 kVA	

	FR	DE	EN	ES	IT	PT	RU
	Appel de flèche	Auslegerüberhöhung	Jib elevation	Elevación de la flecha	Inclinazione braccio	Desvio da lança	подъем стрелы
	Équipements standards	Standardausrüstungen	Standard equipment	Equipamiento de serie	Equipaggiamento standard	Equipamento de série	Стандартное оборудование
	Équipements optionnels	Sonderausrüstungen	Options	Equipamiento opcional	Equipaggiamento in opzione	Equipamento opcional	Дополнительное оборудование (опция)
	Fonction Potain Plus : Courbes de charges Plus	Funktion Potain Plus: Plus-Lastkurven	Potain Plus function: Plus load curves	Función Potain Plus: Diagrama de cargas Plus	Funzione Potain Plus: Curve di carico Plus	Função Potain Plus: Diagrama de cargas Plus	Функция контроля мощности Potain Plus: Диаграммы грузоподъемности Plus
	Hauteurs sous crochet associées aux courbes de charges Plus	Hakenhöhen mit Plus-Lastkurven	Hook heights with Plus load curves	Altura bajo gancho, usando el diagrama de cargas Plus	Altezze sotto gancio con curve di carico Plus	Altura livre, utilizando o diagrama de cargas Plus	Высота под крюком для диаграмм грузоподъемности Plus
	Réactions en service	Reaktionskräfte in Betrieb	Reactions in service	Reacciones en servicio	Reazioni in servizio	Reacções em serviço	Реакция при работе
	Réactions hors service	Reaktionskräfte außer Betrieb	Reactions out of service	Reacciones fuera de servicio	Reazioni fuori servizio	Reacções fora de serviço	Реакция в покое
	Poids total du lest	Ballast-Gesamtgewicht	Total ballast weight	Peso total del lastre	Peso totale della zavorra	Peso total do lastro	Общий вес балласта
	Cadre d'ancrage serré	Fester Verankerungsrahmen	Tightened anchorage frame	Marco de anclaje de apriete	Quadro di ancoraggio stretto	Quadro de amarração apertado	Прикрепленная анкерная рама
	Cadre d'ancrage desserré	Loser Verankerungsrahmen	Loosened anchorage frame	Marco de anclaje de desapriete	Quadro di ancoraggio allentato	Quadro de amarração solto	Отсоединенная анкерная рама
	Poids de flèche	Auslegergewicht	Jib weight	Peso de flecha	Peso del braccio	Peso da lança	вес стрелы
	Camion 13,4 m	Lkw 13,4 m	Lorry 13,4 m	Camión 13,4 m	Camion 13,4 m	Camião 13,4 m	Ррузовой автомобиль 13,4 м
	Conteneur High Cube 40', et/ou Flat Rack 20'	Container High Cube 40', und/oder Flat Rack 20'	Container High Cube 40', and/or Flat Rack 20'	Contenedor High Cube 40', y/o Flat Rack 20'	Container High Cube 40', e/o Flat Rack 20'	Contentor High Cube 40', e/ou Flat Rack 20'	40-футовый контейнер повышенной вместимости High Cube, и/или 20-футовая открытая платформа Flat Rack
	Levage	Heben	Hoisting	Elevación	Sollevamento	Elevação	Подъем
	Distribution	Katzfahren	Trolleying	Distribución	Ditribuzione	Distribuição	Перемещение по стреле
	Orientation	Schwenken	Slewing	Orientación	Rotazione	Rotação	Поворот
	Translation	Kranfahren	Travelling	Traslación	Traslazione	Translação	Перемещение крана
	Puissance requise	Erforderliche Leistung	Required power	Potencia Necesaria	Potenza richiesta	Potência Necessária	Потребляемая мощность
	Fonction Power Control : vitesses treuils adaptées à la puissance disponible	Funktion Power Control: Geschwindigkeiten der Triebwerke werden an die verfügbare Leistung angepasst	Power Control Function: winch speeds adapted to the available power	Función Power Control: marchas de los cabrestantes adaptadas a la potencia disponible	Funzione Power Control: velocità degli argani adattate alla potenza disponibile	Função Power Control: velocidades de guincho adaptadas à potência disponível	Функция контроля мощности Power Control: регулировка скорости лебедок в зависимости от доступной мощности
	Nous consulter	Auf Anfrage	Consult us	Consultarnos	Consultateci	Consultar-nos	Проконсультируйтесь у нас
	Document commercial non contractuel. Pour toute information technique se référer à la notice correspondante.	Unverbindliches Vertriebsdokument. Für technische Informationen, siehe die entsprechenden Anweisungen.	This commercial document is not legally binding. For any technical information, please refer to the corresponding instructions.	Documento comercial no contractual. Para cualquier información técnica, ver la noticia correspondiente.	Documento commerciale non vincolante, per tutte le informazioni tecniche fare riferimento al catalogo istruzioni.	Documento comercial não contratual. Para qualquer informação técnica complementar consultar as respectivas instruções.	Этот коммерческий документ не является юридически обязательным. Для получения технической информации, см. соответствующие инструкции.

