

MDT 319

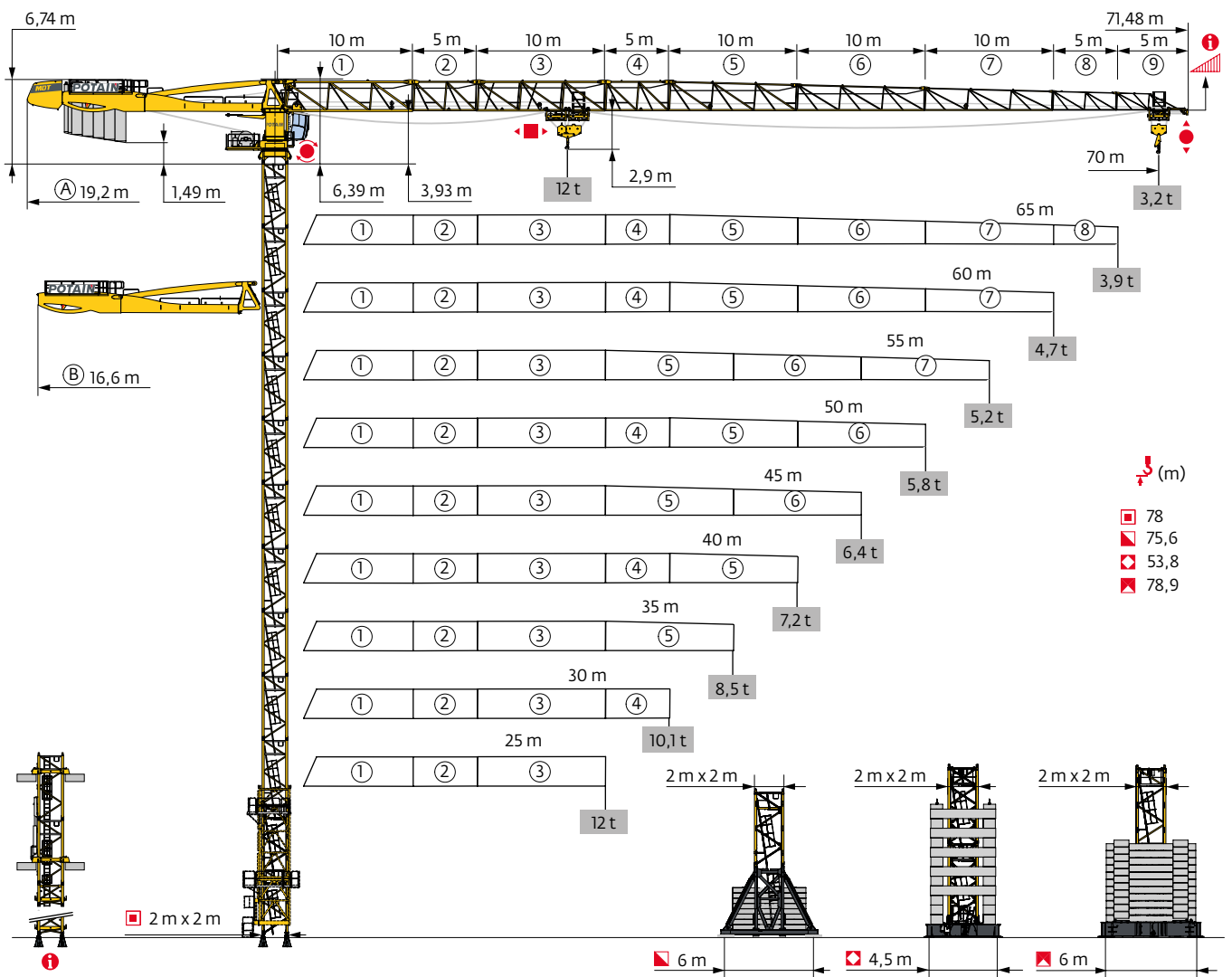

Potain Plus



Power Control

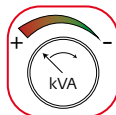

Top Site

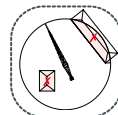

Anti-collision systems

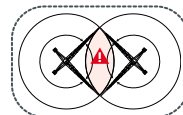

Automatic Rotation Control



Mât - Réactions / Mast - Reaktionskräfte / Mast - Reactions / Mástil - Reacciones / Torre - Reazioni
 Tramo - Reacções / Реакция опор мачты

2 m - P 63A										
ΔΔΔΔ (m)	25	30	35	40	45	50	55	60	65	70
↓ (m)	78	78	78	78	78	76,3	76,3	76,3	76,3	76,3
↓/P+ (m)	78	78	78	78	78	76,3	76,3	76,3	76,3	76,3
	3,33 m	2	2	2	2	0	0	0	0	0
	5 m	12	12	12	12	13	13	13	13	13
	10 m	1	1	1	1	1	1	1	1	1
F2 (t)	●	211	217	217	221	221	217	219	227	229
	■	318	323	322	328	326	318	319	323	329
F3 (t)	●	162	161	159	162	161	157	157	164	166
	■	270	272	271	275	272	264	264	266	272

2 m - V 60A -										
ΔΔΔΔ (m)	25	30	35	40	45	50	55	60	65	70
↓ (m)	68,9	68,9	68,9	68,9	68,9	68,9	68,9	70,6	68,9	67,3
↓/P+ (m)	68,9	68,9	68,9	68,9	68,9	68,9	68,9	70,6	68,9	67,3
	3,33 m	1	1	1	1	1	1	0	1	2
	5 m	12	12	12	12	12	12	13	12	11
F1 (t)	●	111	112	112	113	113	114	119	118	117
	■	141	143	142	145	143	147	153	151	148

2 m - V 63A -										
ΔΔΔΔ (m)	25	30	35	40	45	50	55	60	65	70
↓ (m)	75,6	75,6	75,6	75,6	75,6	75,6	75,6	75,6	74	74
↓/P+ (m)	75,6	75,6	75,6	75,6	75,6	75,6	75,6	75,6	74	74
	3,33 m	0	0	0	0	0	0	0	1	1
	5 m	13	13	13	13	13	13	13	12	12
F1 (t)	●	130	132	131	132	132	133	133	134	134
	■	175	176	176	178	177	181	181	179	181

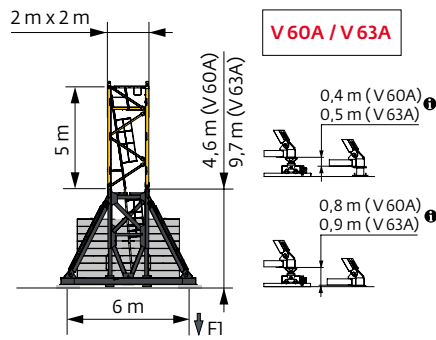
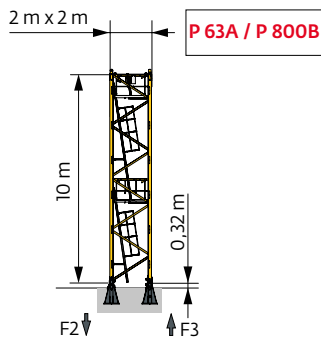



i Autres compositions de pylône - Nous consulter. / Andere Turmaufbauten - bitte kontaktieren Sie uns. / Other mast compositions - Please consult us. / Para otras composiciones de mástil - Por favor contáctenos. / Per altre composizioni torre, contattateci. / Para outras composições de coluna - Por favor, consulte-nos. / Для других композиций мачты пожалуйста проконсультируйтесь с нами.

Accès motorisés : compositions de mâture, de lest de base et réactions adaptées. / Motorisierter Zugang vom : Mastzusammensetzung, Grundballast und Reaktionskräfte sind angepasst. / Motorized accesses: adapted mast composition, base ballast and reactions. / Acceso a cabina con elevador: Adaptación de composición de mástil, lastre de base y reacciones. / Accessi motorizzati: composizioni elementi torre, zavorre di base e reazioni aggiornate. / Acessos motorizados: composições de coluna, lastro da base e reacções adaptadas. / Лифты : адаптированная композиция мачты, базовый балласт и нагрузки.

2 m - ZD 640 - 

ΔL (m)	25	30	35	40	45	50	55	60	65	70	
\downarrow (m)	52,1	48,8	50,5	48,8	50,5	52,1	52,1	52,1	53,8	52,1	
\downarrow/P_+ (m)	52,1	48,8	50,5	48,8	50,5	50,5	50,5	50,5	52,1	52,1	
	3,33 m	0	2	1	2	1	0	0	0	2	0
	5 m	10	8	9	8	9	10	10	10	9	10
Fl (t)	● 105	105	107	107	108	111	111	112	116	115	
	■ 101	96	100	99	101	109	109	108	119	115	

2 m - ZX 640 - 

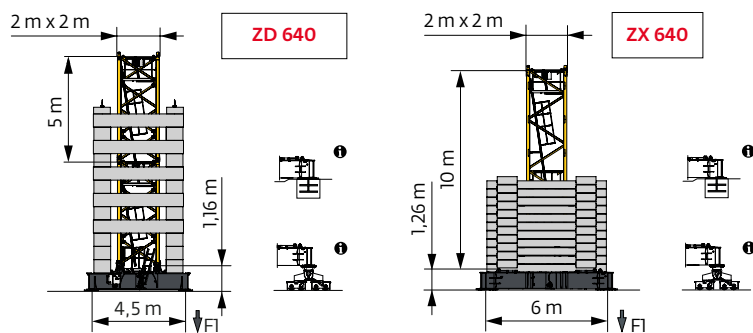

ΔL (m)	25	30	35	40	45	50	55	60	65	70
\downarrow (m)	78,9	78,9	78,9	78,9	78,9	77,3	77,3	77,3	77,3	75,6
\downarrow/P_+ (m)	78,9	78,9	78,9	78,9	78,9	77,3	77,3	77,3	77,3	75,6
	3,33 m	2	2	2	2	0	0	0	0	1
	5 m	12	12	12	12	13	13	13	13	12
	10 m	1	1	1	1	1	1	1	1	1
Fl (t)	● 138	141	141	143	143	140	140	138	144	140
	■ 188	190	190	193	191	186	187	185	188	184



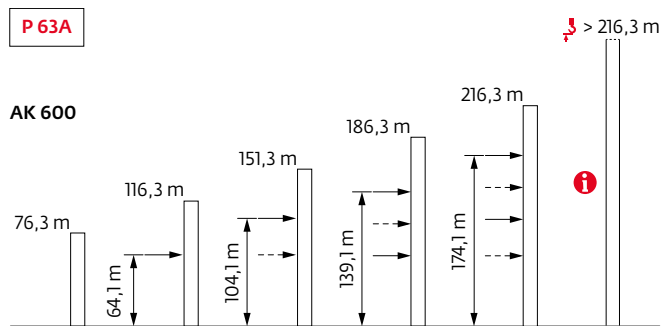



Ancrages / Verankerungen / Anchorages / Anclajes / Ancoraggi
 Ancoragem / нкрепа





Lest de base / Grundballast / Base ballast / Lastre de base / Zavorra di base
 Lastro da base / Базовый Балласт

 (t) / 2 m - V 60A - 										
Δh (m)	25	30	35	40	45	50	55	60	65	70
70,6	132									
68,9	132	132	132	132	132	132	132	132	132	
67,3	132	132	120	120	120	120	120	120	120	132
62,3	96	96	96	96	96	96	96	84	96	96
57,3	72	72	72	72	72	72	72	72	72	72
52,3	60	72	60	72	60	60	60	60	60	60
47,3	60	60	60	60	60	48	48	48	48	48
42,3	48	48	48	48	48	48	48	48	48	48
37,3	48	48	48	48	48	48	48	48	36	48
32,3	48	48	48	48	48	48	48	48	36	48
27,3	48	48	48	48	48	48	48	48	36	36
22,3	48	48	48	48	48	48	48	48	36	36

 (t) / 2 m - V 63A - 										
Δh (m)	25	30	35	40	45	50	55	60	65	70
75,6	180	180	180	180	180	180	180	180	168	
74	168	168	168	168	168	168	168	168	156	168
69	144	144	132	132	132	132	144	132	132	144
64	108	108	108	108	108	108	108	96	108	120
59	84	84	84	84	72	84	84	72	84	84
54	60	72	60	72	60	60	60	60	60	60
49	60	60	60	60	60	48	48	48	48	48
44	48	48	48	48	48	48	48	48	48	48
39	48	48	48	48	48	48	48	36	36	48
34	48	48	48	48	48	48	48	36	36	48
29	48	48	48	48	48	48	48	36	36	36
24	48	48	48	48	48	48	48	36	36	36

 (t) / 2 m - ZD 640 - 										
Δh (m)	25	30	35	40	45	50	55	60	65	70
53,8	125									
52,1	125					125	125	125	125	125
50,5	120		125		125	125	125	120	120	
48,8	120	125	125	125	120	120	120	120	120	110
43,8	110	120	110	120	110	110	110	110	100	100
38,8	100	110	100	110	100	100	100	100	90	90
33,8	90	100	100	100	90	90	90	90	80	90
28,8	90	100	100	100	90	90	90	90	80	80
23,8	90	100	100	100	90	90	90	90	80	80

 (t) / 2 m - ZX 640 - 										
Δh (m)	25	30	35	40	45	50	55	60	65	70
78,9	200	200	200	200	200					
77,3	190	180	180	190	180	190	190	180	190	
75,6	170	170	170	170	170	180	180	170	180	180
70,6	140	140	130	140	130	140	140	130	140	150
65,6	110	110	100	110	100	110	110	100	110	120
60,6	80	80	80	80	80	80	80	80	80	80
55,6	70	80	80	80	70	70	70	70	70	60
50,6	60	70	60	70	60	60	60	60	60	50
45,6	50	60	60	60	50	50	50	50	50	50
40,6	40	50	50	50	50	50	50	40	40	40
35,6	40	50	50	50	50	40	40	40	40	40
30,6	40	50	50	50	50	40	40	40	40	40
25,6	40	50	50	50	50	40	40	40	40	40
20,6	40	50	50	50	50	40	40	40	40	40

Courbes de charges / Lastkurven / Load curves / Curvas de cargas / Curve di carico / Curvas de carga / Кривые нагрузок



↕ (m)			22	25	27	30	32	35	37	40	42	45	47	50	52	55	57	60	62	65	67	70	m
↕	↕ 12 t	↕ 6 t	↕										↕										
70	3,1 → 22,5 3,1 → 22,8	41,6 - 45 41,7 - 45,2	12	10,7	9,9	8,8	8,2	7,4	6,9	6,3	6	6	5,8	5,3	5	4,5	4,2	3,9	3,7	3,4	3,2	3	t
65	3,1 → 23,8 3,1 → 23,8	43,8 - 47,3 43,8 - 47,3	12	11,4	10,4	9,3	8,6	7,8	7,3	6,7	6,3	6	6	5,6	5,2	4,8	4,5	4,1	3,9	3,6	3,5	3,2	t P+
60	3,1 → 25,1 3,1 → 25,1	46,4 - 49,9 46,5 - 50	12	12	11,1	9,9	9,2	8,3	7,8	7,1	6,8	6,2	6	5,9	5,5	5	4,8	4,4	t				
55	3,1 → 24,4 3,1 → 24,4	45,2 - 48,5 45,2 - 48,5	12	11,7	10,8	9,6	8,9	8,1	7,6	6,9	6,5	6	6	5,8	5,6	5,2	t						
50	3,1 → 24,6 3,1 → 24,6	45,5 - 49 45,5 - 49	12	11,8	10,8	9,6	9	8,1	7,6	7	6,6	6,1	6	5,8	t								
45	3,1 → 25,5 3,1 → 25,5		12	12	11,3	10	9,3	8,4	7,9	7,2	6,9	6,3	t										
40	3,1 → 25,6 3,1 → 25,6		12	12	11,3	10	9,3	8,4	7,8	7,1	t												
35	3,1 → 25,7 3,1 → 25,7		12	12	11,3	10	9,3	8,4	t														
30	3,1 → 25,7 3,1 → 25,7		12	12	11,3	10	t																
25	3,1 → 24,9 3,1 → 24,9		12	11,9	t																		

↕ = ↕ - 0,65 t max.



↕ (m)			22	25	27	30	32	35	37	40	42	45	47	50	52	55	57	60	62	65	67	70	m
↕	↕ 12 t	↕ 6 t	↕										↕										
70	2,4 → 22,5 2,4 → 22,8	41,9 - 42,5 42 - 42,7	12	10,8	9,9	8,8	8,2	7,4	7	6,3	6	5,6	5,4	4,9	4,5	4,1	3,8	3,5	3,3	3	2,85	2,6	t
65	2,4 → 23,9 2,4 → 23,9	44,2 - 45 44,2 - 45	12	11,4	10,5	9,3	8,7	7,8	7,4	6,7	6,4	6	5,7	5,2	4,9	4,4	4,1	3,8	3,5	3,3	t		
60	2,4 → 25,2 2,4 → 25,2	46,7 - 48 46,9 - 48	12	12	11,1	9,9	9,2	8,4	7,9	7,2	6,8	6,3	6	5,6	5,2	4,7	4,5	4,1	t				
55	2,4 → 24,6 2,4 → 24,6	45,6 - 46,4 45,6 - 46,4	12	11,8	10,8	9,6	9	8,1	7,6	7	6,6	6,1	5,9	5,5	5,3	4,9	t						
50	2,4 → 24,7 2,4 → 24,7	45,9 - 47 45,9 - 47	12	11,8	10,9	9,7	9	8,2	7,7	7	6,6	6,1	6	5,5	t								
45	2,4 → 25,6 2,4 → 25,6		12	12	11,3	10,1	9,4	8,5	8	7,3	6,9	6,4	t										
40	2,4 → 25,7 2,4 → 25,7		12	12	11,3	10,1	9,3	8,4	7,9	7,2	t												
35	2,4 → 25,8 2,4 → 25,8		12	12	11,4	10,1	9,4	8,5	t														
30	2,4 → 25,8 2,4 → 25,8		12	12	11,4	10,1	t																
25	2,4 → 25 2,4 → 25		12	12	t																		

↕ = ↕ - 0,19 t max.



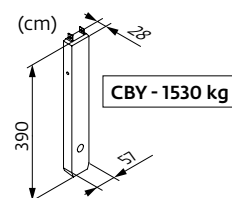
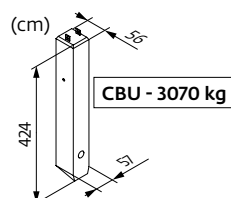
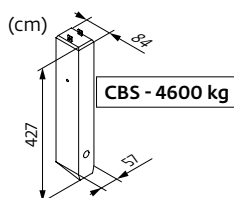

Poids de flèche & lest de contre-flèche / Auslegergewicht & Gegenauslegerballast / Jib weight & counter-jib ballast / Peso de flecha y lastre de contra-flecha/Peso del braccio & zavorra di contro-braccio/Peso da lança & lastro da contra lança/Вес стрелы и балласт контр-стрелы

↕	↕ (kg) (+/- 5%)			↕			↕		
	↕ 12 t	↕ 6 t	↕↔↕	4600 kg	1530 kg	↕ (kg)	3070 kg	1530 kg	↕ (kg)
70 m	14780	14400	14840	5	2	26060	8	1	26090
65 m	14475	14125	14570	5	2	26060	8	1	26090
60 m	14095	13770	14165	5	2	26060	8	1	26090
55 m	13250	12930	13320	5	0	23000	7	1	23020
50 m	13395	13070	13465	5	0	23000	7	1	23020
45 m	12655	12335	12725	4	2	21460	7	0	21490
40 m	12395	12070	12465	4	1	19930	6	1	19950
35 m	11585	11260	11655	4	0	18400	6	0	18420
30 m	10980	10660	11050	3	2	16860	5	1	16880
25 m	10065	9745	10135	3	1	15330	5	0	15350



Encombremet et poids / Abmessungen und Gewicht / Dimensions and weight / Dimensiones y peso / Ingombro e peso
dimensões e pesos / габаритные размеры и вес

Partie tournante / Drehender Kranteil / Slewing crane part / Parte giratoria

Parte rotante / Parte rotativa / Поворотная часть :  70 m -  -  -  50 LVF

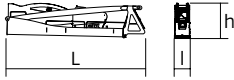
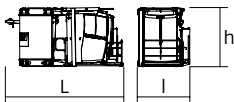
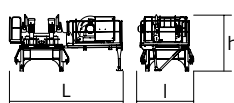
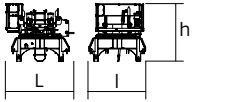
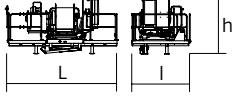
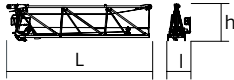
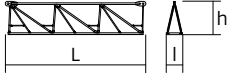
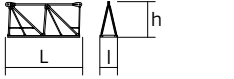
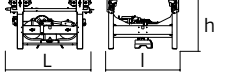
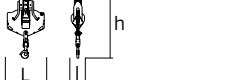
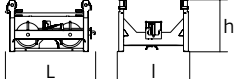
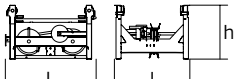
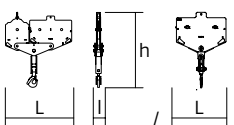

Partie tournante / Drehender Kranteil / Slewing crane part Parte giratoria / Parte rotante / Parte rotativa Поворотная часть		L (m)	l (m)	h (m)	kg (+/- 5%)
Contre-flèche / Gegenausleger Counter-jib / Contra-flecha Controbraccio / Contra-lança Контр-стрела		11 11	1,14 1,14	2,48 2,48	9900 9300
Mât-cabine + cabine / Kabinenmast + Kabine Cab mast + cab / Mástil-cabina + cabina Portaralla superiore + cabina / Tramo-cabina + cabina Секция мачты кабины + кабина		5,03	2,22	2,5	6000
Pivot + treuil de levage (+ câble) / Krankopf + Hubwerk (+ Seil) Towerhead + Hoisting winch (+ rope) Pivote + Mecanismo de elevación (+ cabo) Portaralla + Argano di sollevamento (+ fune) Pivot + Guincho de elevação (+ cabo) Секция поворотной части + Подъемная лебедка (+ канатом)		5,26	2,53	2,79	9550
Pivot / Krankopf Towerhead / Pivote Portaralla / Pivot Секция поворотной части		2,95	2,48	2,5	6000
Treuil de levage (+ câble) / Hubwerk (+ Seil) Hoisting winch (+ rope) / Mecanismo de elevación (+ cabo) Argano di sollevamento (+ fune) Guincho de elevação (+ cabo) Подъемная лебедка (+ канатом)		4,27	2,3	2,32	4500
Élément de flèche / Auslegerelement Jib section / Elemento de flecha Elemento di braccio / Elemento de lança Секция стрелы		10,91	1,72	2,74	4240
Élément de flèche / Auslegerelement Jib section / Elemento de flecha Elemento di braccio / Elemento de lança Секция стрелы		10,31 10,22 10,24 10,19	1,2 1,2 1,2 1,2	2,42 2,39 2,1 1,83	2420 1560 1235 795
Élément de flèche / Auslegerelement Jib section / Elemento de flecha Elemento di braccio / Elemento de lança Секция стрелы		5,36 5,27 5,09 5,09	1,2 1,2 1,2 1,2	2,45 2,39 1,53 1,39	1435 960 310 220
Chariot / Laufkatze Trolley / Carrello Carro / Carro-distribuidor Тележка		1,87	1,51	1,05	400
Moufle / Hubflasche Pulley block / Aparejo Bozzello / Cadernal Полиспаст		1,19	0,43	2,31	455
Chariot / Laufkatze Trolley / Carrello Carro / Carro-distribuidor Тележка		1,57	1,51	0,98	210
Chariot / Laufkatze Trolley / Carrello Carro / Carro-distribuidor Тележка		1,7 1,86	1,51 1,51	1,03 0,98	245 236
Moufle / Hubflasche Pulley block / Aparejo Bozzello / Cadernal Полиспаст		1,65 1,09	0,22 0,27	1,78 1,62	450 265

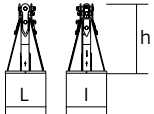
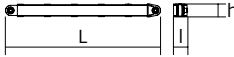
Рулоне / Kranturm / Crane tower Mástil / Torre / Torre Башня крана		L (m)	I (m)	h (m)	kg (+/- 5%)	
T 61		10,83	4,14	4,47	9700	
K 649B KM 649E KRM 6410B		10,23 10,29 10,23	2,07 2,03 2,1	2,03 2,03 2,08	5290 4850 7100	
KR 649A KRMT 649A K 649A KMT 649A		5,23 5,23 5,23 5,23	2,1 2,1 2,07 2,07	2,08 2,08 2,03 2,03	3250 3050 2805 2570	
KRMT 649C		3,57	2,1	2,08	2450	
Pieds de scellement / VerankerungsfüÙe Fixing angles / Pie de empotramiento Montante da anegare / Angulos fixadores анкера		P 63A / P 800B	0,75	0,75	1,28	465
Mât-châssis / Grundmasteinheit Basic mast unit / Tramo-chasis Elemento base / Tramo-chassis Мачта для крепления к шасси		V 60A V 63A	5,01 10,02	2,41 2,41	2,41 2,41	4760 7660
Haubans / Mastabstützungen Struts / Tornapuntas Puntoni / Escoras Растяжка		V 60A V 63A	4,51 4,51	0,29 0,33	0,29 0,33	470 560
Sommier / Unterwagenhälfte Half-bearer / Testero Testata / Estrutura base Траверса		V 60A V 63A	6,7 6,7	0,7 0,7	2,31 2,31	1840 1860
Bras de croix / Fundamentkruzträger Cross girder / Brazo en cruz Braccio croce / Braço da cruz Поперечная балка		ZD 640	6,77	0,3	1,42	3200
1/2 Bras de croix / 1/2 Fundamentkruzträger 1/2 Cross girder / 1/2 Brazo en cruz 1/2 Braccio croce / 1/2 Braço da cruz 1/2 Поперечная балка		ZD 640	3,28	0,59	1,42	1350
Bras de croix / Fundamentkruzträger Cross girder / Brazo en cruz / Braccio croce / Braço da cruz Поперечная балка		ZX 640	9,15	1,19	1,56	6880
1/2 Bras de croix / 1/2 Fundamentkruzträger 1/2 Cross girder / 1/2 Brazo en cruz 1/2 Braccio croce / 1/2 Braço da cruz 1/2 Поперечная балка		ZX 640	4,35	1	1,56	3320

400 V - 50 Hz 480 V - 60 Hz											ch - PS hp	kW			
	400 V - 50 Hz 480 V - 60 Hz	50 LVF 30 Optima	m/min t	32 6	40 4,5	52,5 3	67,5 1,5	16,5 12	21 9	27,5 6	33,5 3,2	50	37	337 m	
	400 V - 50 Hz	75 HPL™ 30	m/min t	44 6	57,5 4,5	82 3	140 1,5	220,5 0,2	23 12	30 9	43,5 6	74 3	110 0,8		845 m
	480 V - 60 Hz	90 HPL™ 30	m/min t	53,5 6	69,5 4,5	99,5 3	143 1,5	220,5 0,2	27,5 12	36,5 9	52,5 6	74,5 3	110 0,8		
		6 DVF 4 Optima	m/min	0 → 50 (12 t) 0 → 100 (6 t) 0 → 120 (3 t)				5,5	4	m/min					
	400 V - 50 Hz 480 V - 60 Hz	RVF 162 Optima+	tr/min U/min rpm	400 V - 50 Hz : 0 → 0,8 480 V - 60 Hz : 0 → 0,9				2 x 7,5	2 x 5,5						

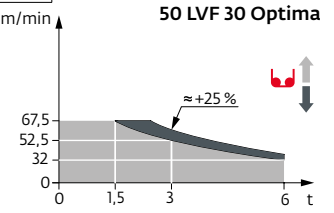

	IEC 60204-32	
400 V (+10% -10%) 50 Hz	50 LVF : 58 → 38 kVA 75 HPL™ : 78 → 48 kVA	
480 V (+6% -10%) 60 Hz	50 LVF : 58 → 38 kVA 90 HPL™ : 90 → 54 kVA	

	FR	DE	EN	ES	IT	PT	RU
	Appel de flèche	Auslegerüberhöhung	Jib elevation	Elevación de la flecha	Inclinazione braccio	Desvio da lança	подъем стрелы
	Équipements standards	Standardausrüstungen	Standard equipment	Equipamiento de serie	Equipaggiamento standard	Equipamento de série	Стандартное оборудование
	Équipements optionnels	Sonderausrüstungen	Options	Equipamiento opcional	Equipaggiamento in opzione	Equipamento opcional	Дополнительное оборудование (опция)
	Fonction Potain Plus : Courbes de charges Plus	Funktion Potain Plus: Plus-Lastkurven	Potain Plus function: Plus load curves	Función Potain Plus: Diagrama de cargas Plus	Funzione Potain PLUS: Curve di carico Plus	Função Potain Plus: Diagrama de cargas Plus	Функция контроля мощности Potain Plus: Диаграммы грузоподъемности Plus
	Hauteurs sous crochet associées aux courbes de charges Plus	Hakenhöhen mit Plus-Lastkurven	Hook heights with Plus load curves	Altura bajo gancho, usando el diagrama de cargas Plus	Altezze sotto gancio con curve di carico Plus	Altura livre, utilizando o diagrama de cargas Plus	Высота под крюком для диаграмм грузоподъемности Plus
	Réactions en service	Reaktionskräfte in Betrieb	Reactions in service	Reacciones en servicio	Reazioni in servizio	Reações em serviço	Реакция при работе
	Réactions hors service	Reaktionskräfte außer Betrieb	Reactions out of service	Reacciones fuera de servicio	Reazioni fuori servizio	Reações fora de serviço	Реакция в покое
	Poids total du lest	Ballast-Gesamtgewicht	Total ballast weight	Peso total del lastre	Peso totale della zavorra	Peso total do lastro	Общий вес балласта
	Cadre d'ancrage serré	Fester Verankerungsrahmen	Tightened anchorage frame	Marco de anclaje de apriete	Quadro di ancoraggio stretto	Quadro de amarração apertado	Прикрепленная анкерная рама
	Cadre d'ancrage desserré	Loser Verankerungsrahmen	Loosened anchorage frame	Marco de anclaje de desapriete	Quadro di ancoraggio allentato	Quadro de amarração solto	Отсоединенная анкерная рама
	Poids de flèche	Auslegergewicht	Jib weight	Peso de flecha	Peso del braccio	Peso da lança	вес стрелы
	Camion 13,4 m	Lkw 13,4 m	Lorry 13,4 m	Camión 13,4 m	Camion 13,4 m	Camião 13,4 m	Ррузовой автомобиль 13,4 м
	Conteneur High Cube 40', et/ou Flat Rack 20'	Container High Cube 40', und/oder Flat Rack 20'	Container High Cube 40', and/or Flat Rack 20'	Contenedor High Cube 40', y/o Flat Rack 20'	Container High Cube 40', e/o Flat Rack 20'	Contentor High Cube 40', e/ou Flat Rack 20'	40-футовый контейнер повышенной вместимости High Cube, и/или 20-футовая открытая платформа Flat Rack
	Levage	Heben	Hoisting	Elevación	Sollevamento	Elevação	Подъем
	Distribution	Katzfahren	Trolleying	Distribución	Distribuzione	Distribuição	Перемещение по стреле
	Orientation	Schwenken	Slewing	Orientación	Rotazione	Rotação	Поворот
	Translation	Kranfahren	Travelling	Traslación	Traslazione	Translação	Перемещение крана
	Puissance requise	Erforderliche Leistung	Required power	Potencia Necesaria	Potenza richiesta	Potência Necessária	Потребляемая мощность
	Fonction Power Control : vitesses treuils adaptées à la puissance disponible	Funktion Power Control: Geschwindigkeiten der Triebwerke werden an die verfügbare Leistung angepasst	Power Control Function: winch speeds adapted to the available power	Función Power Control: marchas de los cabrestantes adaptadas a la potencia disponible	Funzione Power Control: velocità degli argani adattate alla potenza disponibile	Função Power Control: velocidades de guincho adaptadas à potência disponível	Функция контроля мощности Power Control: регулировка скорости лебедок в зависимости от доступной мощности
	Nous consulter	Auf Anfrage	Consult us	Consultarnos	Consultateci	Consultar-nos	Проконсультируйтесь у нас
	Document commercial non contractuel. Pour toute information technique se référer à la notice correspondante.	Unverbindliches Vertriebsdokument. Für technische Informationen, siehe die entsprechenden Anweisungen.	This commercial document is not legally binding. For any technical information, please refer to the corresponding instructions.	Documento comercial no contractual. Para cualquier información técnica, ver la noticia correspondiente.	Documento commerciale non vincolante, per tutte le informazioni tecniche fare riferimento al catalogo istruzioni.	Documento comercial não contratual. Para qualquer informação técnica complementar consultar as respectivas instruções.	Этот коммерческий документ не является юридически обязательным. Для получения технической информации, см. соответствующие инструкции.

