

# Potain MR 415 H24

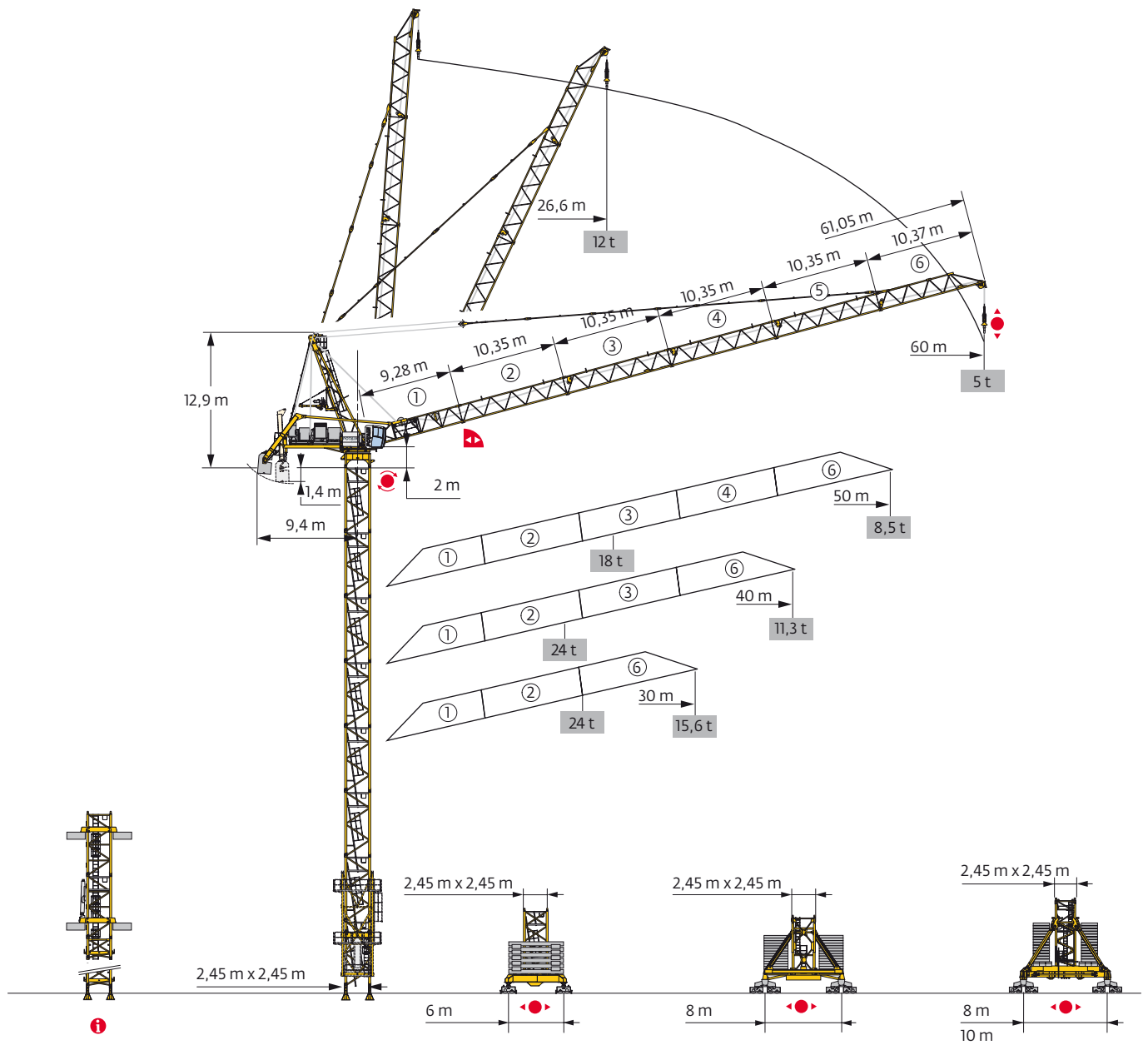

Mât - Réactions / Mast - Reaktionskräfte / Mast - Reactions / Mástil - Reacciones / Torre - Reazioni  
 Tramo - Reações / Реакция опор мачты

2,45 m

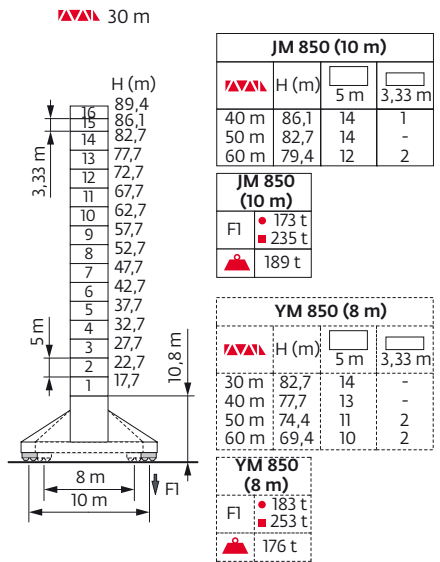
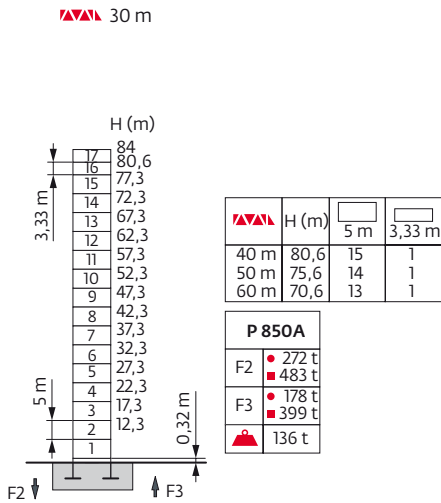
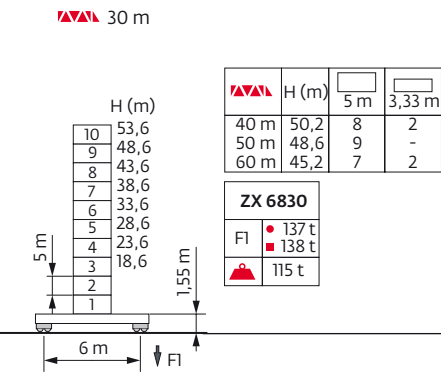
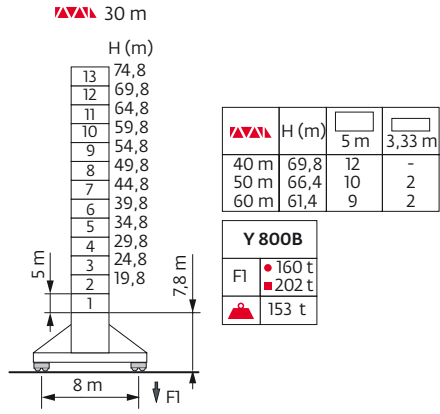
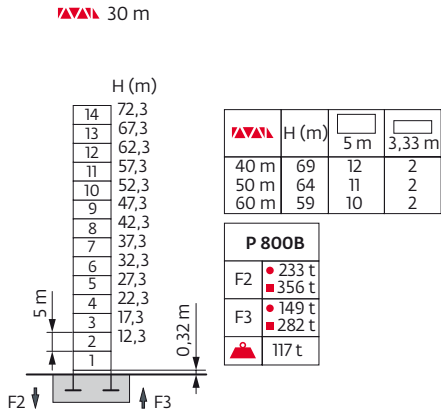

Y 800B	H1 = H	H2 = H - 0,8 m	H3 = H - 1,2 m
YM 850 - JM 850	H1 = H	-	H3 = H - 1,4 m
ZX 6830	H1 = H	-	H3 = H - 0,3 m

Anchages / Verankerungen / Anchorages / Anclajes / Ancoraggi  
 Ancoragem / Анкера

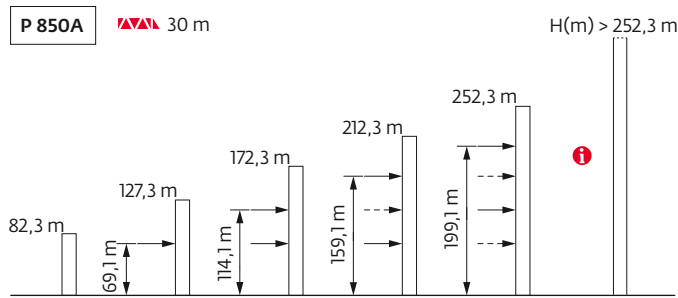
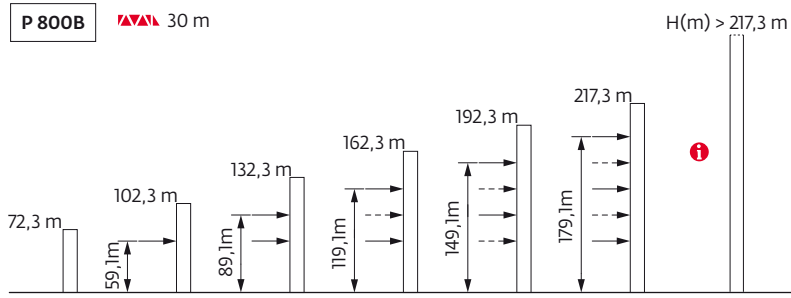

Courbes de charges / Lastkurven / Load curves / Curvas de cargas / Curve di carico  
 Curvas de carga / Кривые нагрузок

60 m	5,9	▶					26,6	28	30	35	40	45	50	55	60	m																				
▲▼▲	↓								12	11,4	10,6	9	7,8	6,9	6,1	5,5	5	t																		
50 m	5,2	▶					23,6	24	25	26	28	30	35	36,1	40	45	50	m																		
▲▼▲	↓								18	17,7	17	16,3	15	13,9	11,8	-	10,2	8,9	7,9	t																
	↓													12	10,8	9,5	8,5		t																	
40 m	4,4	▶	18,8	20	22	24	25	26	28	30	35	37,8	40							m																
▲▼▲	↓													24	22,5	20,4	18,6	17,8	17,1	15,8	14,6	12,4	-	10,7		t										
	↓																							12	11,3		t									
30 m	3,7	▶																									m									
▲▼▲	↓																										24	21,7	19,8	19	18,2	16,8	15,6		t	
	↓																																	12		t

Lest de base / Grundballast / Base ballast / Lastre de base / Zavorra di base  
 Lastro da base / Базовый Балласт

		2,45 m							
		Y 800B		ZX 6830		YM 850		JM 850	
	H (m)	☐ (t)	H (m)	☐ (t)	H (m)	☐ (t)	H (m)	☐ (t)	
30 m	74,8	180	53,6	121	82,7	216	89,4	204	
40 m	69,8	168	50,2	121	77,7	204	86,1	204	
50 m	66,4	180	48,6	141	74,4	216	82,7	204	
60 m	61,4	180	45,2	161	69,4	216	79,4	216	

Lest de contre-flèche / Gegenauslegerballast / Counter-jib ballast / Lastre de contra-flecha / Zavorra di controbraccio  
 Lastro da contra lança / Противовес стрелы

	4400 kg	☐ (kg)
30 m	7	30800
40 m	8	35200
50 m	9	39600
60 m	9	39600

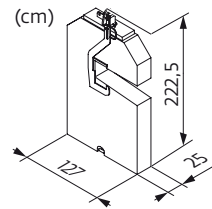

4400 kg

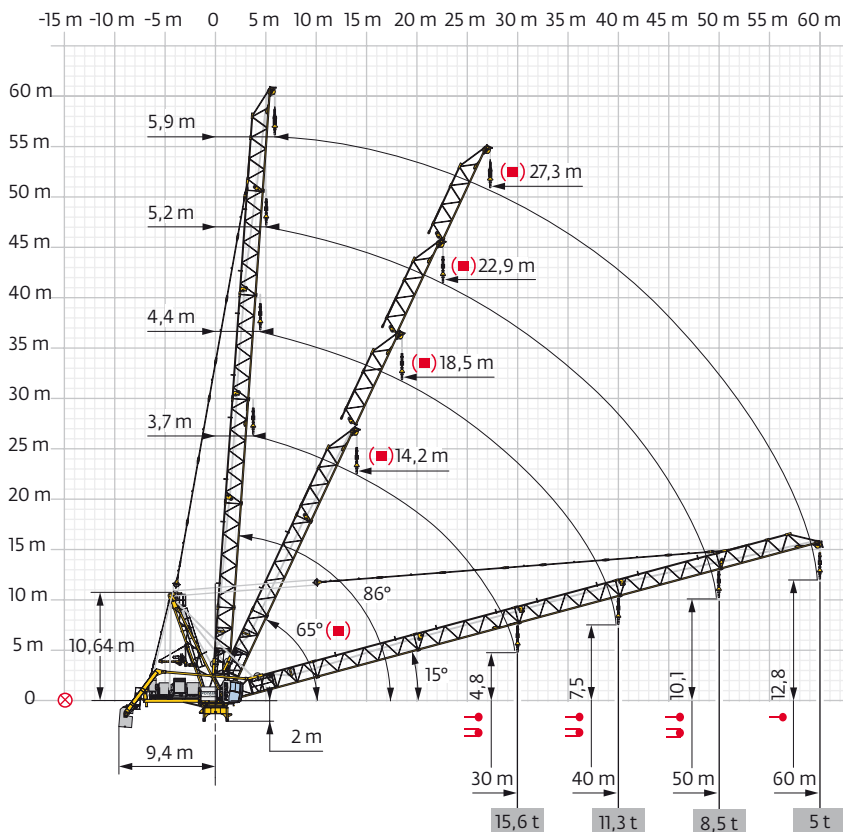

Flèche relevée / Ausleger in Steilstellung / Luffing jib / Flecha izada / Braccio impennato  
 Lança inclinada / Маховая стрела







Encombremet et poids / Abmessungen und Gewicht / Dimensions and weight / Dimensiones y peso / Ingombro e peso  
dimensões e pesos / габаритные размеры и вес

Partie tournante / Drehender Kranteil / Slewing crane part / Parte giratoria  
Parte rotante / Parte rotativa / Поворотная часть :  60 m -  180/215 LBR

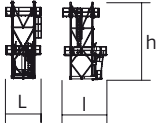
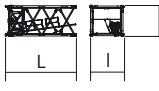
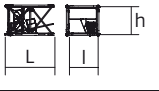
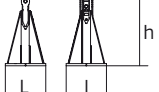
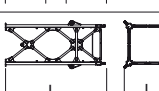
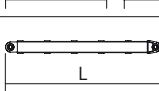
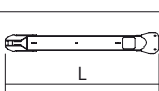
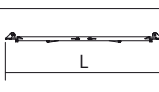
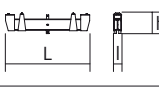
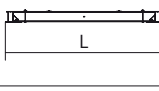
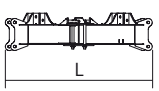

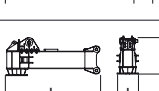
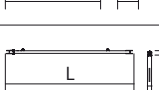
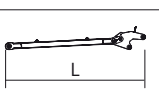
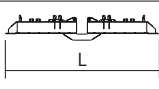
Partie tournante / Drehender Kranteil / Slewing crane part Parte giratoria / Parte rotante / Parte rotativa Поворотная часть	L (m)	I (m)	h (m)	kg (+/- 5%)
Contre-flèche / Gegenausleger Counter-jib / Contra-flecha Controbraccio / Contra-lança Контр-стрела				
Poinçon / Auslegerhaltebock Strut / Puntal Puntone / Extrator стойка				
Cabine / Kabine Cab / Cabina Cabina / Cabina Кабина			Ultra View	
Pivot / Krankopf Towerhead / Pivote Portaralla / Pivot Секция поворотной части			$\nabla$ 2,45 m	
Elément de flèche / Auslegerelement Jib section / Elemento de flecha Elemento di braccio / Elemento de lança Секция стрелы			①	
Elément de flèche / Auslegerelement Jib section / Elemento de flecha Elemento di braccio / Elemento de lança Секция стрелы			②	9,7
			③	10,53
			④	10,53
			⑤	10,53
Elément de flèche / Auslegerelement Jib section / Elemento de flecha Elemento di braccio / Elemento de lança Секция стрелы			⑥	
Moufle / Hubflasche Pulley block / Aparejo Bozzello / Cadernal Полиспаст				
Treuil de levage (+ câble) / Hubwerk (+ Seil) Hoisting winch (+ rope) / Mecanismo de elevación (+ cabo) Argano di sollevamento (+ fune) Guincho de elevação (+ cabo) Подъемная лебедка (+ канатом)			180/215 LBR	
Treuil de levage (+ câble) / Auslegerverstellwerk (+ Seil) Luffing winch (+ rope) / Mecanismo de izado (+ cabo) Argano di Impennaggio braccio (+ fune) Mecanismo de Inclinação da Lança (+ cabo) лебедка подъема стрелы (+ канатом)			124/150 VBR	

<b>Pyłóne / Kranturm / Crane tower</b> <b>Mástil / Torre / Torre</b> <b>Башня крана</b>		<b>L (m)</b>	<b>I (m)</b>	<b>h (m)</b>	<b>kg</b> (+/- 5%)	
Cage de télescopage / Teleskopwagen Telescopic cage / Jaula de telescopaje Gabbia di telescopaggio / Gaiola de telescopagem для телескопирования крана		∇2,45 m	4,62	5,79	10,23	12920
K 850/KR 849A KRMT 849A K 849A KMT 850.10A		∇2,45 m	5,24 5,23 5,23 5,32	2,54 2,55 2,53 2,54	2,5 2,53 2,5 2,51	5575 4090 3400 5450
KRMT 849C		∇2,45 m	3,57	2,55	2,53	3205
Pieds de scellement / VerankerungsfüÙe Fixing angles / Pie de empotramiento Montante da annegare / Angulos fixadores анкера		P 800B P 850A	0,75 0,9	0,75 0,9	1,28 1,49	465 835
Mât-châssis / Grundmasteinheit Basic mast unit / Tramo-chasis Elemento base / Tramo-chassis Мачта для крепления к шасси		Y 800B	6,03	2,93	2,93	8620
Haubans / Mastabstüzungen Struts / Tornapuntas Puntoni / Escoras Растяжка		Y 800B	5,51	0,5	0,45	1110
1/2 Longeron / 1/2 Långsträger 1/2 Side member / 1/2 Larguero 1/2 Longherone / 1/2 Longarina 1/2 боковина		Y 800B	5,68	1,24	0,73	1520
Longeron / Långsträger Side member / Larguero Longherone / Longarina боковина		Y 800B	12	1,24	0,73	3050
Support lest / Ballsträger Ballast support / Soporte de lastre Supporto zavorra / Suporte de lastro Опора балласта		Y 800B	3,75	0,37	0,92	1085
Traverse de châssis / Unterwagentraverse Chassis beam / Traviesa chasis Traversa carro / Travessa chassis балка шасси		Y 800B	8,7	0,83	0,74	2240
Croix centrale (position transport) / Zentralkreuz (Transport- position) / Central cross (transport position) / Brazo central (posición transporte) / Croce centrale (posizione di trasporto) Brazo central chassis (posição transporte) / крестообразное основание (транспортное положение)		YM 850 JM 850	5,2	1,7	1,5	6700
Mât-châssis / Grundmasteinheit Basic mast unit / Tramo-chasis Elemento base / Tramo-chassis Мачта для крепления к шасси		YM 850 JM 850	8,75	2,5	2,5	14600
Bras de châssis / Unterwagenträger / Chassis girder / Brazo de base en cruz / Traverse del carro / Braço de chassis / опорная балка шасси		YM 850 JM 850	3,8 5,2	0,9 0,9	1,55 1,55	2800 3200
Tirant de châssis / Unterwagenstreben / Chassis ties / Tirante de base en cruz / Tiranti del carro / Tirante de chassis / тяга крепления шасси		YM 850 JM 850	7,2	0,25	0,35	250
Haubans / Mastabstüzungen Struts / Tornapuntas Puntoni / Escoras Растяжка		YM 850 JM 850	7,5 8,2	0,75 0,75	1,3 1,3	2100 2300
Bras de croix / Fundamentkreuzträger Cross girder / Brazo en cruz Braccio croce / Braço da cruz Поперечная балка		ZX 6830	9,1	0,76	1,48	5445
Bras de croix / Fundamentkreuzträger Cross girder / Brazo en cruz Braccio croce / Braço da cruz Поперечная балка		ZX 6830	9,1	1,12	1,1	5265



















Mécanismes / Triebwerke / Mechanisms / Mecanismos / Meccanismi  
 Mecanismos / Механизмы

400 V - 50 Hz											ch - PS hp	kW	
	180 LBR 120	m/min t	5,3/53 12	8,4/84 7,3	13,5/135 4,3	21,4/214 2,35	2,6/26 24	4,2/42 15	6,7/67 8,9	10,7/107 5	180	132	580 m
	124 VBR		1 min 31 s								125	90	
	R - 8,8	tr/min U/min rpm	0 → 0,67								2 x 6	2 x 4,4	
	Y 800B RT 584 A1 - 2V	m/min	7 - 14								8 x 7	8 x 5,2	
	ZX 6830 RT 664 A2B - 2V	m/min	16 - 32								6 x 7	6 x 5,2	
	YM 850 JM 850												

	IEC 60204-32		kVA
	400 V (+10% -10%) 50 Hz		180 LBR : 240 kVA

480 V - 60 Hz											ch - PS hp	kW	
	215 LBR 120	m/min t	6,3/63 12	10/100 7,3	16/162 4,3	25/256 2,35	3,1/31 24	5/50 15	8/81 8,9	13/128 5	215	158	580 m
	150 VBR		1 min 16 s								148	108	
	R - 10,5	tr/min U/min rpm	0 → 0,8								2 x 7,2	2 x 5,3	
	Y 800B RT 584 A1 - 2V	m/min	8,5 - 17								8 x 8,4	8 x 6,2	
	ZX 6830 RT 664 A2B - 2V	m/min	19 - 38								6 x 8,4	6 x 6,2	
	YM 850 JM 850												

	IEC 60204-32		kVA
	480 V (+6% -10%) 60 Hz		215 LBR : 280 kVA

	FR	DE	EN	ES	IT	PT	RU
	Équipements standards	Standardausrüstungen	Standard equipment	Equipamiento de serie	Equipaggiamento standard	Equipamento de série	Стандартное оборудование
	Équipements optionnels	Sonderausrüstungen	Options	Equipamiento opcional	Equipaggiamento in opzione	Equipamento opcional	Дополнительное оборудование (опция)
	Réactions en service	Reaktionskräfte in Betrieb	Reactions in service	Reacciones en servicio	Reazioni in servizio	Reacções em serviço	Реакция при работе
	Réactions hors service	Reaktionskräfte außer Betrieb	Reactions out of service	Reacciones fuera de servicio	Reazioni fuori servizio	Reacções fora de serviço	Реакция в покое
	Poids à vide sans lest avec flèche et hauteur maximum	Gewicht ohne Last, ohne Ballast, mit Ausleger und max. Höhe	Weight without load, without ballast, with jib and max. height	Peso en vacío sin lastre, con flecha y altura máxima	Peso a vuoto, senza zavorra, con braccio e altezza massimi.	Peso em vazio sem lastro com lança e altura máxima.	Вес пустого, без балласта, со стрелой, максимальной высоты.
	Poids total du lest	Ballast-Gesamtgewicht	Total ballast weight	Peso total del lastre	Peso totale della zavorra	Peso total do lastro	Общий вес балласта
	Axe articulation flèche	Auslegergelenk-achse	Jib articulation axis	Eje de articulación de la flecha	Perno di articolazione del braccio	Eixo de articulação da lança	Ось шарнира стрелы
	Position girouette	Windfreistellung	Weather vane position	Posición veleta	Libera rotazione	Posição em cata-vento	Флюгер
	Camion 13,4 m	Lkw 13,4 m	Lorry 13,4 m	Camión 13,4 m	Camion 13,4 m	Camião 13,4 m	Ррузовой автомобиль 13,4 м
	Conteneur High Cube 40', et/ou Flat Rack 20'	Container High Cube 40', und/oder Flat Rack 20'	Container High Cube 40', and/or Flat Rack 20'	Contenedor High Cube 40', y/o Flat Rack 20'	Container High Cube 40', e/o Flat Rack 20'	Contentor High Cube 40' e/ou Flat Rack 20'	40-футовый контейнер повышенной вместимости High Cube, и/или 20-футовая открытая платформа Flat Rack
	Cadre d'ancrage serré	Fester Verankerungsrahmen	Tightened anchorage frame	Marco de anclaje de apriete	Quadro di ancoraggio stretto	Quadro de amarração apertado	Прикрепленная анкерная рама
	Cadre d'ancrage desserré	Looser Verankerungsrahmen	Loosened anchorage frame	Marco de anclaje de desapriete	Quadro di ancoraggio allentato	Quadro de amarração solto	Отсоединенная анкерная рама
	Levage	Heben	Hoisting	Elevación	Sollevamento	Elevação	Подъем
	Relevage	AL-Verstellen	Luffing	Izado	Brandeggio	Levantamento	Маховый подъем
	Orientation	Schwenken	Slewing	Orientación	Rotazione	Rotação	Поворот
	Translation	Kranfahren	Travelling	Traslación	Traslazione	Translação	Перемещение крана
	Puissance requise	Erforderliche Leistung	Required power	Potencia Necesaria	Potenza richiesta	Potência Necessária	Потребляемая мощность
	Nous consulter	Auf Anfrage	Consult us	Consultarnos	Consultateci	Consultar-nos	Проконсультируйтесь у нас
	Document commercial non contractuel. Pour toute information technique se référer à la notice correspondante.	Unverbindliches Vertriebsdokument. Für technische Informationen, siehe die entsprechenden Anweisungen.	This commercial document is not legally binding. For any technical information, please refer to the corresponding instructions.	Documento comercial no contractual. Para cualquier información técnica, ver la noticia correspondiente.	Documento commerciale non vincolante, per tutte le informazioni tecniche fare riferimento al catalogo istruzioni.	Documento comercial não contratual. Para qualquer informação técnica complementar consultar as respectivas instruções.	Этот коммерческий документ не является юридически обязательным. Для получения технической информации, см. соответствующие инструкции.

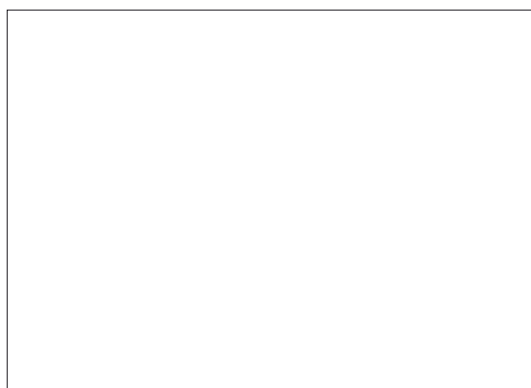

**Americas**  
**Manitowoc, Wisconsin, USA**  
 Tel: +1 920 684 6621  
 Fax: +1 920 683 6277

**Shady Grove, Pennsylvania, USA**  
 Tel: +1 717 597 8121  
 Fax: +1 717 597 4062

[www.manitowoc.com](http://www.manitowoc.com)

**Europe, Middle East, Africa**  
**Ecully, France**  
 Tel: +33 (0)4 72 18 20 20  
 Fax: +33 (0)4 72 18 20 00

**China**  
**Shanghai, China**  
 Tel: +86 21 6457 0066  
 Fax: +86 21 6457 4955

**Greater Asia-Pacific**  
**Singapore**  
 Tel: +65 6264 1188  
 Fax: +65 6862 4040