

MR 90 C

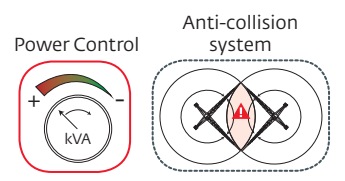

Mât - Réactions / Mast - Reaktionskräfte / Mast - Reactions / Mástil - Reacciones / Torre - Reazioni
 Tramo - Reações / Реакция опор мачты

1,6 m

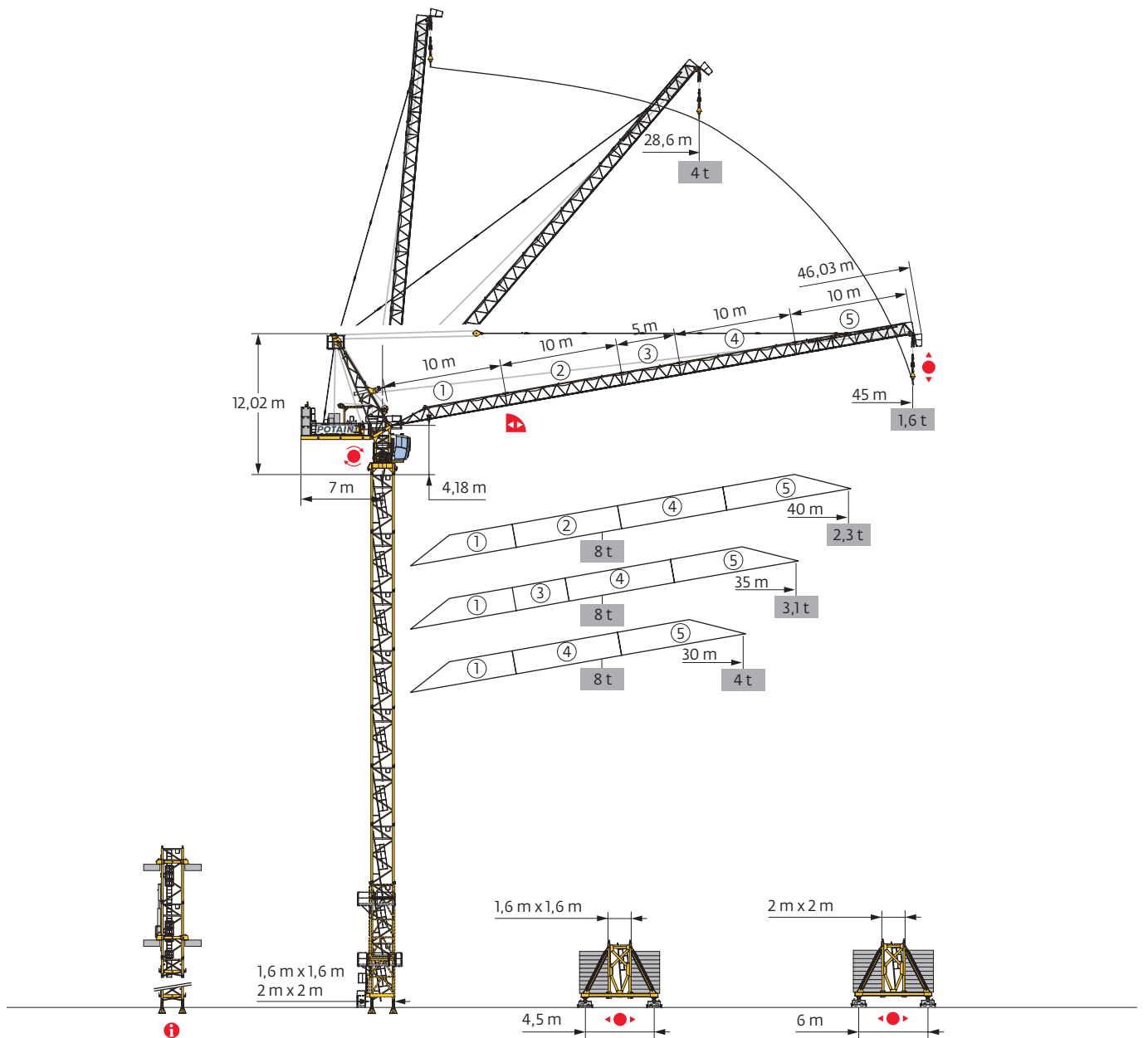
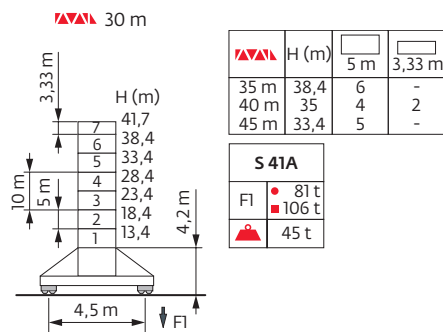
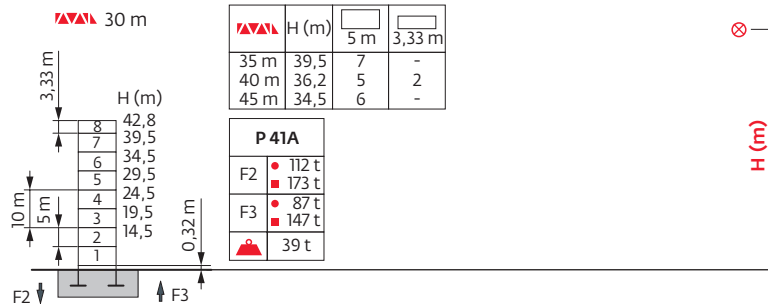

2 m

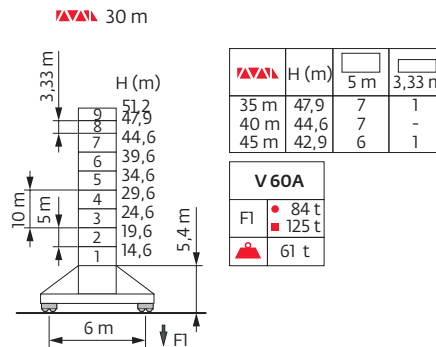
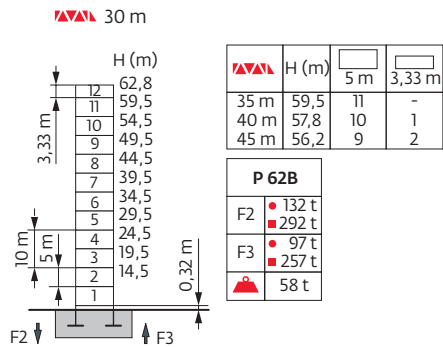

S 41A



H1 = H



H2 = H - 0,3 m



H3 = H - 0,7 m

V 60A



H1 = H



H2 = H - 0,4 m



H3 = H - 0,8 m

i Accès motorisés : compositions de mâture, de lest de base et réactions adaptées. / Motorisierter Zugang vom : Mastzusammensetzung, Grundballast und Reaktionskräfte sind angepasst. / Motorized accesses: adapted mast composition, base ballast and reactions. / Acceso a cabina con elevador: Adaptación de composición de mástil, lastre de base y reacciones. / Accessi motorizzati: composizioni elementi torre, zavorre di base e reazioni aggiornate. / Acessos motorizados: composições de coluna, lastro da base e reações adaptadas. / Лифты : адаптированная композиция мачты, базовый балласт и нагрузки.

Lest de base / Grundballast / Base ballast / Lastre de base / Zavorra di base
 Lastro da base / Базовый Балласт

	□ 1,6 m		□ 2 m	
	◀●▶ S 41A		◀●▶ V 60A	
▲▲▲▲	H (m)	▲▲ (t)	H (m)	▲▲ (t)
30 m	41,7	126	51,2	132
35 m	38,4	126	47,9	132
40 m	35	126	44,6	132
45 m	33,4	126	42,9	132

Poids de flèche & lest de contre-flèche / Auslegergewicht & Gegenauslegerballast / Jib weight & counter-jib ballast / Peso de flecha y lastre de contra-flecha / Peso del braccio & zavorra di contro-braccio / Peso da lança & lastro da contra lança
 Вес стрелы и балласт контр-стрелы

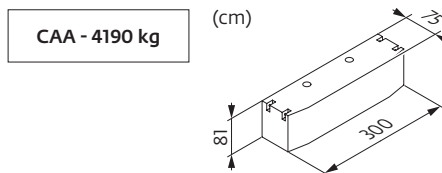

▲▲▲▲	▲▲▲▲ (kg) (+/- 5%)		▲▲ (kg)	
	▲▲	▲▲ ▲▲	4190 kg	▲▲ (kg)
30 m	2765	2965	3	12570
35 m	3175	3375	3	12570
40 m	3535	3735	3	12570
45 m	3920	-	3	12570

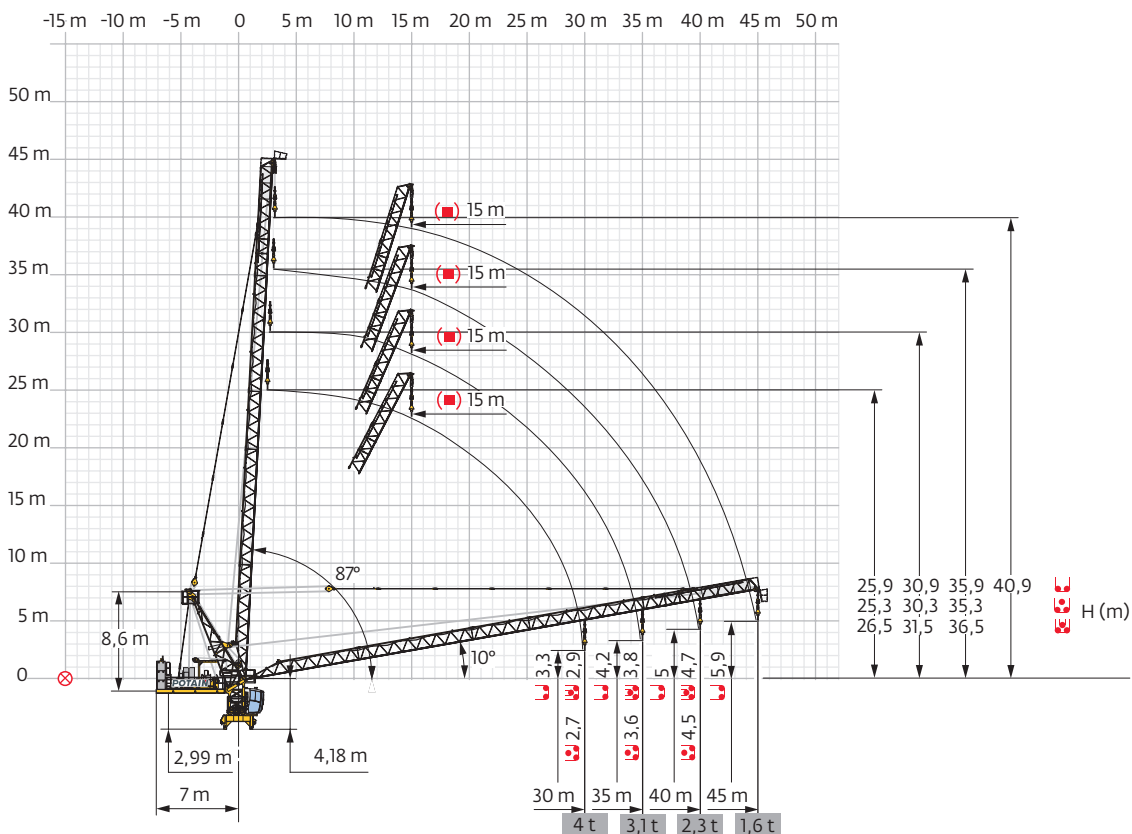

Flèche relevée / Ausleger in Steilstellung / Luffing jib / Flecha izada / Braccio impennato
 Lança inclinada / Маховая стрела



Encombremet et poids / Abmessungen und Gewicht / Dimensions and weight / Dimensiones y peso / Ingombro e peso
dimensões e pesos / габаритные размеры и вес

Partie tournante / Drehender Kranteil / Slewing crane part / Parte giratoria
Parte rotante / Parte rotativa / Поворотная часть :  45 m -  33 LVF

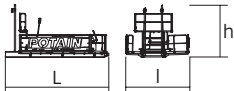
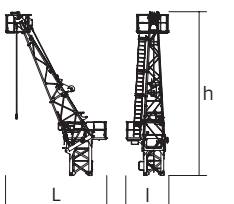
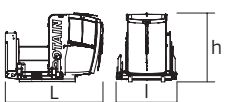
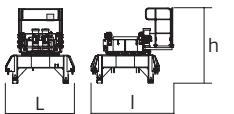
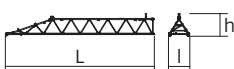
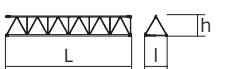
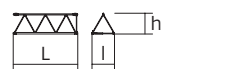
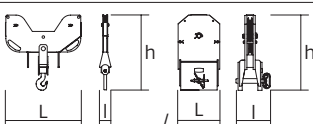
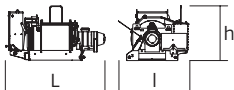
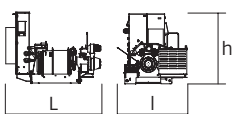

Partie tournante / Drehender Kranteil / Slewing crane part Parte giratoria / Parte rotante / Parte rotativa Поворотная часть		L (m)	l (m)	h (m)	kg (+/- 5%)	
Contre-flèche / Gegenausleger Counter-jib / Contra-flecha Controbraccio / Contra-lança Контр-стрела		6,15	3,94	3,21	2220	
Poinçon / Auslegerhaltebock Strut / Puntal Puntone / Extrator стойка		6,44	2,67	10,45	4670	
Cabine / Kabine Cab / Cabina Cabina / Cabina Кабина		Ultra View	3,56	2,21	2,51	1550
Pivot / Krankopf Towerhead / Pivote Portaralla / Pivot Секция поворотной части		∇ 1,6 m ∇ 2 m	2,1 2,48	2,78 2,98	2,7 2,7	3615 4430
Elément de flèche / Auslegerelement Jib section / Elemento de flecha Elemento di braccio / Elemento de lança Секция стрелы		①	10,15	1,53	1,45	735
Elément de flèche / Auslegerelement Jib section / Elemento de flecha Elemento di braccio / Elemento de lança Секция стрелы		②	10,1	1,16	1,38	650
		④	10,1	1,16	1,38	675
Elément de flèche / Auslegerelement Jib section / Elemento de flecha Elemento di braccio / Elemento de lança Секция стрелы		③	5,1	1,16	1,38	360
		⑤	10,08	1,47	1,35	690
Moufle / Hubflasche Pulley block / Aparejo Bozzello / Cadernal Полиспаст		1,42 0,4	0,22 0,28	1,2 0,73	290 160	
Treuil de levage (+ câble) / Hubwerk (+ Seil) Hoisting winch (+ rope) / Mecanismo de elevación (+ cabo) Argano di sollevamento (+ fune) Guincho de elevação (+ cabo) Подъемная лебедка (+ канатом)		33 LVF	2,18	1,54	1,63	1555
		50 LVF	2,29	1,51	1,63	2145
Treuil de levage (+ câble) / Auslegerverstellwerk (+ Seil) Luffing winch (+ rope) / Mecanismo de izado (+ cabo) Argano di Impennaggio braccio (+ fune) Mecanismo de Inclinação da Lança (+ cabo) лебедка подъема стрелы (+ канатом)		50 VVF	2,55	1,72	1,87	1890

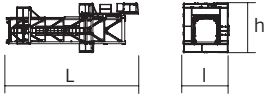
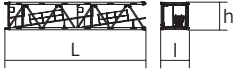
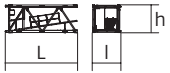
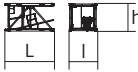
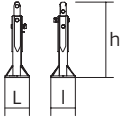
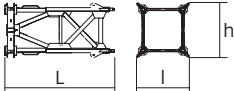
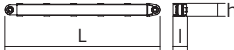
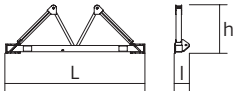
Рyл6не / Kranturm / Crane tower Mástil / Torre / Torre Башня крана		L (m)	l (m)	h (m)	kg (+/- 5%)	
T41 T61		1,6 m 2 m	10,85 10,83	3,73 4,14	4,1 4,47	7100 9700
K 447E KM 447E KM 449E K 649B KM 649E		1,6 m 1,6 m 1,6 m 2 m 2 m	10,21 10,21 10,21 10,23 10,29	1,62 1,62 1,62 2,07 2,03	1,62 1,62 1,62 2,03 2,03	3390 3215 3830 5290 4850
K 447A KMT 447A K 449A KMT 449A K 649A KMT 649A KR 649A KRMT 649A		1,6 m 1,6 m 1,6 m 1,6 m 2 m 2 m 2 m 2 m	5,21 5,21 5,21 5,21 5,23 5,23 5,23 5,23	1,67 1,67 1,67 1,67 2,07 2,07 2,1 2,1	1,62 1,62 1,62 1,62 2,03 2,03 2,08 2,08	1850 1745 2230 2130 2805 2570 3250 3050
K 447C K 649C KRMT 649C		1,6 m 2 m 2 m	3,45 3,57 3,57	1,67 2,07 2,1	1,62 2,03 2,08	1360 1985 2450
Pieds de scellement / Verankerungsfu6e Fixing angles / Pie de empotramiento Montante da anegare / Angulos fixadores анкера		P 41A P 62B	0,37 0,65	0,37 0,65	1,14 1,27	135 295
Mát-châssis / Grundmasteinheit Basic mast unit / Tramo-chasis Elemento base / Tramo-chassis Мачта для крепления к шасси		S 41A V 60A	3,63 5,01	1,96 2,41	2,08 2,41	2965 4390
Haubans / Mastabstutzungen Struts / Tornapuntas Puntoni / Escoras Растяжка		S 41A V 60A	3,18 4,51	0,26 0,29	0,24 0,29	220 420
Sommier / Unterwagenhâlfte Half-bearer / Testero Testata / Estrutura base Траверса		S 41A V 60A	5,1 6,7	0,6 0,7	1,78 2,31	1145 1600

Mécanismes / Triebwerke / Mechanisms / Mecanismos / Meccanismi
 Mecanismos / Механизмы

400 V - 50 Hz 480 V - 60 Hz										ch - PS hp	kW		
	33 LVF 20 Optima	m/min	26	34	50	71	13	17	25	35,5	33	22	469 m
	t	4	3	2	1	8	6	4	2				
	50 LVF 20 Optima	m/min	44	58	82	118	22	29	41	59	50	37	697 m
	t	4	3	2	1	8	6	4	2				
	50 VVF 20		1 min 25 s							50	37		
	RVF 152 Optima+	tr/min U/min rpm	0 → 0,8							2 x 5,5	2 x 4		

IEC 60204-32	kVA
400 V (+10% -10%) 50 Hz 480 V (+6% -10%) 60 Hz	33 LVF : 76 → 63 kVA 50 LVF : 90 kVA

33 LVF 20 Optima

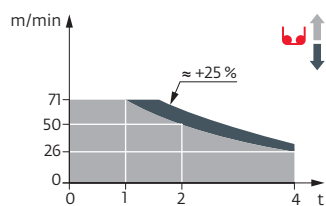

50 LVF 20 Optima

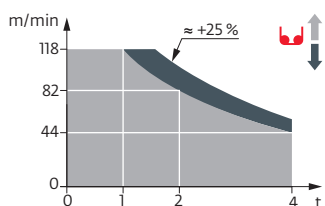

	FR	DE	EN	ES	IT	PT	RU
	Équipements standards	Standardausrüstungen	Standard equipment	Equipamiento de serie	Equipaggiamento standard	Equipamento de série	Стандартное оборудование
	Équipements optionnels	Sonderausrüstungen	Options	Equipamiento opcional	Equipaggiamento in opzione	Equipamento opcional	Дополнительное оборудование (опция)
	Réactions en service	Reaktionskräfte in Betrieb	Reactions in service	Reacciones en servicio	Reazioni in servizio	Reações em serviço	Реакция при работе
	Réactions hors service	Reaktionskräfte außer Betrieb	Reactions out of service	Reacciones fuera de servicio	Reazioni fuori servizio	Reações fora de serviço	Реакция в покое
	Poids à vide sans lest avec flèche et hauteur maximum	Gewicht ohne Last, ohne Ballast, mit Ausleger und max. Höhe	Weight without load, without ballast, with jib and max. height	Peso en vacío sin lastre, con flecha y altura máxima	Peso a vuoto, senza zavorra, con braccio e altezza massimi.	Peso em vazio sem lastro com lança e altura máxima.	Вес пустого, без балласта, со стрелой, максимальной высоты.
	Poids de flèche	Auslegergewicht	Jib weight	Peso de flecha	Peso del braccio	Peso da lança	Вес стрелы
	Poids total du lest	Ballast-Gesamtgewicht	Total ballast weight	Peso total del lastre	Peso totale della zavorra	Peso total do lastro	Общий вес балласта
	Courbes de charges sans plate-forme d'intervention	Lastkurven ohne Arbeitsbühne	Load curves without inspection platform	Curvas de cargas sin plataforma de servicio	Curve di carico senza piattaforma di intervento	Curvas de carga sem plataforma de intervenção	Кривые грузоподъемности без технической платформой
	Courbes de charges avec plate-forme d'intervention d'éduire 0,1 t	Lastkurven mit Arbeitsbühne 0,1 t abziehen	Load curves with inspection platform, deduct 0,1 t	Curvas de cargas con plataforma de servicio descontar 0,1 t	Curve di carico con piattaforma di intervento detrarre 0,1 t	Curvas de carga com plataforma de intervenção deduzir 0,1 ton	Кривые грузоподъемности с технической платформой - вычисть 0,1 т
	Axe articulation flèche	Auslegergelenk-achse	Jib articulation axis	Eje de articulación de la flecha	Perno di articolazione del braccio	Eixo de articulação da lança	Ось шарнира стрелы
	Position girouette	Windfreistellung	Weather vaning position	Posición veleta	Libera rotazione	Posição em cata-vento	Флюгер
	Camion 13,4 m	Lkw 13,4 m	Lorry 13,4 m	Camión 13,4 m	Camion 13,4 m	Camião 13,4 m	Ррузовой автомобиль 13,4 м
	Conteneur High Cube 40', et/ou Flat Rack 20'	Container High Cube 40', und/oder Flat Rack 20'	Container High Cube 40', and/or Flat Rack 20'	Contenedor High Cube 40', y/o Flat Rack 20'	Container High Cube 40', e/o Flat Rack 20'	Contentor High Cube 40', e/ou Flat Rack 20'	40-футовый контейнер повышенной вместимости High Cube, и/или 20-футовая открытая платформа Flat Rack
	Cadre d'ancrage serré	Fester Verankerungsrahmen	Tightened anchorage frame	Marco de anclaje de apriete	Quadro di ancoraggio stretto	Quadro de amarração apertado	Прикрепленная анкерная рама
	Cadre d'ancrage desserré	Looser Verankerungsrahmen	Loosened anchorage frame	Marco de anclaje de desapriete	Quadro di ancoraggio allentato	Quadro de amarração solto	Отсоединенная анкерная рама
	Levage	Heben	Hoisting	Elevación	Sollevamento	Elevação	Подъем
	Relevage	AL-Verstellen	Luffing	Izado	Brandeggio	Levantamento	Маховый подъем
	Orientation	Schwenken	Slewing	Orientación	Rotazione	Rotação	Поворот
	Translation	Kranfahren	Travelling	Traslación	Traslazione	Translação	Перемещение крана
	Puissance requise	Erforderliche Leistung	Required power	Potencia Necesaria	Potenza richiesta	Potência Necessária	Потребляемая мощность
	Fonction Power Control : vitesses treuils adaptées à la puissance disponible	Funktion Power Control: Geschwindigkeiten der Triebwerke werden an die verfügbare Leistung angepasst	Power Control Function: winch speeds adapted to the available power	Función Power Control: marchas de los cabrestantes adaptadas a la potencia disponible	Funzione Power Control: velocità degli argani adattate alla potenza disponibile	Função Power Control: velocidades de guincho adaptadas à potência disponível	Функция контроля мощности Power Control: регулировка скорости лебедок в зависимости от доступной мощности
	Nous consulter	Auf Anfrage	Consult us	Consultarnos	Consultateci	Consultar-nos	Проконсультируйтесь у нас
	Document commercial non contractuel. Pour toute information technique se référer à la notice correspondante.	Unverbindliches Vertriebsdokument. Für technische Informationen, siehe die entsprechenden Anweisungen.	This commercial document is not legally binding. For any technical information, please refer to the corresponding instructions.	Documento comercial no contractual. Para cualquier información técnica, ver la noticia correspondiente.	Documento commerciale non vincolante, per tutte le informazioni tecniche fare riferimento al catalogo istruzioni.	Documento comercial não contractual. Para qualquer informação técnica complementar consultar as respectivas instruções.	Этот коммерческий документ не является юридически обязательным. Для получения технической информации, см. соответствующие инструкции.

