

Liftcrane Boom Capacities With Luffing Jib Attached

MLC300 SERIES 1

Boom No. B10:500
Luffing Jib No. LJ10:501
135 200 kg VPC (Variable Position Counterweight)
360 Degree Rating

 **LIFTING CAPACITIES:** Lifting capacities for various boom lengths, luffing jib lengths, boom-to-luffing jib angles, and boom operating radii are for freely suspended loads and may be based on percent of static tipping or strength of structural components. Capacities must be reduced by applicable deducts.

Weight of all load blocks, hooks, weight ball, slings, hoist lines, etc., beneath boom point sheaves, is considered part of load. Weight of luffing jib and 5 000 kg suspended beneath luffing jib point sheaves have been included in capacity determination. Boom is not to be lowered beyond radii where combined weights are greater than rated capacity. Where no capacity is shown, operation is not intended or approved.

OPERATING CONDITIONS: Machine to operate on a firm, level, and uniformly supporting surface. Supporting surface and bearing turntable are to be level within a tolerance of 13 mm in 3 m. During operation, luffing jib must be maintained at proper boom-to-luffing jib angle shown in table. Refer to Luffing Jib Rigging **No. 81023383**, Wire Rope Specifications chart **No. 9813-A**, Counterweight Arrangements chart **No. 9345-A**, Luffing Jib Raising Procedure chart **No. 9380-AM**, and Wind Conditions chart **No. 9371-A**. Crane operator judgment must be used to allow for dynamic load effects of swinging, hoisting or lowering, travel, wind conditions, as well as adverse operating conditions and physical machine depreciation. Refer to the Operator Manual for operating guidelines.

MACHINE TRAVEL: Machine to travel on a firm, level, and uniformly supporting surface. Boom and luffing jib must be within angle range shown in capacity chart. Refer to Maximum Allowable Travel Specifications chart **No. 9372-A**.

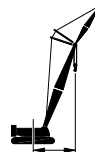

OPERATING RADIUS: Operating radius is horizontal distance from axis of rotation to center of vertical hoist line or load block.



BOOM ANGLE: Boom angle in degrees (°) is angle between horizontal and centerline of boom butt and inserts, and is an indication of operating radius. In all cases, operating radius shall govern capacity.









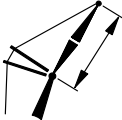
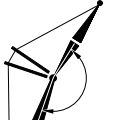

BOOM POINT ELEVATION: Boom point elevation is vertical distance from ground level to centerline of boom point shaft.

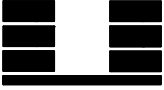
MACHINE EQUIPMENT: Machine equipped with 9 700 mm crawlers, 1 219 mm or 1 524 mm treads, 9 144 mm live mast, 24 part boom hoist reeving, boom support straps, 14 part luffing jib hoist reeving, luffing jib and backstay support straps, and 135 200 kg VPC.

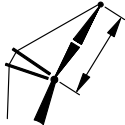
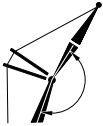
Consult chart **No. 9378-AM** for luffing jib capacities.

Luffing Jib Position During Operation	
	
Luffing Jib Length Meters	Boom-to-Luffing Jib Angle Degrees
24,0 - 30,0	140
36,0 - 48,0	155
54,0 - 96,0	169

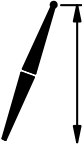
Explanation of Symbols

-  LJ10 Luffing Jib No. LJ10:501
+
B10 Boom No. B10:500
-  VPC (Variable Position Counterweight)
-  360°
360 Degree Rating
-  Luffing Jib Length
-  Boom-to-Luffing Jib Angle
-  Boom Length
-  Operating Radius
(see page 1)
-  Boom Angle
(see page 1)
-  Boom Point Elevation
(see page 1)
-  Lifting Capacities
(see page 1)

MLC300 S-1

ASME B30.5

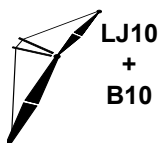

135 200 kg



30,0 m			
m	o	m	kg
5,5	84,5	31,9	266 700
6,0	83,5	31,9	266 700
6,5	82,5	31,8	266 700
7,0	81,6	31,7	266 200
7,5	80,6	31,6	259 400
8,0	79,6	31,5	241 500
9,0	77,6	31,2	197 000
10,0	75,7	31,0	162 900
11,0	73,7	30,7	135 900
12,0	71,6	30,3	115 700
13,0	69,6	29,9	100 400
14,0	67,5	29,5	86 800
15,0	65,4	29,0	76 000
16,0	63,2	28,5	67 100
17,0	61,0	27,9	59 200
18,0	58,8	27,3	52 600
19,0	56,5	26,6	46 900
20,0	54,1	25,8	41 700
21,0	51,6	25,0	37 300
22,0	49,0	24,1	33 300
24,0	43,6	22,1	26 400

36,0 m			
m	o	m	kg
5,8	84,9	37,9	265 300
6,0	84,6	37,9	264 300
6,5	83,8	37,8	261 700
7,0	83,0	37,8	259 300
7,5	82,2	37,7	253 600
8,0	81,4	37,6	240 700
9,0	79,7	37,4	199 400
10,0	78,1	37,2	164 400
11,0	76,5	36,9	137 300
12,0	74,8	36,6	117 000
13,0	73,1	36,3	101 500
14,0	71,5	36,0	87 900
15,0	69,7	35,6	77 100
16,0	68,0	35,2	68 100
17,0	66,3	34,7	60 100
18,0	64,5	34,2	53 500
19,0	62,7	33,7	47 700
20,0	60,9	33,1	42 500
21,0	59,0	32,5	38 000
22,0	57,1	31,8	34 000
24,0	53,1	30,3	27 100
26,0	48,9	28,6	21 400
28,0	44,4	26,6	16 800

42,0 m			
m	o	m	kg
6,4	84,8	43,9	240 100
6,5	84,7	43,9	239 700
7,0	84,0	43,8	237 400
7,5	83,3	43,8	235 200
8,0	82,6	43,7	231 600
9,0	81,2	43,5	200 700
10,0	79,8	43,3	165 500
11,0	78,4	43,1	138 200
12,0	77,0	42,9	117 800
13,0	75,6	42,6	102 300
14,0	74,2	42,3	88 600
15,0	72,8	42,0	77 700
16,0	71,3	41,6	68 700
17,0	69,9	41,2	60 700
18,0	68,4	40,8	54 000
19,0	66,9	40,4	48 200
20,0	65,4	39,9	43 000
21,0	63,9	39,4	38 500
22,0	62,3	38,9	34 500
24,0	59,1	37,7	27 500
26,0	55,8	36,3	21 800
28,0	52,4	34,8	17 100
30,0	48,8	33,1	13 000
32,0	45,0	31,1	9 500

MLC300 S-1

ASME B30.5

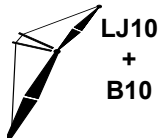

<p>48,0 m</p>			
<p>m</p>	<p>°</p>	<p>m</p>	<p>kg</p>
7,3	84,4	49,8	217 400
7,5	84,1	49,8	216 700
8,0	83,5	49,8	214 900
9,0	82,3	49,6	200 400
10,0	81,1	49,4	166 200
11,0	79,9	49,3	138 800
12,0	78,7	49,0	118 300
13,0	77,5	48,8	102 700
14,0	76,2	48,5	89 000
15,0	75,0	48,3	78 000
16,0	73,7	48,0	68 900
17,0	72,5	47,6	60 900
18,0	71,2	47,3	54 200
19,0	69,9	46,9	48 400
20,0	68,7	46,5	43 100
21,0	67,4	46,1	38 600
22,0	66,1	45,6	34 500
24,0	63,4	44,6	27 500
26,0	60,6	43,5	21 800
28,0	57,8	42,2	17 000
30,0	54,9	40,8	13 000
32,0	51,9	39,3	9 400
34,0	48,7	37,5	6 400
36,0	45,4	35,6	3 800
38,0	41,9	33,4	1 400

REFERENCE ONLY!

MLC300 S-1

ASME B30.5

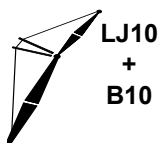

135 200 kg

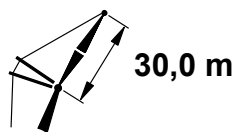

30,0 m			
m	o	m	kg
5,5	84,5	31,9	266 700
6,0	83,5	31,9	266 700
6,5	82,5	31,8	266 700
7,0	81,6	31,7	266 200
7,5	80,6	31,6	258 900
8,0	79,6	31,5	239 500
9,0	77,6	31,2	188 900
10,0	75,7	31,0	153 700
11,0	73,7	30,7	127 700
12,0	71,6	30,3	108 100
13,0	69,6	29,9	93 300
14,0	67,5	29,5	80 300
15,0	65,4	29,0	69 900
16,0	63,2	28,5	61 300
17,0	61,0	27,9	53 600
18,0	58,8	27,3	47 300
19,0	56,5	26,6	41 800
20,0	54,1	25,8	36 800
21,0	51,6	25,0	32 500
22,0	49,0	24,1	28 700
24,0	43,6	22,1	22 200

36,0 m			
m	o	m	kg
5,8	84,9	37,9	258 800
6,0	84,6	37,9	257 700
6,5	83,8	37,8	255 100
7,0	83,0	37,8	252 700
7,5	82,2	37,7	249 000
8,0	81,4	37,6	240 000
9,0	79,7	37,4	190 900
10,0	78,1	37,2	155 500
11,0	76,5	36,9	129 300
12,0	74,8	36,6	109 600
13,0	73,1	36,3	94 700
14,0	71,5	36,0	81 600
15,0	69,7	35,6	71 100
16,0	68,0	35,2	62 400
17,0	66,3	34,7	54 800
18,0	64,5	34,2	48 300
19,0	62,7	33,7	42 800
20,0	60,9	33,1	37 800
21,0	59,0	32,5	33 400
22,0	57,1	31,8	29 600
24,0	53,1	30,3	22 900
26,0	48,9	28,6	17 500
28,0	44,4	26,6	13 000

42,0 m			
m	o	m	kg
6,4	84,8	43,9	234 200
6,5	84,7	43,9	233 700
7,0	84,0	43,8	231 400
7,5	83,3	43,8	229 200
8,0	82,6	43,7	225 700
9,0	81,2	43,5	192 400
10,0	79,8	43,3	156 800
11,0	78,4	43,1	130 400
12,0	77,0	42,9	110 700
13,0	75,6	42,6	95 700
14,0	74,2	42,3	82 500
15,0	72,8	42,0	71 900
16,0	71,3	41,6	63 200
17,0	69,9	41,2	55 500
18,0	68,4	40,8	49 000
19,0	66,9	40,4	43 400
20,0	65,4	39,9	38 400
21,0	63,9	39,4	34 000
22,0	62,3	38,9	30 100
24,0	59,1	37,7	23 400
26,0	55,8	36,3	17 900
28,0	52,4	34,8	13 400
30,0	48,8	33,1	9 500
32,0	45,0	31,1	6 200

MLC300 S-1

ASME B30.5

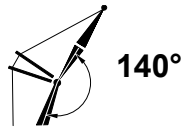
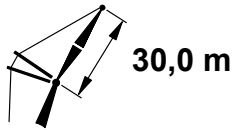
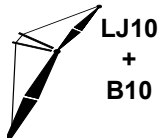

<p>48,0 m</p>			
<p>m</p>	<p>°</p>	<p>m</p>	<p>kg</p>
7,3	84,4	49,8	212 200
7,5	84,1	49,8	211 500
8,0	83,5	49,8	209 700
9,0	82,3	49,6	191 900
10,0	81,1	49,4	157 600
11,0	79,9	49,3	131 100
12,0	78,7	49,0	111 300
13,0	77,5	48,8	96 200
14,0	76,2	48,5	82 900
15,0	75,0	48,3	72 300
16,0	73,7	48,0	63 500
17,0	72,5	47,6	55 800
18,0	71,2	47,3	49 300
19,0	69,9	46,9	43 700
20,0	68,7	46,5	38 600
21,0	67,4	46,1	34 200
22,0	66,1	45,6	30 300
24,0	63,4	44,6	23 500
26,0	60,6	43,5	18 000
28,0	57,8	42,2	13 400
30,0	54,9	40,8	9 500
32,0	51,9	39,3	6 100
34,0	48,7	37,5	3 300

REFERENCE ONLY!

MLC300 S-1

ASME B30.5

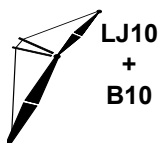

135 200 kg

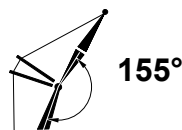
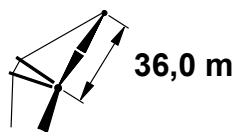

30,0 m

m	o	m	kg
5,5	84,5	31,9	266 700
6,0	83,5	31,9	266 700
6,5	82,5	31,8	266 700
7,0	81,6	31,7	266 200
7,5	80,6	31,6	259 400
8,0	79,6	31,5	241 100
9,0	77,6	31,2	191 200
10,0	75,7	31,0	155 000
11,0	73,7	30,7	128 200
12,0	71,6	30,3	108 100
13,0	69,6	29,9	92 800
14,0	67,5	29,5	79 400
15,0	65,4	29,0	68 700
16,0	63,2	28,5	59 800
17,0	61,0	27,9	51 900
18,0	58,8	27,3	45 400
19,0	56,5	26,6	39 700
20,0	54,1	25,8	34 500
21,0	51,6	25,0	30 100
22,0	49,0	24,1	26 200
24,0	43,6	22,1	19 400
26,0	37,4	19,5	13 800
28,0	30,2	16,3	9 200

36,0 m

m	o	m	kg
5,8	84,9	37,9	260 100
6,0	84,6	37,9	258 900
6,5	83,8	37,8	256 100
7,0	83,0	37,8	253 500
7,5	82,2	37,7	249 400
8,0	81,4	37,6	240 400
9,0	79,7	37,4	193 900
10,0	78,1	37,2	157 400
11,0	76,5	36,9	130 500
12,0	74,8	36,6	110 300
13,0	73,1	36,3	94 900
14,0	71,5	36,0	81 400
15,0	69,7	35,6	70 600
16,0	68,0	35,2	61 700
17,0	66,3	34,7	53 800
18,0	64,5	34,2	47 200
19,0	62,7	33,7	41 400
20,0	60,9	33,1	36 200
21,0	59,0	32,5	31 800
22,0	57,1	31,8	27 800
24,0	53,1	30,3	20 900
26,0	48,9	28,6	15 300
28,0	44,4	26,6	10 600
30,0	39,5	24,2	6 600
32,0	33,9	21,4	3 200

42,0 m

m	o	m	kg
6,4	84,8	43,9	235 100
6,5	84,7	43,9	234 600
7,0	84,0	43,8	232 200
7,5	83,3	43,8	229 800
8,0	82,6	43,7	226 600
9,0	81,2	43,5	195 800
10,0	79,8	43,3	159 200
11,0	78,4	43,1	132 100
12,0	77,0	42,9	111 800
13,0	75,6	42,6	96 300
14,0	74,2	42,3	82 700
15,0	72,8	42,0	71 900
16,0	71,3	41,6	62 900
17,0	69,9	41,2	55 000
18,0	68,4	40,8	48 300
19,0	66,9	40,4	42 600
20,0	65,4	39,9	37 300
21,0	63,9	39,4	32 900
22,0	62,3	38,9	28 800
24,0	59,1	37,7	21 900
26,0	55,8	36,3	16 200
28,0	52,4	34,8	11 600
30,0	48,8	33,1	7 500
32,0	45,0	31,1	4 100

MLC300 S-1

ASME B30.5

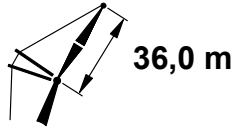
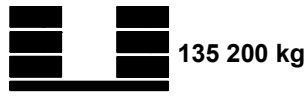
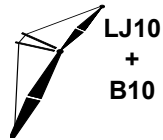

 m	 °	 m	 kg
7,3	84,4	49,8	212 700
7,5	84,1	49,8	211 900
8,0	83,5	49,8	210 000
9,0	82,3	49,6	194 700
10,0	81,1	49,4	160 400
11,0	79,9	49,3	133 100
12,0	78,7	49,0	112 700
13,0	77,5	48,8	97 200
14,0	76,2	48,5	83 600
15,0	75,0	48,3	72 600
16,0	73,7	48,0	63 600
17,0	72,5	47,6	55 600
18,0	71,2	47,3	48 900
19,0	69,9	46,9	43 100
20,0	68,7	46,5	37 900
21,0	67,4	46,1	33 400
22,0	66,1	45,6	29 400
24,0	63,4	44,6	22 400
26,0	60,6	43,5	16 700
28,0	57,8	42,2	12 000
30,0	54,9	40,8	7 900
32,0	51,9	39,3	4 400

REFERENCE ONLY!

MLC300 S-1

ASME B30.5

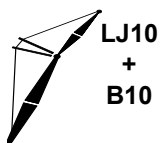

135 200 kg

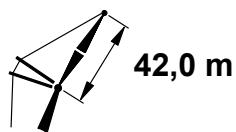

30,0 m

m	o	m	kg
5,5	84,5	31,9	266 700
6,0	83,5	31,9	266 000
6,5	82,5	31,8	263 500
7,0	81,6	31,7	261 000
7,5	80,6	31,6	252 500
8,0	79,6	31,5	232 400
9,0	77,6	31,2	181 800
10,0	75,7	31,0	146 500
11,0	73,7	30,7	120 400
12,0	71,6	30,3	100 900
13,0	69,6	29,9	86 100
14,0	67,5	29,5	73 000
15,0	65,4	29,0	62 500
16,0	63,2	28,5	53 900
17,0	61,0	27,9	46 300
18,0	58,8	27,3	39 900
19,0	56,5	26,6	34 400
20,0	54,1	25,8	29 400
21,0	51,6	25,0	25 100
22,0	49,0	24,1	21 300
24,0	43,6	22,1	14 700
26,0	37,4	19,5	9 300
28,0	30,2	16,3	5 000

36,0 m

m	o	m	kg
5,8	84,9	37,9	254 200
6,0	84,6	37,9	253 000
6,5	83,8	37,8	250 200
7,0	83,0	37,8	247 500
7,5	82,2	37,7	244 100
8,0	81,4	37,6	235 900
9,0	79,7	37,4	184 900
10,0	78,1	37,2	149 400
11,0	76,5	36,9	123 100
12,0	74,8	36,6	103 500
13,0	73,1	36,3	88 500
14,0	71,5	36,0	75 300
15,0	69,7	35,6	64 800
16,0	68,0	35,2	56 100
17,0	66,3	34,7	48 400
18,0	64,5	34,2	42 000
19,0	62,7	33,7	36 500
20,0	60,9	33,1	31 400
21,0	59,0	32,5	27 100
22,0	57,1	31,8	23 200
24,0	53,1	30,3	16 600
26,0	48,9	28,6	11 100
28,0	44,4	26,6	6 600
30,0	39,5	24,2	2 700

42,0 m

m	o	m	kg
6,4	84,8	43,9	229 800
6,5	84,7	43,9	229 300
7,0	84,0	43,8	226 900
7,5	83,3	43,8	224 500
8,0	82,6	43,7	220 800
9,0	81,2	43,5	187 100
10,0	79,8	43,3	151 400
11,0	78,4	43,1	125 000
12,0	77,0	42,9	105 200
13,0	75,6	42,6	90 200
14,0	74,2	42,3	77 000
15,0	72,8	42,0	66 400
16,0	71,3	41,6	57 600
17,0	69,9	41,2	49 900
18,0	68,4	40,8	43 400
19,0	66,9	40,4	37 800
20,0	65,4	39,9	32 700
21,0	63,9	39,4	28 400
22,0	62,3	38,9	24 500
24,0	59,1	37,7	17 800
26,0	55,8	36,3	12 200
28,0	52,4	34,8	7 700
30,0	48,8	33,1	3 800

MLC300 S-1

ASME B30.5

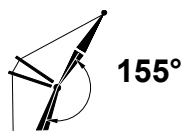
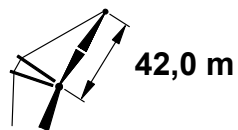
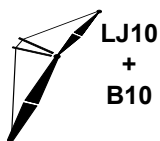

<p>48,0 m</p>			
<p>m</p>	<p>°</p>	<p>m</p>	<p>kg</p>
7,3	84,4	49,8	207 800
7,5	84,1	49,8	207 000
8,0	83,5	49,8	205 100
9,0	82,3	49,6	187 200
10,0	81,1	49,4	152 900
11,0	79,9	49,3	126 300
12,0	78,7	49,0	106 400
13,0	77,5	48,8	91 300
14,0	76,2	48,5	78 000
15,0	75,0	48,3	67 300
16,0	73,7	48,0	58 500
17,0	72,5	47,6	50 700
18,0	71,2	47,3	44 200
19,0	69,9	46,9	38 600
20,0	68,7	46,5	33 500
21,0	67,4	46,1	29 100
22,0	66,1	45,6	25 200
24,0	63,4	44,6	18 400
26,0	60,6	43,5	12 800
28,0	57,8	42,2	8 300
30,0	54,9	40,8	4 300
32,0	51,9	39,3	1 000

REFERENCE ONLY!

MLC300 S-1

ASME B30.5

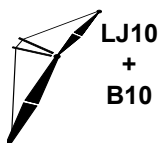

135 200 kg

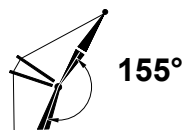
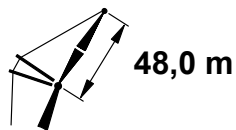

30,0 m

m	o	m	kg
5,5	84,5	31,9	262 000
6,0	83,5	31,9	259 000
6,5	82,5	31,8	256 200
7,0	81,6	31,7	253 600
7,5	80,6	31,6	243 600
8,0	79,6	31,5	220 200
9,0	77,6	31,2	171 100
10,0	75,7	31,0	137 000
11,0	73,7	30,7	111 700
12,0	71,6	30,3	92 800
13,0	69,6	29,9	78 400
14,0	67,5	29,5	65 800
15,0	65,4	29,0	55 600
16,0	63,2	28,5	47 300
17,0	61,0	27,9	39 900
18,0	58,8	27,3	33 800
19,0	56,5	26,6	28 500
20,0	54,1	25,8	23 600
21,0	51,6	25,0	19 500
22,0	49,0	24,1	15 800
24,0	43,6	22,1	9 500
26,0	37,4	19,5	4 400

36,0 m

m	o	m	kg
5,8	84,9	37,9	247 400
6,0	84,6	37,9	246 200
6,5	83,8	37,8	243 300
7,0	83,0	37,8	240 500
7,5	82,2	37,7	235 600
8,0	81,4	37,6	224 200
9,0	79,7	37,4	174 700
10,0	78,1	37,2	140 300
11,0	76,5	36,9	114 900
12,0	74,8	36,6	95 800
13,0	73,1	36,3	81 300
14,0	71,5	36,0	68 500
15,0	69,7	35,6	58 400
16,0	68,0	35,2	49 900
17,0	66,3	34,7	42 500
18,0	64,5	34,2	36 300
19,0	62,7	33,7	30 900
20,0	60,9	33,1	26 000
21,0	59,0	32,5	21 800
22,0	57,1	31,8	18 100
24,0	53,1	30,3	11 700
26,0	48,9	28,6	6 400

42,0 m

m	o	m	kg
6,4	84,8	43,9	223 500
6,5	84,7	43,9	223 000
7,0	84,0	43,8	220 500
7,5	83,3	43,8	218 100
8,0	82,6	43,7	213 900
9,0	81,2	43,5	177 300
10,0	79,8	43,3	142 700
11,0	78,4	43,1	117 100
12,0	77,0	42,9	97 900
13,0	75,6	42,6	83 300
14,0	74,2	42,3	70 500
15,0	72,8	42,0	60 200
16,0	71,3	41,6	51 700
17,0	69,9	41,2	44 200
18,0	68,4	40,8	38 000
19,0	66,9	40,4	32 500
20,0	65,4	39,9	27 600
21,0	63,9	39,4	23 400
22,0	62,3	38,9	19 600
24,0	59,1	37,7	13 100
26,0	55,8	36,3	7 800
28,0	52,4	34,8	3 400

MLC300 S-1

ASME B30.5

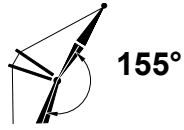
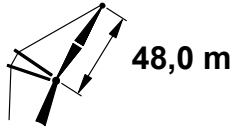
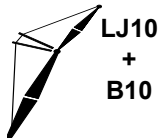

48,0 m			
m	°	m	kg
7,3	84,4	49,8	202 100
7,5	84,1	49,8	201 300
8,0	83,5	49,8	199 400
9,0	82,3	49,6	178 700
10,0	81,1	49,4	144 400
11,0	79,9	49,3	118 600
12,0	78,7	49,0	99 300
13,0	77,5	48,8	84 600
14,0	76,2	48,5	71 700
15,0	75,0	48,3	61 400
16,0	73,7	48,0	52 900
17,0	72,5	47,6	45 300
18,0	71,2	47,3	39 000
19,0	69,9	46,9	33 500
20,0	68,7	46,5	28 600
21,0	67,4	46,1	24 300
22,0	66,1	45,6	20 500
24,0	63,4	44,6	14 000
26,0	60,6	43,5	8 600
28,0	57,8	42,2	4 200

REFERENCE ONLY!

MLC300 S-1

ASME B30.5

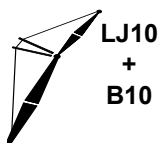

135 200 kg



360°

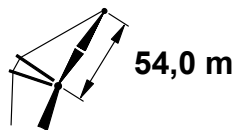

54,0 m

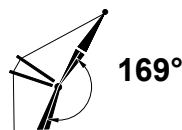

169°

30,0 m			
m	o	m	kg
5,5	84,5	31,9	266 700
6,0	83,5	31,9	266 700
6,5	82,5	31,8	264 500
7,0	81,6	31,7	261 500
7,5	80,6	31,6	254 300
8,0	79,6	31,5	237 400
9,0	77,6	31,2	184 100
10,0	75,7	31,0	147 100
11,0	73,7	30,7	119 600
12,0	71,6	30,3	99 000
13,0	69,6	29,9	83 400
14,0	67,5	29,5	69 600
15,0	65,4	29,0	58 600
16,0	63,2	28,5	49 500
17,0	61,0	27,9	41 400
18,0	58,8	27,3	34 700
19,0	56,5	26,6	28 800
20,0	54,1	25,8	23 500
21,0	51,6	25,0	19 000
22,0	49,0	24,1	14 900
24,0	43,6	22,1	7 800

36,0 m			
m	o	m	kg
5,8	84,9	37,9	256 200
6,0	84,6	37,9	254 800
6,5	83,8	37,8	251 600
7,0	83,0	37,8	248 500
7,5	82,2	37,7	245 500
8,0	81,4	37,6	239 100
9,0	79,7	37,4	188 700
10,0	78,1	37,2	151 400
11,0	76,5	36,9	123 700
12,0	74,8	36,6	103 000
13,0	73,1	36,3	87 300
14,0	71,5	36,0	73 400
15,0	69,7	35,6	62 300
16,0	68,0	35,2	53 200
17,0	66,3	34,7	45 000
18,0	64,5	34,2	38 300
19,0	62,7	33,7	32 400
20,0	60,9	33,1	27 000
21,0	59,0	32,5	22 400
22,0	57,1	31,8	18 300
24,0	53,1	30,3	11 300
26,0	48,9	28,6	5 400

42,0 m			
m	o	m	kg
6,4	84,8	43,9	231 000
6,5	84,7	43,9	230 400
7,0	84,0	43,8	227 700
7,5	83,3	43,8	225 000
8,0	82,6	43,7	221 800
9,0	81,2	43,5	191 900
10,0	79,8	43,3	154 400
11,0	78,4	43,1	126 600
12,0	77,0	42,9	105 800
13,0	75,6	42,6	90 000
14,0	74,2	42,3	76 000
15,0	72,8	42,0	64 900
16,0	71,3	41,6	55 700
17,0	69,9	41,2	47 500
18,0	68,4	40,8	40 700
19,0	66,9	40,4	34 800
20,0	65,4	39,9	29 400
21,0	63,9	39,4	24 800
22,0	62,3	38,9	20 700
24,0	59,1	37,7	13 500
26,0	55,8	36,3	7 700
28,0	52,4	34,8	2 800

MLC300 S-1

ASME B30.5

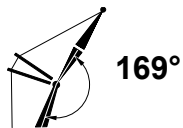
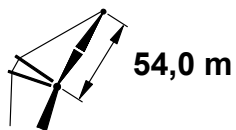
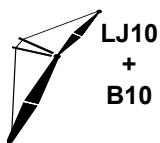

<p>48,0 m</p>			
<p>m</p>	<p>°</p>	<p>m</p>	<p>kg</p>
7,3	84,4	49,8	207 900
7,5	84,1	49,8	207 100
8,0	83,5	49,8	205 000
9,0	82,3	49,6	191 100
10,0	81,1	49,4	156 600
11,0	79,9	49,3	128 600
12,0	78,7	49,0	107 700
13,0	77,5	48,8	91 800
14,0	76,2	48,5	77 800
15,0	75,0	48,3	66 600
16,0	73,7	48,0	57 300
17,0	72,5	47,6	49 100
18,0	71,2	47,3	42 200
19,0	69,9	46,9	36 300
20,0	68,7	46,5	30 900
21,0	67,4	46,1	26 300
22,0	66,1	45,6	22 100
24,0	63,4	44,6	15 000
26,0	60,6	43,5	9 100
28,0	57,8	42,2	4 200

REFERENCE ONLY!

MLC300 S-1

ASME B30.5

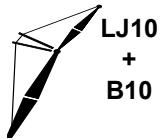

135 200 kg

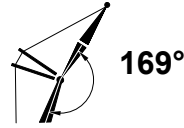

30,0 m			
m	o	m	kg
5,5	84,5	31,9	265 800
6,0	83,5	31,9	263 300
6,5	82,5	31,8	260 000
7,0	81,6	31,7	256 900
7,5	80,6	31,6	248 600
8,0	79,6	31,5	229 600
9,0	77,6	31,2	177 100
10,0	75,7	31,0	140 600
11,0	73,7	30,7	113 500
12,0	71,6	30,3	93 200
13,0	69,6	29,9	77 800
14,0	67,5	29,5	64 200
15,0	65,4	29,0	53 400
16,0	63,2	28,5	44 400
17,0	61,0	27,9	36 500
18,0	58,8	27,3	29 800
19,0	56,5	26,6	24 100
20,0	54,1	25,8	18 800
21,0	51,6	25,0	14 300
22,0	49,0	24,1	10 300
24,0	43,6	22,1	3 400

36,0 m			
m	o	m	kg
5,8	84,9	37,9	252 100
6,0	84,6	37,9	250 700
6,5	83,8	37,8	247 400
7,0	83,0	37,8	244 200
7,5	82,2	37,7	241 200
8,0	81,4	37,6	234 300
9,0	79,7	37,4	182 200
10,0	78,1	37,2	145 400
11,0	76,5	36,9	118 100
12,0	74,8	36,6	97 700
13,0	73,1	36,3	82 200
14,0	71,5	36,0	68 500
15,0	69,7	35,6	57 600
16,0	68,0	35,2	48 600
17,0	66,3	34,7	40 600
18,0	64,5	34,2	33 900
19,0	62,7	33,7	28 100
20,0	60,9	33,1	22 800
21,0	59,0	32,5	18 300
22,0	57,1	31,8	14 300
24,0	53,1	30,3	7 300

42,0 m			
m	o	m	kg
6,4	84,8	43,9	227 200
6,5	84,7	43,9	226 600
7,0	84,0	43,8	223 800
7,5	83,3	43,8	221 100
8,0	82,6	43,7	217 500
9,0	81,2	43,5	185 800
10,0	79,8	43,3	148 800
11,0	78,4	43,1	121 400
12,0	77,0	42,9	100 800
13,0	75,6	42,6	85 200
14,0	74,2	42,3	71 500
15,0	72,8	42,0	60 500
16,0	71,3	41,6	51 400
17,0	69,9	41,2	43 400
18,0	68,4	40,8	36 600
19,0	66,9	40,4	30 800
20,0	65,4	39,9	25 500
21,0	63,9	39,4	21 000
22,0	62,3	38,9	16 900
24,0	59,1	37,7	9 900

MLC300 S-1

ASME B30.5

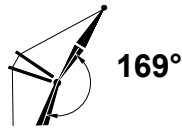
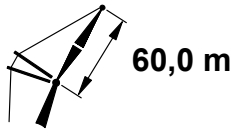
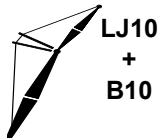

7,3	84,4	49,8	204 400
7,5	84,1	49,8	203 500
8,0	83,5	49,8	201 300
9,0	82,3	49,6	185 900
10,0	81,1	49,4	151 300
11,0	79,9	49,3	123 700
12,0	78,7	49,0	103 000
13,0	77,5	48,8	87 300
14,0	76,2	48,5	73 500
15,0	75,0	48,3	62 400
16,0	73,7	48,0	53 300
17,0	72,5	47,6	45 200
18,0	71,2	47,3	38 400
19,0	69,9	46,9	32 600
20,0	68,7	46,5	27 300
21,0	67,4	46,1	22 700
22,0	66,1	45,6	18 600
24,0	63,4	44,6	11 600
26,0	60,6	43,5	5 700

REFERENCE ONLY!

MLC300 S-1

ASME B30.5

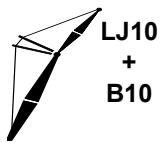

135 200 kg

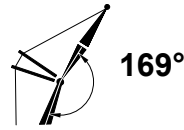

 30,0 m			
m	o	m	kg
5,5	84,5	31,9	261 600
6,0	83,5	31,9	258 000
6,5	82,5	31,8	254 600
7,0	81,6	31,7	251 300
7,5	80,6	31,6	241 800
8,0	79,6	31,5	220 600
9,0	77,6	31,2	168 900
10,0	75,7	31,0	133 000
11,0	73,7	30,7	106 400
12,0	71,6	30,3	86 400
13,0	69,6	29,9	71 300
14,0	67,5	29,5	57 900
15,0	65,4	29,0	47 200
16,0	63,2	28,5	38 400
17,0	61,0	27,9	30 600
18,0	58,8	27,3	24 100
19,0	56,5	26,6	18 400
20,0	54,1	25,8	13 300
21,0	51,6	25,0	8 900
22,0	49,0	24,1	4 900

 36,0 m			
m	o	m	kg
5,8	84,9	37,9	247 300
6,0	84,6	37,9	245 800
6,5	83,8	37,8	242 400
7,0	83,0	37,8	239 100
7,5	82,2	37,7	235 200
8,0	81,4	37,6	226 700
9,0	79,7	37,4	174 600
10,0	78,1	37,2	138 400
11,0	76,5	36,9	111 600
12,0	74,8	36,6	91 500
13,0	73,1	36,3	76 200
14,0	71,5	36,0	62 800
15,0	69,7	35,6	52 000
16,0	68,0	35,2	43 100
17,0	66,3	34,7	35 300
18,0	64,5	34,2	28 700
19,0	62,7	33,7	23 000
20,0	60,9	33,1	17 800
21,0	59,0	32,5	13 400
22,0	57,1	31,8	9 400
24,0	53,1	30,3	2 600

 42,0 m			
m	o	m	kg
6,4	84,8	43,9	222 500
6,5	84,7	43,9	221 900
7,0	84,0	43,8	219 100
7,5	83,3	43,8	216 300
8,0	82,6	43,7	212 200
9,0	81,2	43,5	178 700
10,0	79,8	43,3	142 300
11,0	78,4	43,1	115 300
12,0	77,0	42,9	95 100
13,0	75,6	42,6	79 700
14,0	74,2	42,3	66 200
15,0	72,8	42,0	55 300
16,0	71,3	41,6	46 400
17,0	69,9	41,2	38 500
18,0	68,4	40,8	31 800
19,0	66,9	40,4	26 100
20,0	65,4	39,9	20 900
21,0	63,9	39,4	16 400
22,0	62,3	38,9	12 400
24,0	59,1	37,7	5 500

MLC300 S-1

ASME B30.5

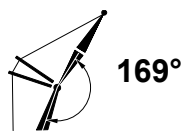
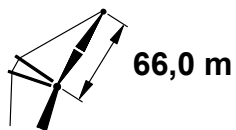
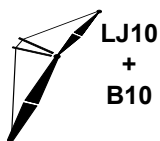

<p>48,0 m</p>			
<p>m</p>	<p>°</p>	<p>m</p>	<p>kg</p>
7,3	84,4	49,8	200 000
7,5	84,1	49,8	199 100
8,0	83,5	49,8	196 900
9,0	82,3	49,6	179 700
10,0	81,1	49,4	145 100
11,0	79,9	49,3	117 900
12,0	78,7	49,0	97 600
13,0	77,5	48,8	82 100
14,0	76,2	48,5	68 500
15,0	75,0	48,3	57 600
16,0	73,7	48,0	48 600
17,0	72,5	47,6	40 600
18,0	71,2	47,3	34 000
19,0	69,9	46,9	28 200
20,0	68,7	46,5	23 000
21,0	67,4	46,1	18 500
22,0	66,1	45,6	14 400
24,0	63,4	44,6	7 500

REFERENCE ONLY!

MLC300 S-1

ASME B30.5

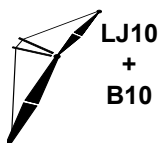

135 200 kg

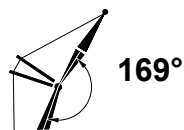
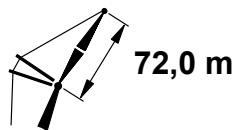

30,0 m			
m	o	m	kg
5,5	84,5	31,9	256 800
6,0	83,5	31,9	252 900
6,5	82,5	31,8	249 200
7,0	81,6	31,7	245 800
7,5	80,6	31,6	235 200
8,0	79,6	31,5	211 600
9,0	77,6	31,2	160 800
10,0	75,7	31,0	125 500
11,0	73,7	30,7	99 300
12,0	71,6	30,3	79 700
13,0	69,6	29,9	64 900
14,0	67,5	29,5	51 800
15,0	65,4	29,0	41 300
16,0	63,2	28,5	32 600
17,0	61,0	27,9	24 900
18,0	58,8	27,3	18 500
19,0	56,5	26,6	13 000
20,0	54,1	25,8	7 900
21,0	51,6	25,0	3 600

36,0 m			
m	o	m	kg
5,8	84,9	37,9	242 500
6,0	84,6	37,9	241 000
6,5	83,8	37,8	237 400
7,0	83,0	37,8	234 000
7,5	82,2	37,7	229 100
8,0	81,4	37,6	218 400
9,0	79,7	37,4	167 200
10,0	78,1	37,2	131 600
11,0	76,5	36,9	105 200
12,0	74,8	36,6	85 400
13,0	73,1	36,3	70 400
14,0	71,5	36,0	57 200
15,0	69,7	35,6	46 600
16,0	68,0	35,2	37 900
17,0	66,3	34,7	30 200
18,0	64,5	34,2	23 700
19,0	62,7	33,7	18 100
20,0	60,9	33,1	13 000
21,0	59,0	32,5	8 700
22,0	57,1	31,8	4 800

42,0 m			
m	o	m	kg
6,4	84,8	43,9	218 000
6,5	84,7	43,9	217 400
7,0	84,0	43,8	214 400
7,5	83,3	43,8	211 600
8,0	82,6	43,7	207 200
9,0	81,2	43,5	171 700
10,0	79,8	43,3	135 900
11,0	78,4	43,1	109 300
12,0	77,0	42,9	89 400
13,0	75,6	42,6	74 300
14,0	74,2	42,3	61 000
15,0	72,8	42,0	50 300
16,0	71,3	41,6	41 600
17,0	69,9	41,2	33 800
18,0	68,4	40,8	27 300
19,0	66,9	40,4	21 600
20,0	65,4	39,9	16 500
21,0	63,9	39,4	12 100
22,0	62,3	38,9	8 200

MLC300 S-1

ASME B30.5

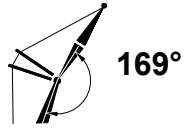
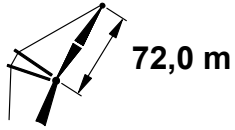
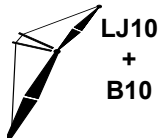

<p>48,0 m</p>			
<p>m</p>	<p>°</p>	<p>m</p>	<p>kg</p>
7,3	84,4	49,8	195 800
7,5	84,1	49,8	195 000
8,0	83,5	49,8	192 700
9,0	82,3	49,6	173 700
10,0	81,1	49,4	139 000
11,0	79,9	49,3	112 300
12,0	78,7	49,0	92 300
13,0	77,5	48,8	77 000
14,0	76,2	48,5	63 600
15,0	75,0	48,3	52 900
16,0	73,7	48,0	44 100
17,0	72,5	47,6	36 200
18,0	71,2	47,3	29 700
19,0	69,9	46,9	24 000
20,0	68,7	46,5	18 900
21,0	67,4	46,1	14 400
22,0	66,1	45,6	10 500
24,0	63,4	44,6	3 700

REFERENCE ONLY!

MLC300 S-1

ASME B30.5

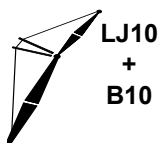

135 200 kg

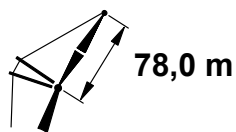

78,0 m

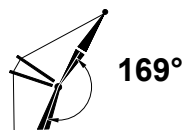

169°

<p>30,0 m</p>			
m	o	m	kg
5,5	84,5	31,9	251 100
6,0	83,5	31,9	247 000
6,5	82,5	31,8	243 200
7,0	81,6	31,7	239 600
7,5	80,6	31,6	227 700
8,0	79,6	31,5	201 600
9,0	77,6	31,2	151 800
10,0	75,7	31,0	117 100
11,0	73,7	30,7	91 500
12,0	71,6	30,3	72 300
13,0	69,6	29,9	57 700
14,0	67,5	29,5	44 800
15,0	65,4	29,0	34 500
16,0	63,2	28,5	26 100
17,0	61,0	27,9	18 500
18,0	58,8	27,3	12 300
19,0	56,5	26,6	6 800

<p>36,0 m</p>			
m	o	m	kg
5,8	84,9	37,9	237 000
6,0	84,6	37,9	235 400
6,5	83,8	37,8	231 700
7,0	83,0	37,8	228 200
7,5	82,2	37,7	222 200
8,0	81,4	37,6	209 100
9,0	79,7	37,4	158 900
10,0	78,1	37,2	123 900
11,0	76,5	36,9	98 000
12,0	74,8	36,6	78 600
13,0	73,1	36,3	63 900
14,0	71,5	36,0	50 900
15,0	69,7	35,6	40 500
16,0	68,0	35,2	32 000
17,0	66,3	34,7	24 400
18,0	64,5	34,2	18 000
19,0	62,7	33,7	12 600
20,0	60,9	33,1	7 600
21,0	59,0	32,5	3 300

<p>42,0 m</p>			
m	o	m	kg
6,4	84,8	43,9	212 900
6,5	84,7	43,9	212 300
7,0	84,0	43,8	209 300
7,5	83,3	43,8	206 300
8,0	82,6	43,7	201 500
9,0	81,2	43,5	163 900
10,0	79,8	43,3	128 700
11,0	78,4	43,1	102 600
12,0	77,0	42,9	83 100
13,0	75,6	42,6	68 200
14,0	74,2	42,3	55 200
15,0	72,8	42,0	44 700
16,0	71,3	41,6	36 100
17,0	69,9	41,2	28 400
18,0	68,4	40,8	22 000
19,0	66,9	40,4	16 500
20,0	65,4	39,9	11 500
21,0	63,9	39,4	7 200

REFERENCE

MLC300 S-1

ASME B30.5

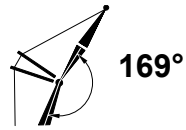
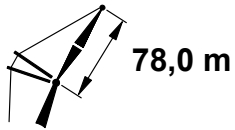
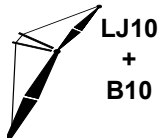

<p>48,0 m</p>			
<p>m</p>	<p>°</p>	<p>m</p>	<p>kg</p>
7,3	84,4	49,8	191 000
7,5	84,1	49,8	190 100
8,0	83,5	49,8	187 700
9,0	82,3	49,6	166 900
10,0	81,1	49,4	132 200
11,0	79,9	49,3	105 900
12,0	78,7	49,0	86 300
13,0	77,5	48,8	71 300
14,0	76,2	48,5	58 200
15,0	75,0	48,3	47 600
16,0	73,7	48,0	39 000
17,0	72,5	47,6	31 200
18,0	71,2	47,3	24 800
19,0	69,9	46,9	19 200
20,0	68,7	46,5	14 200
21,0	67,4	46,1	9 800
22,0	66,1	45,6	6 000

REFERENCE ONLY!

MLC300 S-1

ASME B30.5

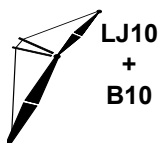

135 200 kg

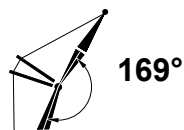
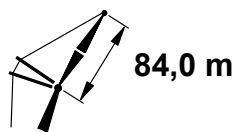

30,0 m

m	o	m	kg
5,5	84,5	31,9	245 900
6,0	83,5	31,9	241 700
6,5	82,5	31,8	237 700
7,0	81,6	31,7	233 900
7,5	80,6	31,6	220 700
8,0	79,6	31,5	191 900
9,0	77,6	31,2	143 100
10,0	75,7	31,0	109 100
11,0	73,7	30,7	84 000
12,0	71,6	30,3	65 100
13,0	69,6	29,9	50 800
14,0	67,5	29,5	38 200
15,0	65,4	29,0	28 200
16,0	63,2	28,5	19 900
17,0	61,0	27,9	12 500
18,0	58,8	27,3	6 400

36,0 m

m	o	m	kg
5,8	84,9	37,9	232 000
6,0	84,6	37,9	230 400
6,5	83,8	37,8	226 600
7,0	83,0	37,8	223 000
7,5	82,2	37,7	215 700
8,0	81,4	37,6	200 200
9,0	79,7	37,4	150 900
10,0	78,1	37,2	116 600
11,0	76,5	36,9	91 200
12,0	74,8	36,6	72 100
13,0	73,1	36,3	57 700
14,0	71,5	36,0	44 900
15,0	69,7	35,6	34 800
16,0	68,0	35,2	26 400
17,0	66,3	34,7	18 900
18,0	64,5	34,2	12 700
19,0	62,7	33,7	7 300

42,0 m





m	o	m	kg
6,4	84,8	43,9	208 100
6,5	84,7	43,9	207 500
7,0	84,0	43,8	204 400
7,5	83,3	43,8	201 300
8,0	82,6	43,7	196 100
9,0	81,2	43,5	156 400
10,0	79,8	43,3	121 800
11,0	78,4	43,1	96 200
12,0	77,0	42,9	77 000
13,0	75,6	42,6	62 500
14,0	74,2	42,3	49 700
15,0	72,8	42,0	39 400
16,0	71,3	41,6	30 900
17,0	69,9	41,2	23 400
18,0	68,4	40,8	17 200
19,0	66,9	40,4	11 700
20,0	65,4	39,9	6 800
21,0	63,9	39,4	2 600

REFERENCED

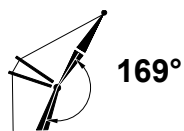
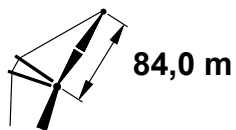
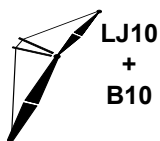
MLC300 S-1

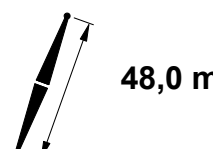
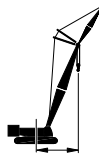
ASME B30.5

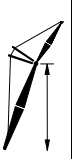

			
 m	 °	 m	 kg
7,3	84,4	49,8	186 400
7,5	84,1	49,8	185 500
8,0	83,5	49,8	183 100
9,0	82,3	49,6	160 500
10,0	81,1	49,4	125 700
11,0	79,9	49,3	99 900
12,0	78,7	49,0	80 600
13,0	77,5	48,8	65 900
14,0	76,2	48,5	53 000
15,0	75,0	48,3	42 700
16,0	73,7	48,0	34 100
17,0	72,5	47,6	26 600
18,0	71,2	47,3	20 300
19,0	69,9	46,9	14 800
20,0	68,7	46,5	9 800
21,0	67,4	46,1	5 600

REFERENCE ONLY!

MLC300 S-1

ASME B30.5

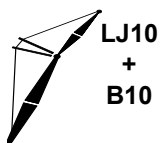

135 200 kg

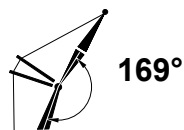
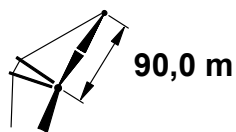

30,0 m

m	°	m	kg
5,5	84,5	31,9	239 600
6,0	83,5	31,9	235 200
6,5	82,5	31,8	231 000
7,0	81,6	31,7	227 000
7,5	80,6	31,6	212 500
8,0	79,6	31,5	181 000
9,0	77,6	31,2	133 300
10,0	75,7	31,0	100 000
11,0	73,7	30,7	75 400
12,0	71,6	30,3	57 000
13,0	69,6	29,9	43 000
14,0	67,5	29,5	30 700
15,0	65,4	29,0	20 900
16,0	63,2	28,5	12 800

36,0 m

m	°	m	kg
5,8	84,9	37,9	225 900
6,0	84,6	37,9	224 200
6,5	83,8	37,8	220 300
7,0	83,0	37,8	216 600
7,5	82,2	37,7	208 100
8,0	81,4	37,6	190 100
9,0	79,7	37,4	141 800
10,0	78,1	37,2	108 200
11,0	76,5	36,9	83 400
12,0	74,8	36,6	64 700
13,0	73,1	36,3	50 600
14,0	71,5	36,0	38 100
15,0	69,7	35,6	28 200
16,0	68,0	35,2	20 000
17,0	66,3	34,7	12 700
18,0	64,5	34,2	6 600

42,0 m

m	°	m	kg
6,4	84,8	43,9	202 400
6,5	84,7	43,9	201 700
7,0	84,0	43,8	198 500
7,5	83,3	43,8	195 400
8,0	82,6	43,7	189 700
9,0	81,2	43,5	147 900
10,0	79,8	43,3	114 000
11,0	78,4	43,1	89 000
12,0	77,0	42,9	70 200
13,0	75,6	42,6	55 900
14,0	74,2	42,3	43 300
15,0	72,8	42,0	33 300
16,0	71,3	41,6	25 000
17,0	69,9	41,2	17 700
18,0	68,4	40,8	11 500
19,0	66,9	40,4	6 200

REFERENCE

MLC300 S-1

ASME B30.5

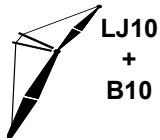

135 200 kg

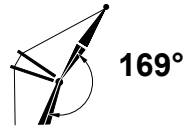
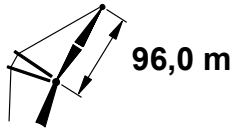

30,0 m

m	o	m	kg
5,5	84,5	31,9	233 500
6,0	83,5	31,9	228 800
6,5	82,5	31,8	224 500
7,0	81,6	31,7	219 400
7,5	80,6	31,6	203 200
8,0	79,6	31,5	170 200
9,0	77,6	31,2	123 500
10,0	75,7	31,0	91 000
11,0	73,7	30,7	67 000
12,0	71,6	30,3	49 000
13,0	69,6	29,9	35 400
14,0	67,5	29,5	23 300
15,0	65,4	29,0	13 700

36,0 m

m	o	m	kg
5,8	84,9	37,9	219 900
6,0	84,6	37,9	218 200
6,5	83,8	37,8	214 200
7,0	83,0	37,8	210 300
7,5	82,2	37,7	200 600
8,0	81,4	37,6	180 000
9,0	79,7	37,4	132 800
10,0	78,1	37,2	100 000
11,0	76,5	36,9	75 700
12,0	74,8	36,6	57 500
13,0	73,1	36,3	43 700
14,0	71,5	36,0	31 500
15,0	69,7	35,6	21 800
16,0	68,0	35,2	13 700

42,0 m

m	o	m	kg
6,4	84,8	43,9	196 800
6,5	84,7	43,9	196 100
7,0	84,0	43,8	192 900
7,5	83,3	43,8	189 700
8,0	82,6	43,7	183 600
9,0	81,2	43,5	139 500
10,0	79,8	43,3	106 300
11,0	78,4	43,1	81 800
12,0	77,0	42,9	63 400
13,0	75,6	42,6	49 500
14,0	74,2	42,3	37 200
15,0	72,8	42,0	27 400
16,0	71,3	41,6	19 300
17,0	69,9	41,2	12 100
18,0	68,4	40,8	6 100

REFERENCE