

MR 295 H20

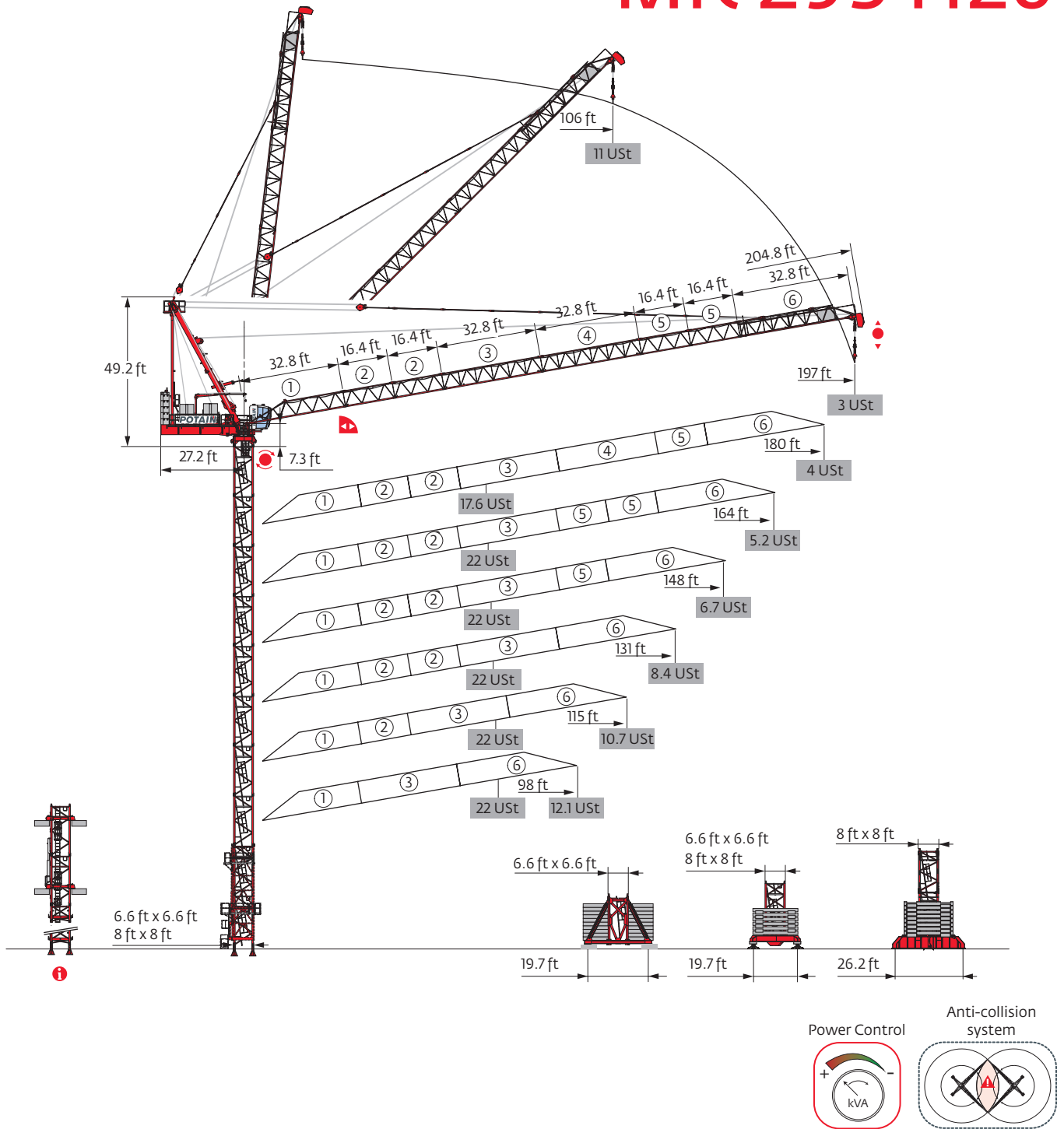

Mast - Reactions

6.6 ft - P 602B

Height (ft)	98	115	131	148	164	180	197
Height (ft)	183.4	177.8	172.2	161.4	150.6	145	139.4
10.9 ft	1	2	0	2	1	2	0
16.4 ft	10	9	10	8	8	7	8
F2 (Ust)	● 261	256	251	249	247	242	235
	■ 326	346	360	357	355	367	362
F3 (Ust)	● 206	201	197	184	183	181	176
	■ 271	291	306	304	302	315	311

6.6 ft - V 60A

Height (ft)	98	115	131	148	164	180	197
Height (ft)	164.7	148.3	137.1	126.3	115.5	104.3	93.5
10.9 ft	1	1	0	2	1	0	2
16.4 ft	8	7	7	5	5	5	3
F1 (Ust)	● 128	127	127	127	126	123	117
	■ 141	135	133	132	129	127	125

6.6 ft - ZX 6830

Height (ft)	98	115	131	148	164	180	197
Height (ft)	186.4	175.5	164.4	153.5	142.7	131.6	120.7
10.9 ft	1	0	2	1	0	2	1
16.4 ft	10	10	8	8	8	6	6
F1 (Ust)	● 144	147	150	150	146	146	137
	■ 173	175	175	173	169	168	165

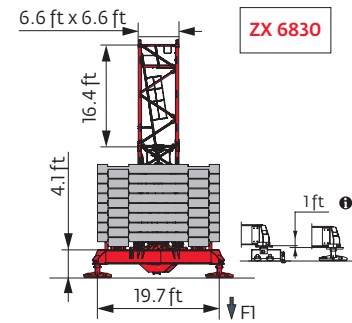
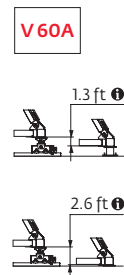
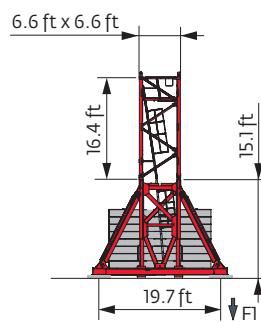
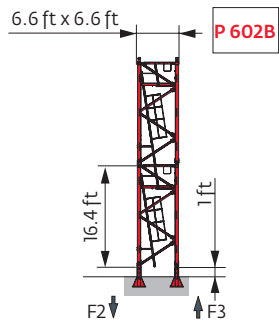

8 ft - P 802B

Wind Speed (ft)	98	115	131	148	164	180	197
Height (ft)	217.2	206.4	195.2	190	178.8	173.6	168
Accessories	6.6 ft	1	1	1	1	1	1
	10.9 ft	2	1	0	1	0	1
	16.4 ft	11	11	11	10	10	9
F2 (Ust)	● 262	251	239	235	232	228	222
	■ 400	395	388	399	392	402	399
F3 (Ust)	● 195	186	176	160	158	156	152
	■ 333	331	324	336	329	339	336

8 ft - ZX 6830

Wind Speed (ft)	98	115	131	148	164	180	197
Height (ft)	176.5	165.7	154.5	143.7	138.1	127.3	116.5
Accessories	6.6 ft	1	1	1	1	1	1
	10.9 ft	1	0	2	1	2	0
	16.4 ft	9	9	7	7	6	6
F1 (Ust)	● 146	148	149	145	149	145	139
	■ 178	176	176	170	176	172	166

8 ft - ZY 800

Wind Speed (ft)	98	115	131	148	164	180	197
Height (ft)	210.6	199.8	194.2	183.4	177.8	167	161.4
Accessories	6.6 ft	1	1	1	1	1	1
	10.9 ft	1	0	1	0	1	0
	16.4 ft	11	11	10	10	9	9
F1 (Ust)	● 145	147	151	146	150	146	141
	■ 194	191	198	191	196	190	195

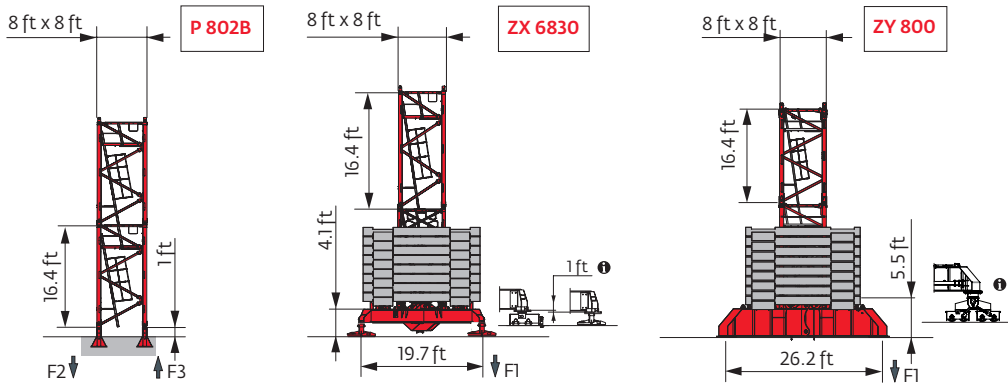

Note: When "ASCE" is noted in this data sheet it is referring to 115 mph Wind Zone, Exposure B, Design Wind Speed = 98 mph. See back cover for design wind speed calculations.

i Motorized accesses: adapted mast compositions, base ballast and reactions.

Anchorage

i

Base ballast

USt) / 6.6 ft - V60A -

AVAIL (ft)	98	115	131	148	164	180	197
164.7	145.5						
148.3	119.1	145.5					
137.1	119.1	119.1	145.5				
126.3	105.8	105.8	119.1	145.5			
115.5	105.8	105.8	105.8	119.1	145.5		
104.3	105.8	105.8	105.8	105.8	119.1	145.5	
93.5	105.8	105.8	105.8	105.8	105.8	119.1	145.5
77.1	105.8	105.8	105.8	92.6	92.6	105.8	105.8

USt) / 6.6 ft - ZX 6830 -

AVAIL (ft)	98	115	131	148	164	180	197
186.4	177.5						
175.5	155.4	188.5					
164.4	133.4	166.5	199.5				
153.5	111.3	144.4	166.5	199.5			
142.7	100.3	111.3	144.4	166.5	188.5		
131.6	100.3	100.3	122.4	144.4	166.5	199.5	
120.7	100.3	100.3	100.3	122.4	144.4	166.5	188.5
104.3	100.3	100.3	89.3	100.3	100.3	133.4	155.4
87.9	100.3	100.3	89.3	89.3	89.3	100.3	111.3

USt) / 8 ft - ZX 6830 -

AVAIL (ft)	98	115	131	148	164	180	197
176.5	188.5						
165.7	166.5	199.5					
154.5	133.4	166.5	199.5				
143.7	111.3	144.4	166.5	188.5			
138.1	100.3	122.4	155.4	177.5	199.5		
127.3	100.3	100.3	122.4	155.4	177.5	199.5	
116.5	100.3	100.3	100.3	122.4	144.4	166.5	199.5
100.1	100.3	100.3	100.3	100.3	111.3	133.4	155.4
83.7	100.3	100.3	100.3	100.3	100.3	100.3	111.3

USt) / 8 ft - ZY 800 -

AVAIL (ft)	98	115	131	148	164	180	197
210.6	172						
199.8	158.7	185.2					
194.2	145.5	172	198.4				
183.4	119.1	145.5	172	185.2			
177.8	105.8	132.3	158.7	172	198.4		
167	92.6	119.1	132.3	158.7	172	198.4	
161.4	79.4	105.8	119.1	145.5	158.7	185.2	198.4
145	52.9	79.4	92.6	105.8	132.3	145.5	172
128.6	39.7	39.7	66.1	79.4	92.6	119.1	132.3
112.2	39.7	39.7	39.7	52.9	66.1	92.6	105.8
95.8	39.7	39.7	39.7	39.7	39.7	52.9	79.4

Load curves

AVAIL (ft)	72	82	89	98	102	105	115	118	121	131	134	138	148	149	154	164	165	171	180	181	187	197	ft
197	16 → 106						9.6	-	8.7	7.5	-	6.8	6	-	5.4	4.6	-	4.2	4	-	3.5	3	USt
180	15 → 106						9.7	-	8.8	7.6	-	6.9	6.1	-	5.5	5	-	4.6	4	4			USt
164	14 → 107						9.8	-	8.9	7.8	-	7.1	6.2	-	6	5.2	5.1						USt
148	13 → 109						10.1	-	9.1	8		7.3	6.7	6.5									USt
131	12 → 110						10.3	-	9.4	8.4	8												USt
115	11 → 113						10.7	10.2															USt
98	10 → 102																						USt

AVAIL (ft)	56	66	72	82	89	98	102	105	115	118	121	131	134	138	148	149	154	164	165	171	180	181	ft
180	15 → 90	13.2	13.2	13.2	13.2	11.4	-	10.1	8.7	-	7.8	6.7	-	6.1	5.3	-	5	4.2	-	3.7	3.1	3.1	USt
164	14 → 77	16.5	16.5	16.5	15.1	13.4	-	10.1	8.7	-	7.8	7.1	-	6.4	5.5	-	5	4.2	4.1				USt
148	13 → 77	16.5	16.5	16.5	15.2	13.6	-	10.9	10.4	9.3	-	8.4	7.2	-	6.5	5.5	5.4						USt
131	12 → 78	16.5	16.5	16.5	15.4	13.8	11.7	-	9.4	-	8.5	7.3	7										USt
115	11 → 79	16.5	16.5	16.5	15.8	14.1	12.2	-	9.5	9.1													USt
98	10 → 79	16.5	16.5	16.5	15.7	14.2	12.1	11.4															USt

AVAIL (ft)	56	66	72	82	89	98	102	105	115	118	121	131	134	138	148	149	154	164	165	171	180	181	ft	
180	15 → 73	17.6	17.6	17.6	14.7	13	10.9	-	9.7	8.8	-	7.9	6.8	-	6.2	5.5	-	5.3	4.5	-	4	3.3	3.3	USt
164	14 → 62	22	20.3	17.7	14.7	13	-	-	10.3	8.8	-	8.2	7.4	-	6.7	5.7	-	5.2	4.4	4.3				USt
148	13 → 62	22	20.5	17.9	14.8	13.1	-	11	10.5	9.6	-	8.7	7.5	-	6.7	5.7	5.6							USt
131	12 → 63	22	20.7	18.1	15	13.3	11.2	-	9.7	-	8.8	7.5	7.3											USt
115	11 → 63	22	20.9	18.3	15.3	13.6	12	-	9.8	9.4														USt
98	10 → 64	22	21.2	18.5	15.5	14.3	12.1	11.4																USt

USt) = USt) - 0.6 USt

Jib weight & counter-jib ballast

	▲▲▲▲ (lb) (+/- 5%)			100 LVF			180 HPL™ GH		
	▲▲▲▲	▲▲	▲	8,708 lb	2,205 lb	▲ (lb)	8,708 lb	2,205 lb	▲ (lb)
197 ft	-	-	20,988	5	1	45,746	5	0	43,541
180 ft	20,745	20,216	19,709	5	1	45,746	5	0	43,541
164 ft	19,544	19,015	18,508	5	1	45,746	5	0	43,541
148 ft	18,232	17,703	17,196	5	0	43,541	4	3	41,447
131 ft	16,843	16,314	15,807	5	0	43,541	4	3	41,447
115 ft	15,102	14,573	14,065	5	0	43,541	4	3	41,447
98 ft	13,228	12,699	12,192	5	0	43,541	4	3	41,447

CBJ - 8,708 lb

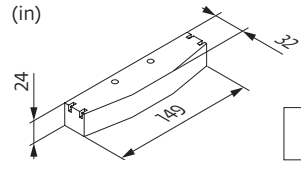

CBK - 2,205 lb

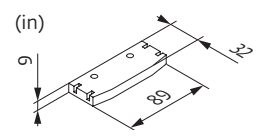



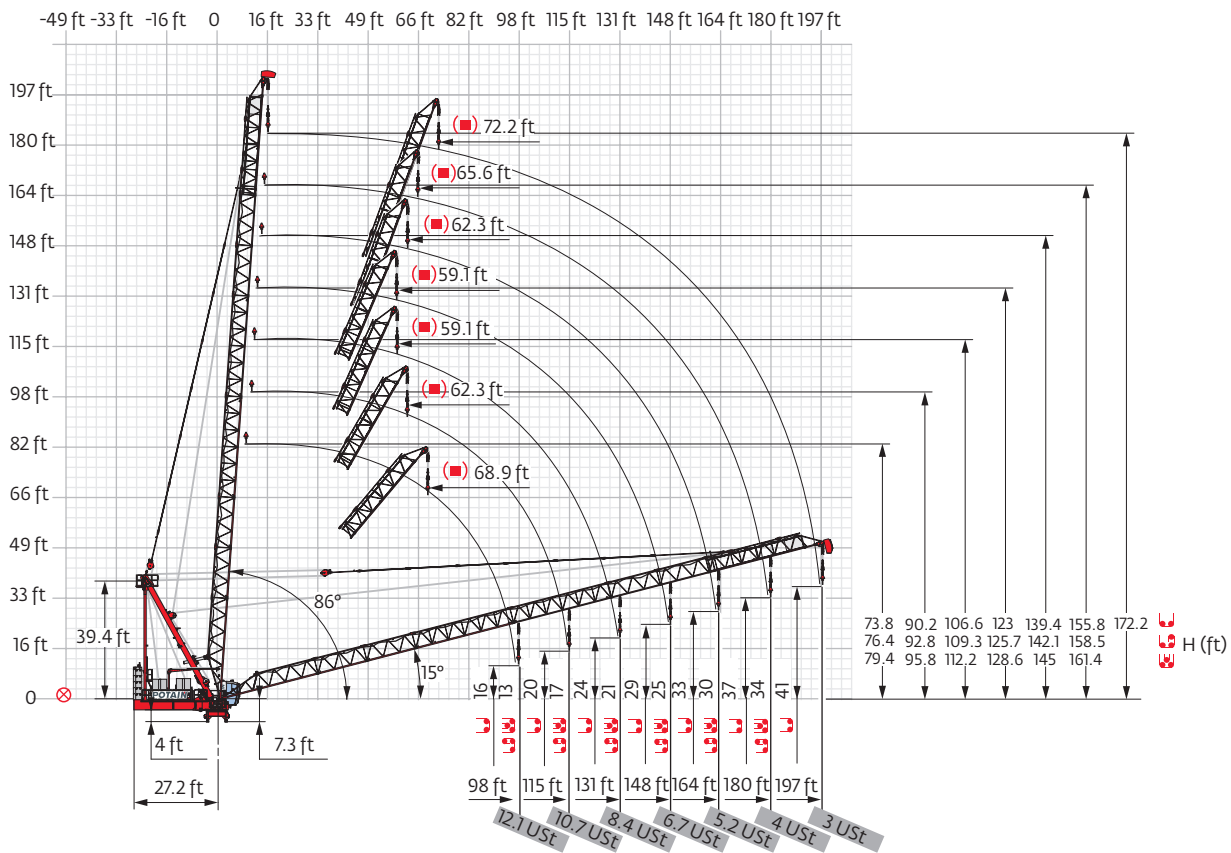



Luffing jib



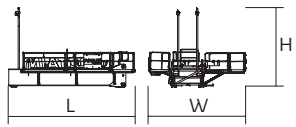
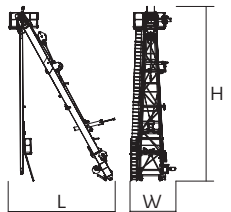
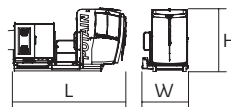
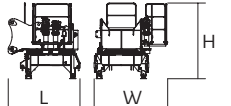



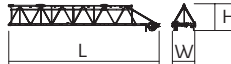
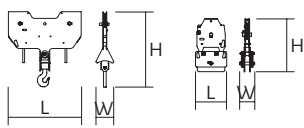
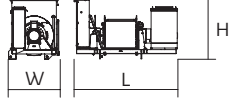

Dimensions and weight

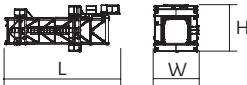
Slewing crane part:  197 ft -  100 LVF

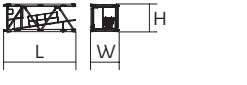
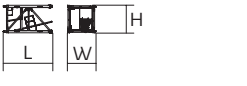
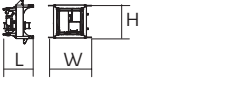
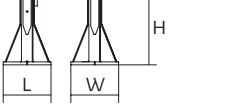

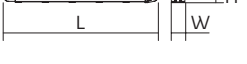
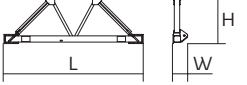
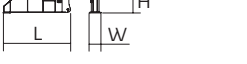
Slewing crane part			L (ft)	W (ft)	H (ft)	lb (+/- 5%)
Counter-jib		100 LVF 180 HPL™ GH	23.9 23.9	17.6 18.4	15.6 15.6	16,479 16,722
Strut			24.9	10.8	42.7	15,465
Cab		Ultra View	15.6	6.1	8.3	4,057
Towerhead		□ 6.6 ft	9.8	7.5	10.3	20,172
Jib section		①	33.7	6.2	6.5	3,241
Jib section		② ⑤	17 17	5.9 5.9	5.5 5.4	1,433 1,168
Jib section		③ ④	33.4 33.4	5.9 5.9	5.5 5.4	2,712 2,338
Jib section		⑥	38.7	6	6.5	2,998
Pulley block			5.9 2	1.4 0.6	8.8 3.8	1,087 897
Hoisting winch (+ rope)		100 LVF 180 HPL™ GH	10.4 15.8	5.2 6.1	6.2 6.2	9,822 30,216
Luffing winch (+ rope)		100 VVF	10.4	5.8	6.2	6,614

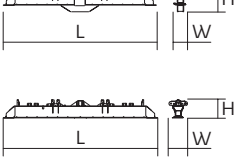
Crane tower			L (ft)	W (ft)	H (ft)	lb (+/- 5%)
T 61 T 851		□ 6.6 ft □ 8 ft	35.5 36.7	13.6 15.9	14.7 19	21,385 34,723
K 649B KM 649E		□ 6.6 ft □ 6.6 ft	33.6 33.8	6.8 6.7	6.7 6.7	11,663 10,692
K 649A KMT 649A KR 649A KRMT 649A K 849A KR 849A KMT 849A KRMT 849A		□ 6.6 ft □ 6.6 ft □ 6.6 ft □ 6.6 ft □ 8 ft □ 8 ft □ 8 ft □ 8 ft	17.2 17.2 17.2 17.2 17.2 17.2 17.2 17.2	6.8 6.8 6.9 6.8 8.3 8.3 8.4 8.3	6.7 6.7 6.8 6.8 8.2 8.2 8.3 8.3	6,184 5,666 7,165 6,724 7,496 9,458 6,945 9,017
K 649C KMT 649C KRMT 649C KRMT 849C		□ 6.6 ft □ 6.6 ft □ 6.6 ft □ 8 ft	11.7 11.7 11.7 11.7	6.8 6.8 6.9 8.4	6.7 6.7 6.8 8.3	4,376 4,542 5,401 7,066
K80/KR60-2 Connecting mast		□ 8/6.6 ft	7.3	10.7	8.1	8,852
Fixing angles		P 602B P 802B	2.1 2.5	2.1 2.5	4.2 4.2	650 1,025
Basic mast unit		V 60A	16.4	7.9	7.9	9,674
Struts		V 60A	14.8	1	1	919
Half-bearer		V 60A	22	2.3	7.6	3,519
1/2 Cross girder		ZY 800	18.6	3.2	6.3	10,406
Cross girder		ZY 800	39.2	4.6	6.3	22,212
Cross girder		ZX 6830	29.9 29.9	2.5 3.7	4.9 3.6	12,004 11,607

Mechanisms

480 V - 60 Hz													hp	kW	
	100 LVF 50 Optima	fpm	120	153	202	258	308	61	79	105	146	154	100	75	3,340 ft
		USt	11	8.3	5.5	2.8	1.4	22	16.5	11	5.5	4.3			
	180 HPL™ 50 GH	fpm	210	256	333	494	640	107	131	174	271	320	180	132	3,937 ft
		USt	11	8.3	5.5	2.8	0.9	22	16.5	11	5.5	3.3			
	100 VVF 40		1 min 40 s									100	75		
	RVF 172 Optima+	rpm	0 → 0.8									2 x 10	2 x 7.5		

IEC 60204-32	kVA
480 V (+6% -10%) 60 Hz	100 LVF : 179 kVA 180 HPL™ GH : 243 → 171 kVA

100 LVF 50 Optima

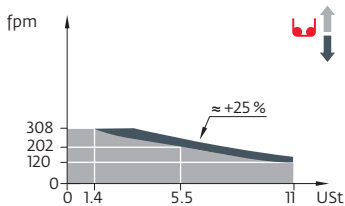

These mast combinations meet the EN 14439 and ASME B30.3-2016 specifications for “out of service” wind conditions, provided the illustrated wind speed matches required design wind speed for the location of the tower crane. The “out of service” design wind speed was determined in accordance with ASCE 7-10, Figure 26.5-1A. The wind velocity, used for this configuration was 98 mph (158 kph), which represents a nominal design 3-second wind gust at 33 ft (10 m) above ground for Exposure B category. A factor of 0.85 was applied to the 700-year ultimate design wind speed of 115 mph (185 kph), per ASCE 37-02, with the assumption that this crane is considered a temporary structure used during a construction period of 2 years or less.

- Standard equipment
- Options
- Reactions in service
- Reactions out of service
- Jib weight
- Jib articulation axis
- Weather vaning position
- Lorry 44 ft
- Container High Cube 40 ft, and/or Flat Rack 20 ft
- Hoisting
- Luffing
- Slewing
- Travelling
- Required power
- Power Control Function: winch speeds adapted to the available power
- Consult us

This commercial document is not legally binding. For any technical information, please refer to the corresponding instructions.

