

MR 298

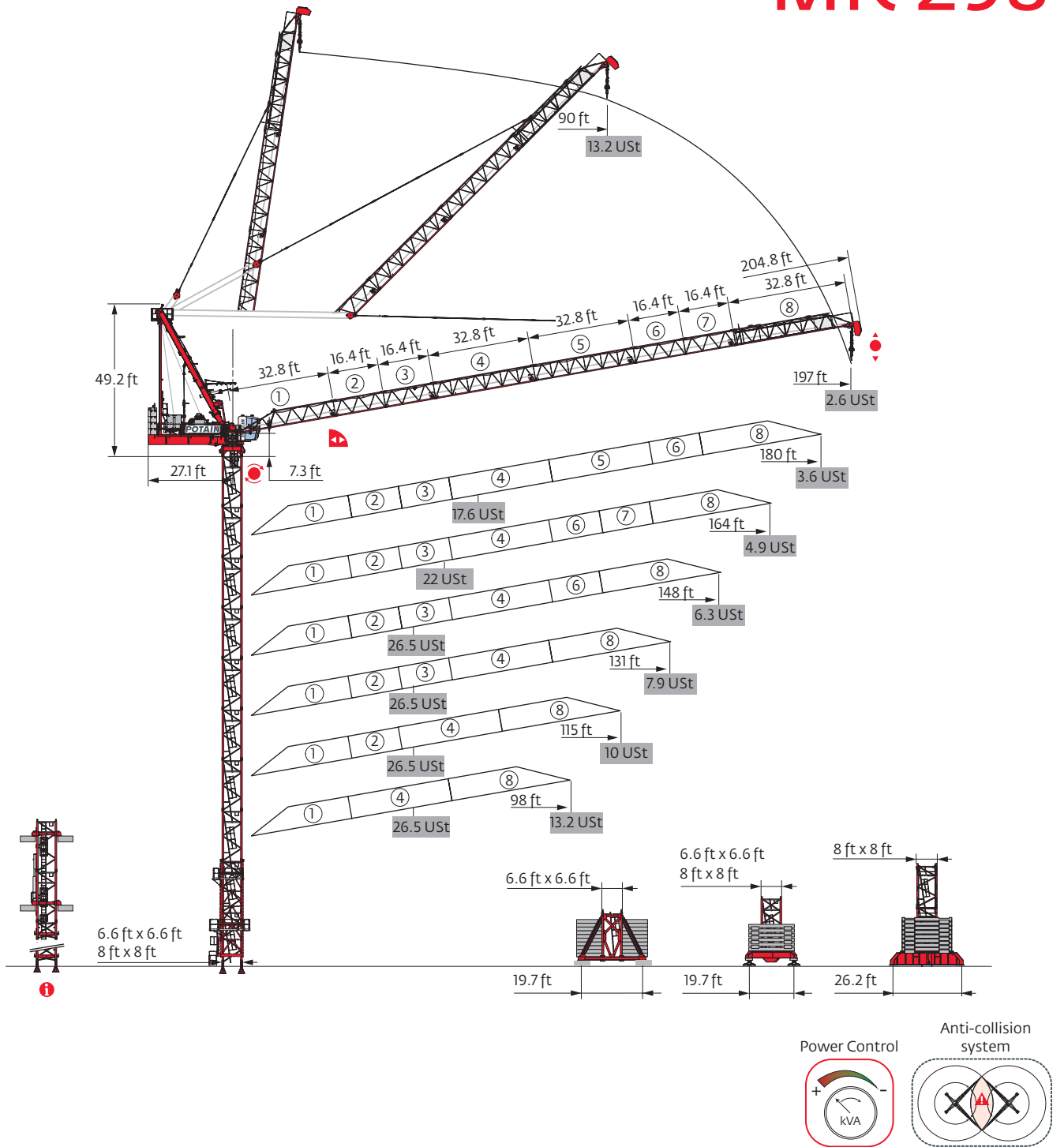

Mast - Reactions

6.6 ft - P 602B							
Span (ft)	98	115	131	148	164	180	197
Height (ft)	183.4	177.8	172.2	161.4	150.6	139.4	139.4
Lift-off	10.9 ft	1	2	0	2	1	0
	16.4 ft	10	9	10	8	8	8
F2 (Ust)	●	249	244	248	249	247	238
	■	326	346	360	357	355	349
F3 (Ust)	●	179	177	183	184	183	178
	■	271	291	306	304	298	311

6.6 ft - V60A							
Span (ft)	98	115	131	148	164	180	197
Height (ft)	164.7	148.3	137.1	126.3	115.5	104.3	99.1
Lift-off	10.9 ft	1	1	0	2	1	0
	16.4 ft	8	7	7	5	5	4
F1 (Ust)	●	132	126	126	126	125	119
	■	138	132	132	131	130	127

6.6 ft - ZX 6830							
Span (ft)	98	115	131	148	164	180	197
Height (ft)	180.8	175.5	159.1	148	137.1	126.3	120.7
Lift-off	10.9 ft	2	0	0	2	1	0
	16.4 ft	9	10	9	7	7	6
F1 (Ust)	●	146	148	144	146	146	142
	■	165	176	166	166	165	162

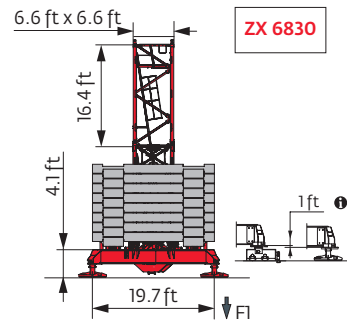
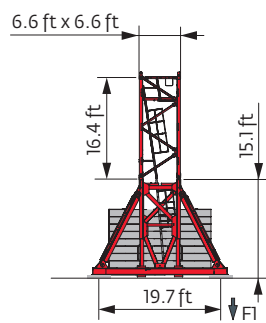
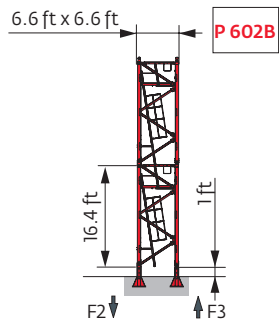

8 ft - P 802B

Span (ft)	98	115	131	148	164	180	197
Height (ft)	217.2	206.4	195.2	190	178.8	173.6	168
Accessories	6.6 ft	1	1	1	1	1	1
	10.9 ft	2	1	0	1	0	1
	16.4 ft	11	11	11	10	10	9
F2 (Ust)	● 242	232	231	235	232	228	222
	■ 400	395	388	399	392	402	399
F3 (Ust)	● 161	156	156	160	158	156	152
	■ 333	331	324	336	329	339	336

8 ft - ZX 6830

Span (ft)	98	115	131	148	164	180	197
Height (ft)	176.5	160.1	149.3	138.1	132.9	121.7	116.5
Accessories	6.6 ft	1	1	1	1	1	1
	10.9 ft	1	1	0	2	0	2
	16.4 ft	9	8	8	6	7	5
F1 (Ust)	● 154	145	144	145	147	144	141
	■ 178	168	164	163	168	166	162

8 ft - ZY 800

Span (ft)	98	115	131	148	164	180	197
Height (ft)	216.2	199.8	194.2	183.4	177.8	167	167
Accessories	6.6 ft	1	1	1	1	1	1
	10.9 ft	0	0	1	0	1	0
	16.4 ft	12	11	10	10	9	9
F1 (Ust)	● 153	143	147	145	150	145	146
	■ 199	188	195	190	197	190	197

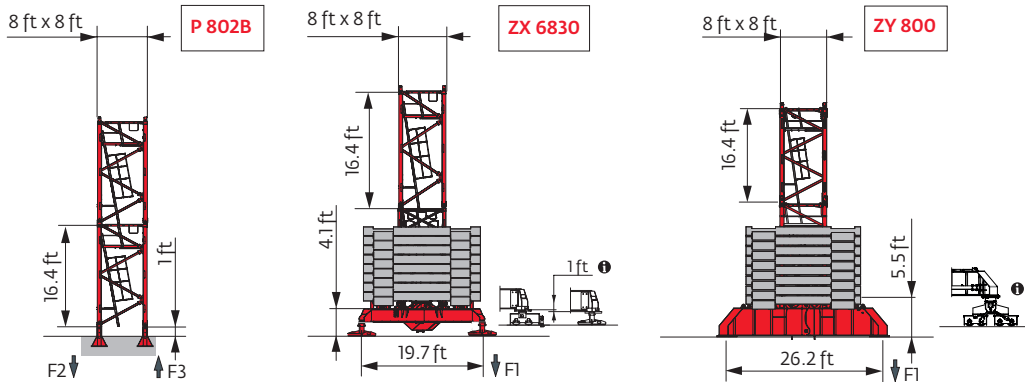

Note: When "ASCE" is noted in this data sheet it is referring to 115 mph Wind Zone, Exposure B, Design Wind Speed = 98 mph. See back cover for design wind speed calculations.

i Motorized accesses: adapted mast compositions, base ballast and reactions.

Anchorage

i

Base ballast

USt) / 6.6 ft - V 60A -

ft)	98	115	131	148	164	180	197
164.7	145.5						
148.3	119.1	145.5					
137.1	119.1	119.1	145.5				
126.3	119.1	119.1	119.1	145.5			
115.5	119.1	119.1	105.8	119.1	145.5		
104.3	119.1	119.1	105.8	105.8	119.1	145.5	
99.1	119.1	119.1	105.8	105.8	105.8	132.3	145.5
82.7	119.1	119.1	105.8	105.8	92.6	105.8	105.8

USt) / 6.6 ft - ZX 6830 -

ft)	98	115	131	148	164	180	197
180.8	177.5						
175.5	166.5	199.5					
159.1	133.4	166.5	188.5				
148	122.4	133.4	166.5	199.5			
137.1	111.3	111.3	144.4	166.5	199.5		
126.3	111.3	111.3	111.3	144.4	166.5	199.5	
120.7	111.3	111.3	111.3	133.4	155.4	177.5	199.5
104.3	111.3	111.3	100.3	100.3	122.4	144.4	155.4
87.9	111.3	111.3	100.3	100.3	100.3	111.3	122.4

USt) / 8 ft - ZX 6830 -

ft)	98	115	131	148	164	180	197
176.5	199.5						
160.1	155.4	188.5					
149.3	133.4	166.5	188.5				
138.1	111.3	133.4	166.5	188.5			
132.9	111.3	122.4	144.4	177.5	199.5		
121.7	111.3	111.3	122.4	144.4	177.5	199.5	
116.5	111.3	111.3	111.3	133.4	155.4	188.5	199.5
100.1	111.3	111.3	100.3	100.3	122.4	144.4	155.4
83.7	111.3	111.3	100.3	100.3	100.3	100.3	111.3

USt) / 8 ft - ZY 800 -

ft)	98	115	131	148	164	180	197
216.2	185.2						
199.8	145.5	172					
194.2	145.5	172	185.2				
183.4	119.1	145.5	172	185.2			
177.8	105.8	132.3	158.7	185.2	198.4		
167	92.6	119.1	132.3	158.7	172	198.4	211.6
150.6	52.9	79.4	105.8	119.1	145.5	158.7	172
134.2	39.7	52.9	79.4	92.6	105.8	132.3	145.5
117.8	39.7	52.9	39.7	66.1	79.4	105.8	105.8
101.4	39.7	52.9	39.7	39.7	52.9	66.1	79.4
85	39.7	52.9	39.7	39.7	39.7	39.7	52.9

Load curves

ft)	49	56	66	72	82	89	98	102	105	115	118	121	131	133	138	148	154	164	165	180	181	197	ft		
13.2 USt																									
197	16 → 90	13.2	13.2	13.2	13.2	13.2	13.2	11.4	-	10.3	8.8	-	7.9	6.8	-	6.2	5.3	4.7	4.1	-	3.1		2.6	USt	
180	16 → 90	13.2	13.2	13.2	13.2	13.2	13.2	11.6	-	10.5	8.9	-	8.2	7.1	-	6.4	5.5	5	4.3	-	3.6	3.6		USt	
164	16 → 91.5	13.2	13.2	13.2	13.2	13.2	13.2	11.8	-	10.7	9.1	-	8.4	7.3	-	6.6	5.6	5.2	4.9	4.7				USt	
148	13 → 93	13.2	13.2	13.2	13.2	13.2	13.2	12.2	-	11	9.5	-	8.7	7.5	-	6.8	6.3	6.2							
131	13 → 94	13.2	13.2	13.2	13.2	13.2	13.2	12.5	-	11.2	9.7	-	8.8	7.9	7.7										
115	13 → 96	13.2	13.2	13.2	13.2	13.2	13.2	12.8	-	11.6	10	9.9													
98	10 → 98	13.2	13.2	13.2	13.2	13.2	13.2	13.2	12.6																

ft)	49	56	66	72	82	89	98	102	105	115	118	121	131	133	138	148	149	154	164	165	180	181	ft		
26.5 USt																									
180	16 → 71	17.6	17.6	17.6	17.3	14.3	12.7	10.7	-	9.5	8	-	7.3	6.2	-	5.5	4.6	-	4.1	3.4	-	2.9	2.9		USt
164	16 → 61	22	22	20	17.4	14.3	12.8	10.7	-	9.6	8.2	-	7.3	6.2	-	5.5	5.3	-	4.7	4	3.9				USt
148	13 → 54	26.5	25.4	20.4	17.9	14.8	13.1	11.1	-	9.9	8.5	-	8.3	7.2	-	6.4	5.4	5.3							
131	13 → 55	26.5	25.7	20.7	18.2	15.1	13.4	11.4	-	10.9	9.4	-	8.5	7.2	6.9										
115	13 → 55	26.5	26	20.9	18.4	15.3	13.7	12.3	-	11.1	9.5	9													
98	10 → 55	26.5	26	21.1	18.5	15.5	14.4	12.2	11.6																

Jib weight & counter-jib ballast

	▲▲▲▲ (lb) (+/- 5%)	180 HPL™		
		8,708 lb	2,205 lb	▲ (lb)
197 ft	20,988	4	1	37,038
180 ft	19,709	4	1	37,038
164 ft	18,508	4	1	37,038
148 ft	17,196	4	0	34,833
131 ft	15,807	4	0	34,833
115 ft	14,065	4	0	34,833
98 ft	12,192	4	0	34,833

CBJ - 8,708 lb

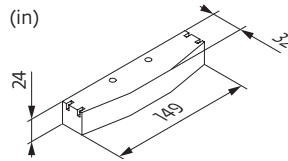

CBK - 2,205 lb

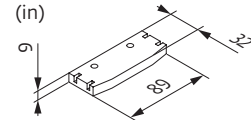

Luffing jib

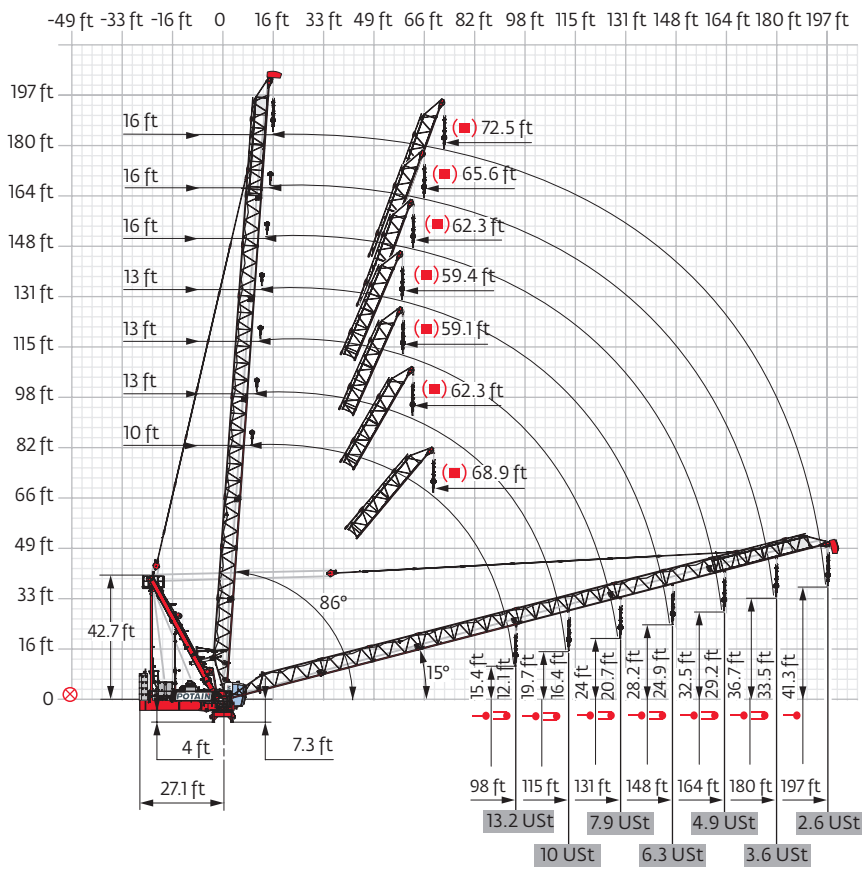





Dimensions and weight

Slewing crane part:  197 ft -  180 HPL™

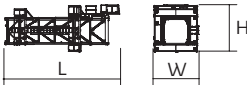

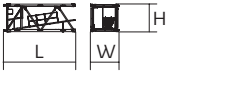
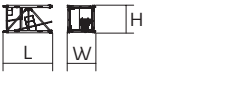
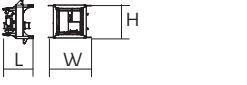
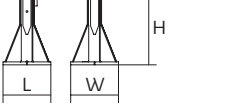
Slewing crane part		L (ft)	W (ft)	H (ft)	lb (+/- 5%)
Counter-jib		25.7	19.6	15.7	16,887
Strut		8.1	7.2	39	18,475
Cab	Ultra View	15.1	7.2	9.6	4,453
Towerhead	6.6 ft	10.2	9.8	10.2	21,275
Jib section	①	33.7	6.2	6.5	3,990
Jib section	② ③ ⑥ ⑦	17 17 17 17	5.9 5.9 5.9 5.9	5.5 5.4 5.4 5.4	1,499 1,631 1,135 1,257
Jib section	④ ⑤	33.4 33.4	5.9 5.9	5.5 5.4	2,910 2,337
Jib section	⑧	38.9	6	6.9	3,197
Pulley block		5.1	1.5	8.2	2,017
Hoisting winch (+ rope)	180 HPL™	16.1	7.4	6.3	23,623
Luffing winch (+ rope)	100 VVF	10.4	5.8	6.2	7,837

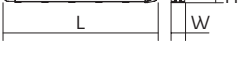
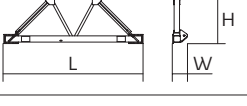
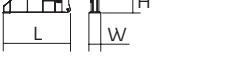
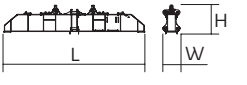
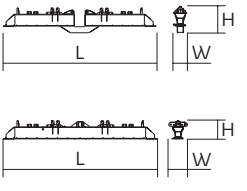
Crane tower			L (ft)	W (ft)	H (ft)	lb (+/- 5%)
T 61 T 851		□ 6.6 ft □ 8 ft	35.5 36.7	13.6 15.9	14.7 19	21,385 34,723
K 649B KM 649E		□ 6.6 ft □ 6.6 ft	33.6 33.8	6.8 6.7	6.7 6.7	11,663 10,692
K 649A KMT 649A KR 649A KRMT 649A K 849A KR 849A KMT 849A KRMT 849A		□ 6.6 ft □ 6.6 ft □ 6.6 ft □ 6.6 ft □ 8 ft □ 8 ft □ 8 ft □ 8 ft	17.2 17.2 17.2 17.2 17.2 17.2 17.2 17.2	6.8 6.8 6.9 6.8 8.3 8.3 8.4 8.3	6.7 6.7 6.8 6.8 8.2 8.2 8.3 8.3	6,184 5,666 7,165 6,724 7,496 9,458 6,945 9,017
K 649C KMT 649C KRMT 649C KRMT 849C		□ 6.6 ft □ 6.6 ft □ 6.6 ft □ 8 ft	11.7 11.7 11.7 11.7	6.8 6.8 6.9 8.4	6.7 6.7 6.8 8.3	4,376 4,542 5,401 7,066
K80/KR60-2 Connecting mast		□ 8/6.6 ft	7.3	10.7	8.1	8,852
Fixing angles		P 602B P 802B	2.1 2.5	2.1 2.5	4.2 4.2	650 1,025
Basic mast unit		V 60A	16.4	7.9	7.9	9,674
Struts		V 60A	14.8	1	1	919
Half-bearer		V 60A	22	2.3	7.6	3,519
1/2 Cross girder		ZY 800	18.6	3.2	6.3	10,406
Cross girder		ZY 800	39.2	4.6	6.3	22,212
Cross girder		ZX 6830	29.9 29.9	2.5 3.7	4.9 3.6	12,004 11,607

Mechanisms

480 V - 60 Hz													hp	kW	
	180 HPL™ 120	fpm	184	226	302	461	689	92	115	153	246	344	180	132	2,044 ft
		USt	13.2	9.9	6.6	3.3	0.9	26.5	19.8	13.2	6.6	3.1			
	100 VVF 40		1 min 40 s									100	75		
	RVF 172 Optima+	rpm	0 → 0.9									2 x 10	2 x 7.5		

IEC 60204-32	kVA
480 V (+6% -10%) 60 Hz	243 → 171 kVA

These mast combinations meet the EN 14439 and ASME B30.3-2016 specifications for “out of service” wind conditions, provided the illustrated wind speed matches required design wind speed for the location of the tower crane. The “out of service” design wind speed was determined in accordance with ASCE 7-10, Figure 26.5-1A. The wind velocity, used for this configuration was 98 mph (158 kph), which represents a nominal design 3-second wind gust at 33 ft (10 m) above ground for Exposure B category. A factor of 0.85 was applied to the 700-year ultimate design wind speed of 115 mph (185 kph), per ASCE 37-02, with the assumption that this crane is considered a temporary structure used during a construction period of 2 years or less.

- Standard equipment
- Options
- Reactions in service
- Reactions out of service
- Jib weight
- Total ballast weight
- Jib articulation axis
- Weather vaning position
- Lorry 44 ft
- Container High Cube 40 ft, and/or Flat Rack 20 ft
- Hoisting
- Luffing
- Slewing
- Travelling
- Required power
- Power Control Function: winch speeds adapted to the available power
- Consult us

This commercial document is not legally binding. For any technical information, please refer to the corresponding instructions.

