

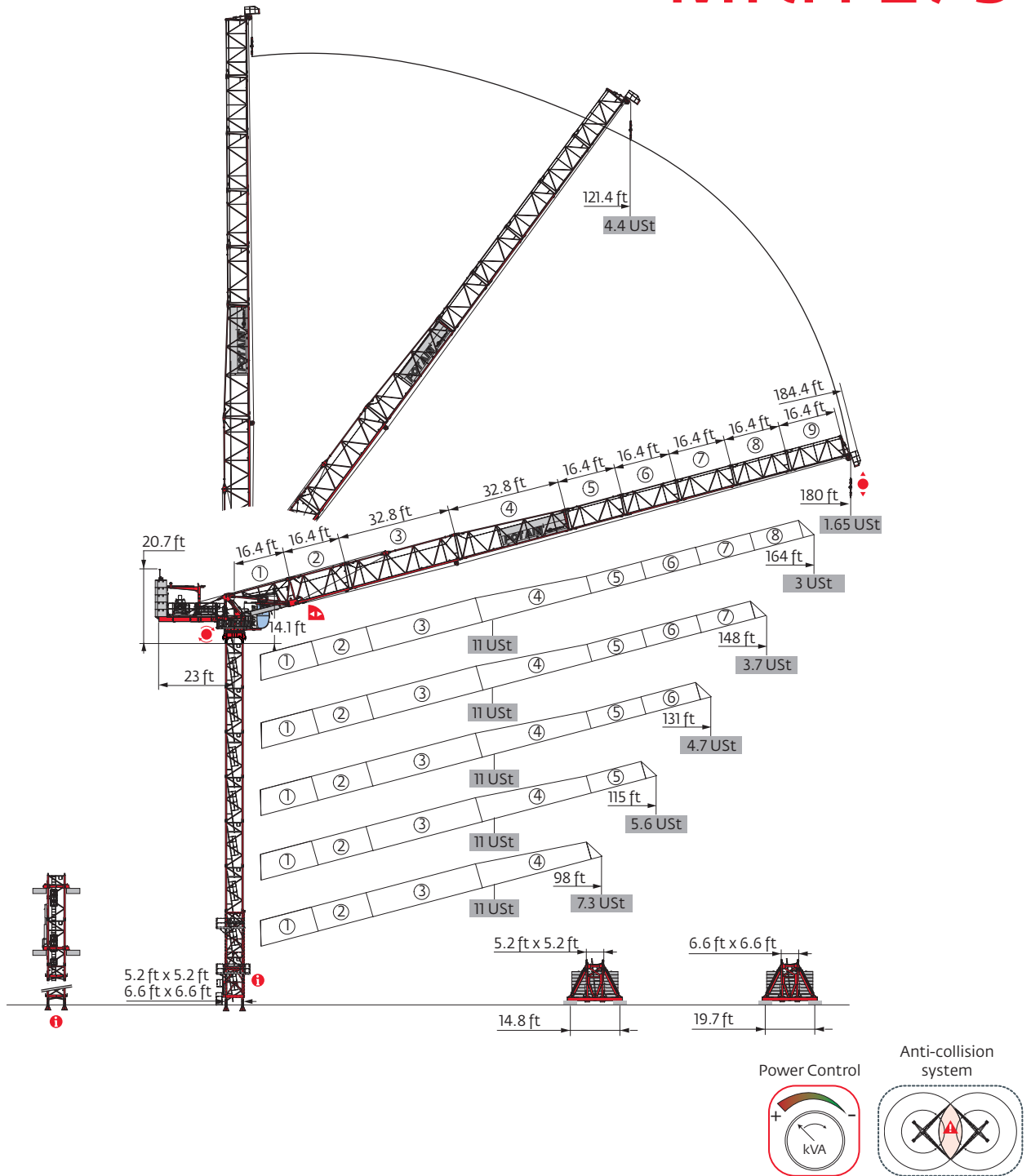

MRH 175



Mast - Reactions

5.2 ft - P 41A							
Height (ft)	98	115	131	148	164	180	
Height (ft)	118.8	113.2	96.8	96.8	96.8	91.5	
10.9 ft	2	0	0	0	0	1	
16.4 ft	5	6	5	5	5	4	
F2 (Ust)	● 157	156	151	157	164	156	
	■ 141	144	127	145	160	164	
F3 (Ust)	● 117	117	107	112	119	117	
	■ 102	105	89	105	120	126	

5.2 ft - S 41A - 							
Height (ft)	98	115	131	148	164	180	
Height (ft)	129.3	123.7	107.3	107.3	90.9	96.5	
10.9 ft	2	0	0	0	0	2	
16.4 ft	5	6	5	5	4	3	
F1 (Ust)	● 97	98	95	99	96	97	
	■ 93	94	86	94	86	98	

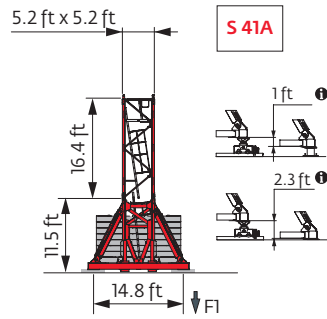
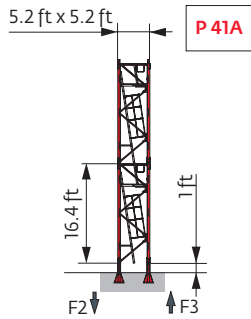

 Motorized accesses: adapted mast compositions, base ballast and reactions.

Note: When "ASCE" is noted in this data sheet it is referring to 115 mph Wind Zone, Exposure B, Design Wind Speed = 98 mph. See back cover for design wind speed calculations.

6.6 ft - P 602B						
Height (ft)	98	115	131	148	164	180
Height (ft)	211.6	200.8	195.2	190	184.4	178.8
10.9 ft	0	2	0	1	2	0
16.4 ft	12	10	11	10	9	10
F2 (Ust)	● 185	182	184	187	190	179
	■ 350	340	342	347	349	349
F3 (Ust)	● 133	125	128	130	134	129
	■ 298	289	291	296	298	299

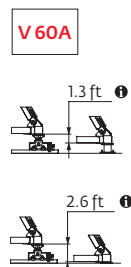
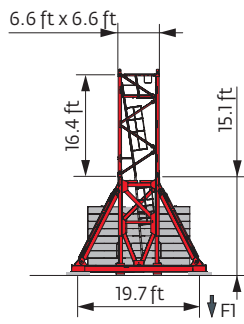
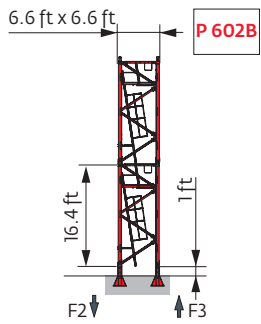

6.6 ft - V 60A						
Height (ft)	98	115	131	148	164	180
Height (ft)	182.1	176.5	165.7	160.1	149.3	143.7
10.9 ft	2	0	2	0	2	0
16.4 ft	8	9	7	8	6	7
F1 (Ust)	● 105	107	106	107	107	101
	■ 139	140	135	137	131	131





Anchorage



Base ballast

 (USt) / 5.2 ft - S 41A - 



Span (ft)	98	115	131	148	164	180
129.3	119.1					
123.7	112.4	119.1				
107.3	105.8	105.8	112.4	119.1		
 (ft)	96.5	99.2	99.2	-	-	125.7
90.9	92.6	99.2	105.8	105.8	112.4	119.1
74.5	79.4	86	92.6	92.6	99.2	105.8
58.1	72.8	72.8	79.4	86	92.6	99.2
41.7	59.5	66.1	72.8	72.8	79.4	86

 (USt) / 6.6 ft - V 60A - 

Span (ft)	98	115	131	148	164	180
182.1	145.5					
176.5	132.3	145.5				
165.7	119.1	132.3	145.5			
 (ft)	160.1	105.8	119.1	132.3	145.5	
149.3	79.4	92.6	105.8	132.3	145.5	
143.7	79.4	79.4	105.8	119.1	132.3	145.5
127.3	66.1	79.4	79.4	92.6	105.8	119.1
110.9	66.1	66.1	66.1	79.4	79.4	79.4
94.5	52.9	52.9	66.1	66.1	66.1	79.4
78.1	39.7	52.9	52.9	52.9	66.1	66.1
61.7	39.7	39.7	39.7	52.9	52.9	52.9
45.3	26.5	39.7	39.7	39.7	39.7	52.9

Load curves



Span (ft)	56	66	72	82	89	98	99.5	105	115	115.6	121	131	131.8	138	148	154	164	ft			
 USt																					
 5.5 USt																					
164	15.1 → 73.6	114.3 - 116.8		11	11	11	9.4	8.4	7.1	-	6.4	5.5	-	5.1	4.4	-	4	3.5	3.1	2.7	USt
148	14.1 → 73	113.5 - 115.9		11	11	11	9.3	8.3	7	-	6.3	5.5	-	5.1	4.4	-	4	3.4	USt		
131	13.5 → 73.2	114.1 - 116.5		11	11	11	9.4	8.4	7.1	-	6.4	5.5	-	5.1	4.4	4.4	USt				
115	12.5 → 73.6	115.6 - 115.6		11	11	11	9.5	8.5	7.2	-	6.5	5.6	5.5	USt							
98	11.5 → 73.7			11	11	11	9.5	8.5	7.3	7.2	USt										

 =  - 0.21 USt max.



Span (ft)	56	66	72	82	89	98	99.5	105	115	115.6	121	131	131.8	138	148	154	164	171	180	ft	
 5.5 USt																					
180	16.1 → 121.4		4.4	4.4	4.4	4.4	4.4	4.4	4.4	4.4	4.4	4.4	3.8	-	3.4	2.9	2.6	2.2	1.95	1.65	USt
164	15.1 → 120.1		5.5	5.5	5.5	5.5	5.5	5.5	5.5	5.5	5.5	5.4	4.7	-	4.3	3.7	3.4	3	USt		
148	14.1 → 119.3		5.5	5.5	5.5	5.5	5.5	5.5	5.5	5.5	5.5	5.3	4.7	-	4.2	3.7	USt				
131	13.5 → 120		5.5	5.5	5.5	5.5	5.5	5.5	5.5	5.5	5.5	5.4	4.7	4.7	USt						
115	12.5 → 115.6		5.5	5.5	5.5	5.5	5.5	5.5	5.5	5.5	5.5	5.5	USt								
98	11.5 → 99.5		5.5	5.5	5.5	5.5	5.5	5.5	5.5	USt											

Jib weight & counter-jib ballast

Height (ft)	Jib Weight (lb) (+/- 5%)		Counter-jib Ballast (lb)	Total Weight (lb)
	②	⑨		
180 ft	16,403	-	5	52,360
164 ft	15,731	16,128	5	52,360
148 ft	14,948	15,345	5	52,360
131 ft	14,000	14,397	5	52,360
115 ft	12,821	13,218	5	52,360
98 ft	11,465	11,862	5	52,360

CCL - 10,472 lb

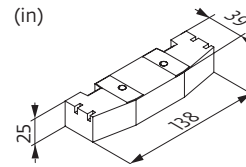



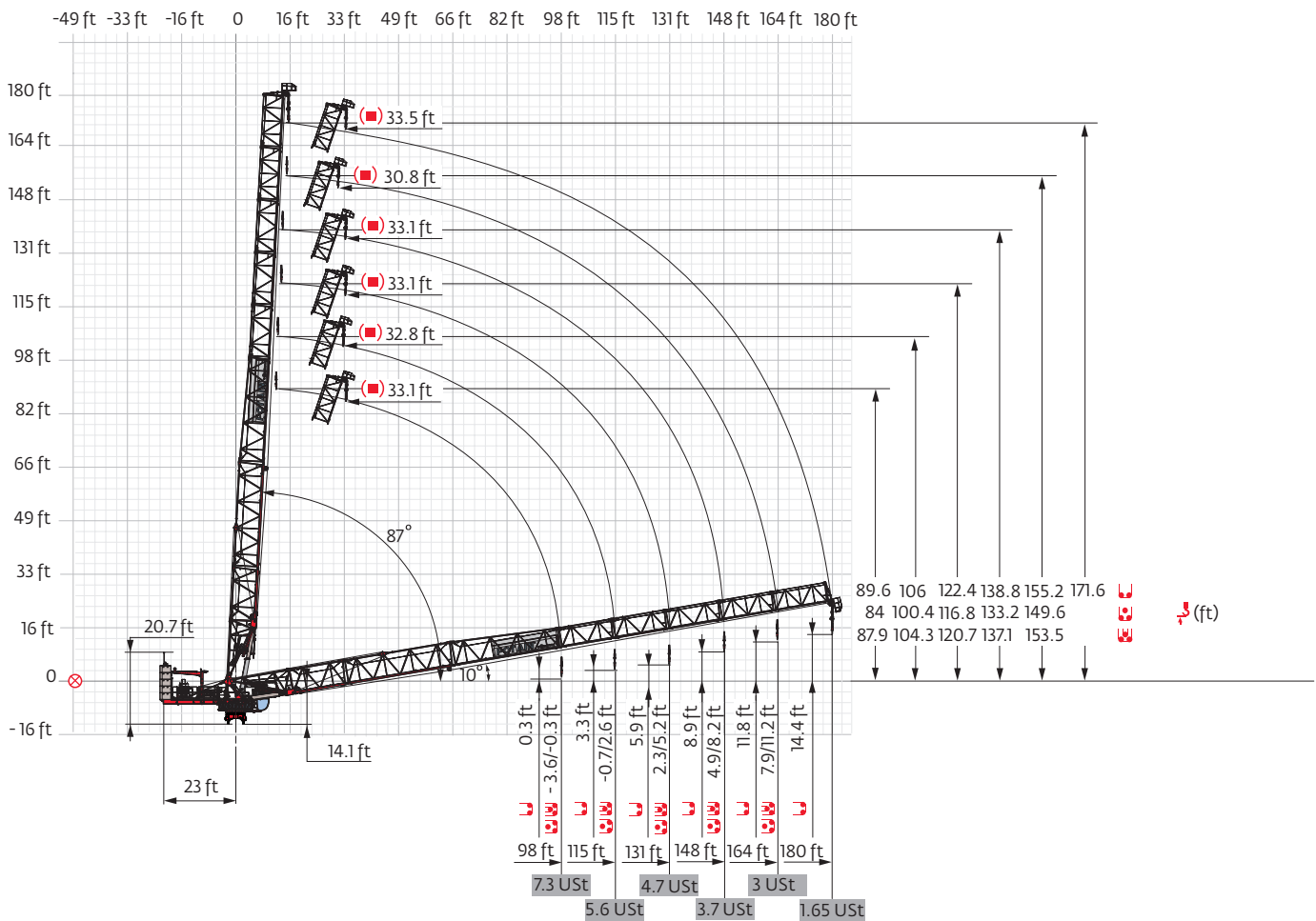



Luffing jib



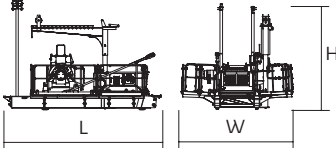
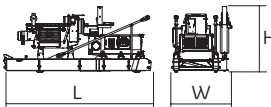
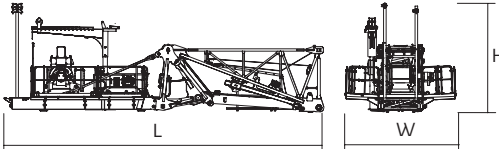
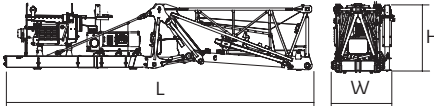

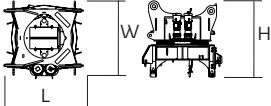
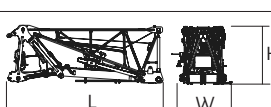
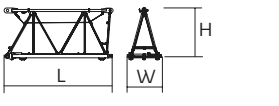
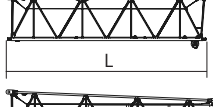

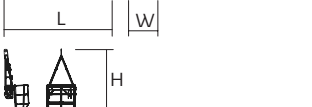
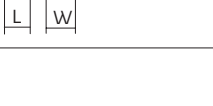

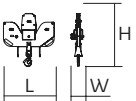

Dimensions and weight

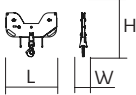
Slewing crane part:  180 ft -  50 LVF

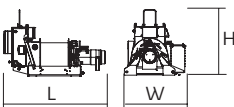

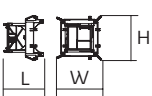
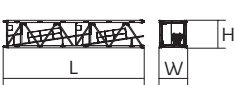
Slewing crane part		L (ft)	W (ft)	H (ft)	lb (+/- 5%)	
Counter-jib		50 LVF 90 HPL™	19.7	13.9	13.1	15,399 17,780
		50 LVF 90 HPL™	18.2	7.4	10	14,099 16,480
Counter-jib + Jib foot		50 LVF 90 HPL™	40	13.9	13.1	32,187 34,568
		50 LVF 90 HPL™	39.4	7.4	8.4	30,887 33,268
Cab		V140 SR	15.9	7.8	8.2	3748
Towerhead		□ 5.2 ft	7.1	6.6	7.8	10,891
		□ 6.6 ft	8.2	8.1	7.8	13,922
Jib section		①	21.6	7.1	8.4	16,788
		②	17.4	5.6	8.2	3,164
		③	33	4.7	8.2	4,068
		④	33.6	4.7	7.8	3,395
		⑤	17.1	4.7	6.4	1,356
		⑥	17	4.7	6.4	1,179
		⑦	16.9	4.7	6.4	948
		⑧	16.9	4.5	6.3	783
		⑨	16.9	4.5	6.3	672
			4	4.9	10	397

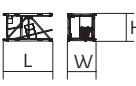
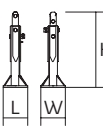
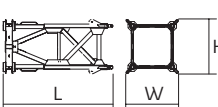
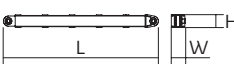
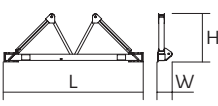
Pulley block			4.8	1.2	4.9	838
			4.8	0.7	4.1	441
Hoisting winch (+ rope)		50 LVF 90 HPL™	8.2 9.3	5 4.3	5.3 5.6	4,365 6,746
Crane tower			L (ft)	W (ft)	H (ft)	lb (+/- 5%)
T61		□ 6.6 ft	35.5	13.6	14.7	21,385
K60/K40-2		□ 6.6/5.2 ft	7.3	8.2	8.1	5,820
K 447E KM 447E KM 449E K 649B KM 649E		□ 5.2 ft □ 5.2 ft □ 5.2 ft □ 6.6 ft □ 6.6 ft	33.5 33.5 33.5 33.6 33.8	5.3 5.3 5.3 6.8 6.7	5.3 5.3 5.3 6.7 6.7	7,474 7,088 8,448 11,663 10,692
K 447A KMT 447A K 449A KMT 449A KR 649A KRMT 649A K 649A KMT 649A		□ 5.2 ft □ 5.2 ft □ 5.2 ft □ 5.2 ft □ 6.6 ft □ 6.6 ft □ 6.6 ft □ 6.6 ft	17.1 17.1 17.1 17.1 17.2 17.2 17.2 17.2	5.5 5.5 5.5 5.5 6.9 6.9 6.8 6.8	5.3 5.3 5.3 5.3 6.8 6.8 6.7 6.7	4,079 3,847 4,916 4,696 7,165 6,724 6,184 5,666
K 447C K 649C KMT 649C KRMT 649C		□ 5.2 ft □ 6.6 ft □ 6.6 ft □ 6.6 ft	11.3 11.7 11.7 11.7	5.5 6.8 6.8 6.9	5.3 6.7 6.7 6.8	2,998 4,376 4,542 5,401
Fixing angles		P 41A P 602B	1.2 2.1	1.2 2.1	3.7 4.2	293 650
Basic mast unit		S 41A V 60A	11.9 16.4	6.4 7.9	6.8 7.9	6,537 9,674
Struts		S 41A V 60A	10.4 14.8	0.9 1	0.8 1	489 919
Half-bearer		S 41A V 60A	16.7 22	2 2.3	5.8 7.6	2,524 3,519

Mechanisms

480 V - 60 Hz										hp	kW				
	50 LVF 25 Optima	fpm	126	166	221	313	66	85	115	157	50	37	1,827 ft		
		USt	5.5	4.1	2.8	1.1	11	8.3	5.5	2.5					
	90 HPL™ 25	fpm	213	279	392	518	707	110	146	203	271	353	90	66	3,136 ft
		USt	5.5	4.1	2.8	1.4	0.4	11	8.3	5.5	2.8	1.3			
	60 VVH 140	min	2								60	45			
	RVF 152 Optima +	rpm	0 → 0.8								2 x 5.5	2 x 4			

	IEC 60204-32	kVA
480 V (+6% -10%) 60 Hz	50 LVF: 107 kVA 90 HPL™: 139 → 103 kVA	

50 LVF 25 Optima

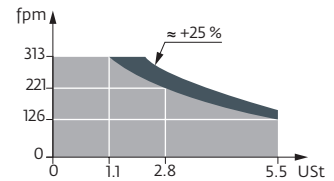

These most combinations meet the EN 14439 and ASME B30.3-2016 specifications for "out of service" wind conditions, provided the illustrated wind speed matches required design wind speed for the location of the tower crane. The "out of service" design wind speed was determined in accordance with ASCE 7-10, Figure 26.5-1A. The wind velocity, used for this configuration was 98 mph (158 kph), which represents a nominal design 3-second wind gust at 33 ft (10 m) above ground for Exposure B category. A factor of 0.85 was applied to the 700-year ultimate design wind speed of 115 mph (185 kph), per ASCE 37-02, with the assumption that this crane is considered a temporary structure used during a construction period of 2 years or less.

- Standard equipment
- Options
- Weathering position
- Lorry 44 ft
- Reactions in service
- Container High Cube 40 ft, and/or Flat Rack 20 ft
- Reactions out of service
- Hoisting
- Required power
- Jib weight
- Luffing
- Power Control Function: winch speeds adapted to the available power
- Total ballast weight
- Slewing
- Consult us
- Jib articulation axis
- Travelling

This commercial document is not legally binding. For any technical information, please refer to the corresponding instructions.

