

MDT 219 J8

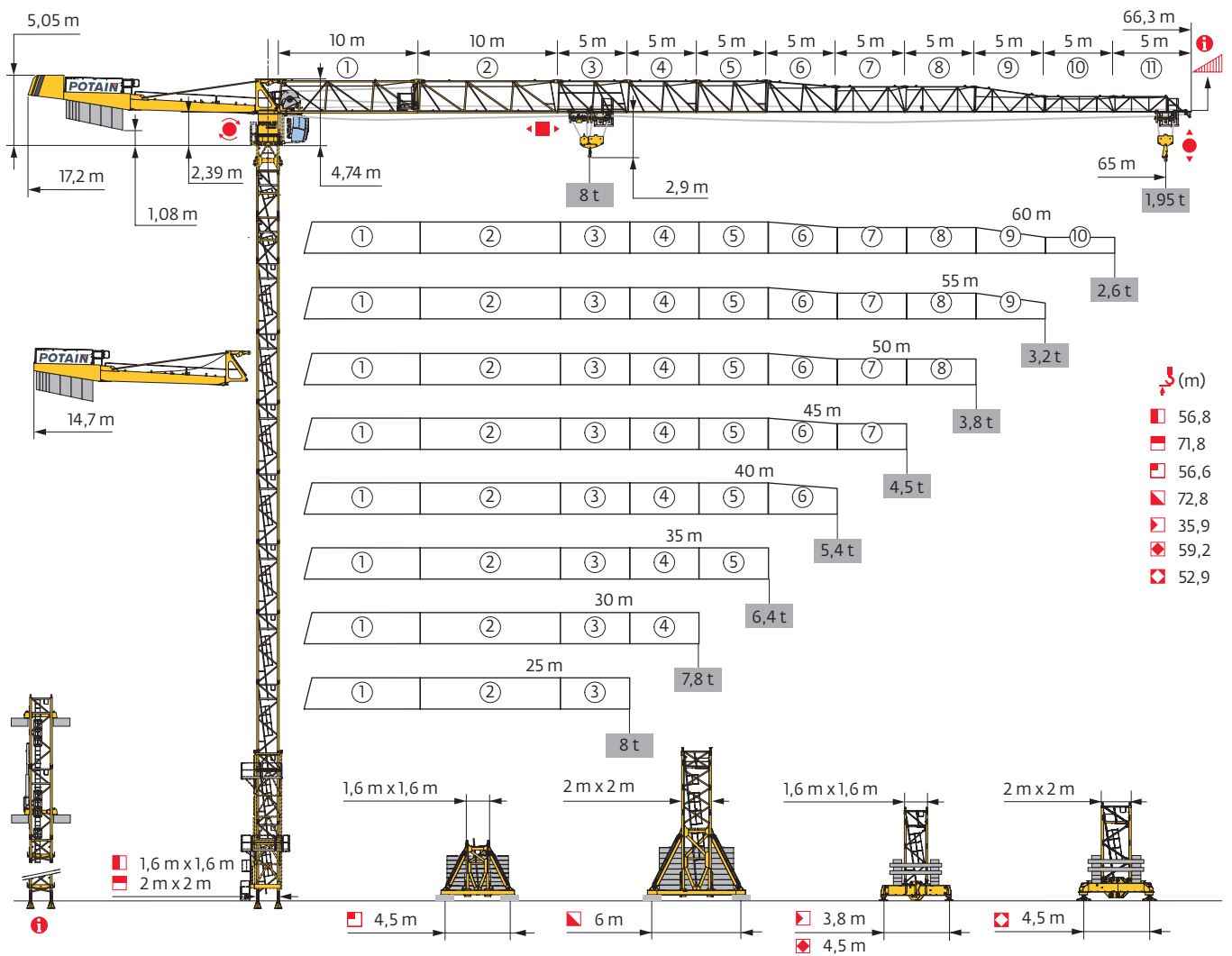

Potain Plus Power Control Top Site Top Tracing 3

Mât - Réactions / Mast - Reaktionskräfte / Mast - Reactions / Mástil - Reacciones / Torre - Reazioni
 Tramo - Reacções / Реакция опор мачты

1,6 m City - ZC 4230 -

AVAIL (m)	25	30	35	40	45	50	55	60	65
↓ (m)	35,9	24,2	30,9	32,5	34,2	35,9	35,9	35,9	35,9
↓/P+ (m)	35,9	-	-	-	-	32,5	32,5	32,5	30,9
3,33 m	0	1	0	2	1	0	0	0	0
	5 m	7	4	6	5	6	7	7	7
F1 (t)	● 67	64	67	69	70	71	71	71	72
	■ 52	53	53	53	53	54	57	59	62

1,6 m City - ZD 4230 -

AVAIL (m)	25	30	35	40	45	50	55	60	65
↓ (m)	54,2	52,5	54,2	52,5	52,5	52,5	50,9	50,9	49,2
↓/P+ (m)	54,2	44,2	45,9	45,9	47,5	52,5	50,9	50,9	49,2
3,33 m	1	2	1	2	2	2	0	0	1
	5 m	10	9	10	9	9	10	10	9
F1 (t)	● 75	76	77	77	76	79	78	79	78
	■ 88	83	89	86	86	88	83	88	87

1,6 m City - ZD 463 -

AVAIL (m)	25	30	35	40	45	50	55	60	65
↓ (m)	59,2	55,9	55,9	55,9	55,9	55,9	55,9	55,9	54,2
↓/P+ (m)	59,2	49,2	49,2	49,2	49,2	54,2	50,9	50,9	50,9
3,33 m	1	0	0	0	0	0	0	0	1
	5 m	11	11	11	11	11	11	11	10
F1 (t)	● 88	79	81	82	83	84	86	88	87
	■ 110	93	95	96	98	98	103	108	107

1,6 m - P 41A

AVAIL (m)	25	30	35	40	45	50	55	60	65
↓ (m)	56,8	56,8	56,8	56,8	55,1	55,1	53,5	51,8	51,8
↓/P+ (m)	56,8	51,8	51,8	51,8	51,8	55,1	53,5	51,8	51,8
2 m	1	1	1	1	1	1	1	1	1
	3,33 m	0	0	0	0	1	1	2	0
5 m	11	11	11	11	10	10	9	10	10
	F2 (t)	● 138	142	142	144	143	146	147	145
■ 174		174	176	179	173	175	173	167	174
F3 (t)	● 102	104	104	105	104	106	107	105	106
	■ 142	140	142	144	138	139	137	132	139

1,6 m - S 41A -

AVAIL (m)	25	30	35	40	45	50	55	60	65
↓ (m)	56,6	56,6	56,6	56,6	56,6	56,6	56,6	55	53,3
↓/P+ (m)	56,6	50	50	50	50	55	55	53,3	51,6
2 m	1	1	1	1	1	1	1	1	1
	3,33 m	2	2	2	2	2	2	0	1
5 m	9	9	9	9	9	9	9	10	9
	F1 (t)	● 88	88	88	89	90	91	94	91
■ 110		109	110	112	113	114	119	114	114

1,6 m - ZD 4230 -

AVAIL (m)	25	30	35	40	45	50	55	60	65
↓ (m)	51,2	49,5	51,2	51,2	49,5	49,5	47,9	47,9	46,2
↓/P+ (m)	51,2	39,5	39,5	42,9	44,5	49,5	47,9	47,9	46,2
2 m	1	1	1	1	1	1	1	1	1
	3,33 m	1	2	1	1	2	2	0	1
5 m	9	8	9	9	8	8	9	9	8
	F1 (t)	● 74	75	76	77	75	78	77	77
■ 88		82	88	90	85	87	83	87	87

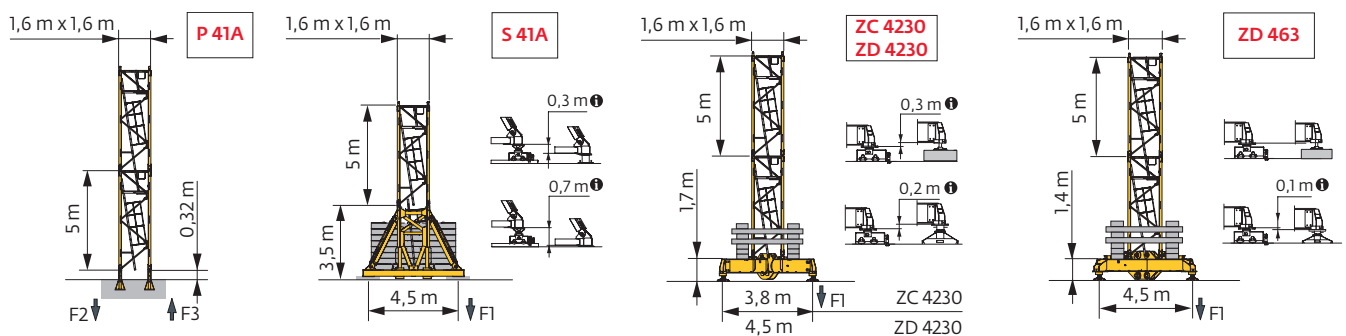

i Accès motorisés : compositions de mât, de lest de base et réactions adaptées. / Motorisierter Zugang vom : Mastzusammensetzung, Grundballast und Reaktionskräfte sind angepasst. / Motorized accesses: adapted mast composition, base ballast and reactions. / Acceso a cabina con elevador: Adaptación de composición de mástil, lastre de base y reacciones. / Accessi motorizzati: composizioni elementi torre, zavorre di base e reazioni aggiornate. / Acessos motorizados: composições de coluna, lastro da base e reacções adaptadas. / Лифты : адаптированная композиция мачты, базовый балласт и нагрузки.

2 m - P 62B

ΔΔΔ (m)	25	30	35	40	45	50	55	60	65
↓ (m)	71,8	71,8	71,8	71,8	70,1	70,1	70,1	68,5	68,5
↓/P+ (m)	71,8	71,8	71,8	71,8	70,1	70,1	70,1	68,5	68,5
	2 m	1	1	1	1	1	1	1	1
	3,33 m	0	0	0	1	1	1	2	2
	5 m	14	14	14	14	13	13	13	12
F2 (t)	● 156	162	163	165	163	162	167	165	166
	■ 277	277	279	281	272	274	279	274	280
F3 (t)	● 112	117	117	118	116	115	119	117	118
	■ 237	236	237	239	229	230	235	230	235

2 m - V 60A -

ΔΔΔ (m)	25	30	35	40	45	50	55	60	65
↓ (m)	64,4	66,1	66,1	66,1	66,1	66,1	64,4	64,4	62,8
↓/P+ (m)	64,4	66,1	66,1	66,1	66,1	66,1	64,4	64,4	62,8
	2 m	1	1	1	1	1	1	1	1
	3,33 m	1	0	0	0	0	1	1	2
	5 m	11	12	12	12	12	12	11	10
F1 (t)	● 93	96	97	97	98	98	98	99	98
	■ 131	137	138	139	140	141	138	141	138

2 m - V 63A -

ΔΔΔ (m)	25	30	35	40	45	50	55	60	65
↓ (m)	72,8	72,8	72,8	72,8	72,8	72,8	72,8	71,1	71,1
↓/P+ (m)	72,8	72,8	72,8	72,8	72,8	72,8	72,8	71,1	71,1
	2 m	1	1	1	1	1	1	1	1
	3,33 m	2	2	2	2	2	2	0	0
	5 m	11	11	11	11	11	11	12	12
F1 (t)	● 112	114	115	116	117	117	119	117	118
	■ 171	170	171	173	174	174	178	173	176

2 m - ZD 463 -

ΔΔΔ (m)	25	30	35	40	45	50	55	60	65
↓ (m)	52,9	52,9	52,9	52,9	52,9	52,9	51,2	49,5	49,5
↓/P+ (m)	52,9	52,9	52,9	52,9	52,9	52,9	51,2	49,5	49,5
	2 m	1	1	1	1	1	1	1	1
	3,33 m	0	0	0	0	0	1	2	2
	5 m	10	10	10	10	10	10	9	8
F1 (t)	● 91	94	95	95	95	94	93	93	94
	■ 119	118	120	121	122	123	120	118	123

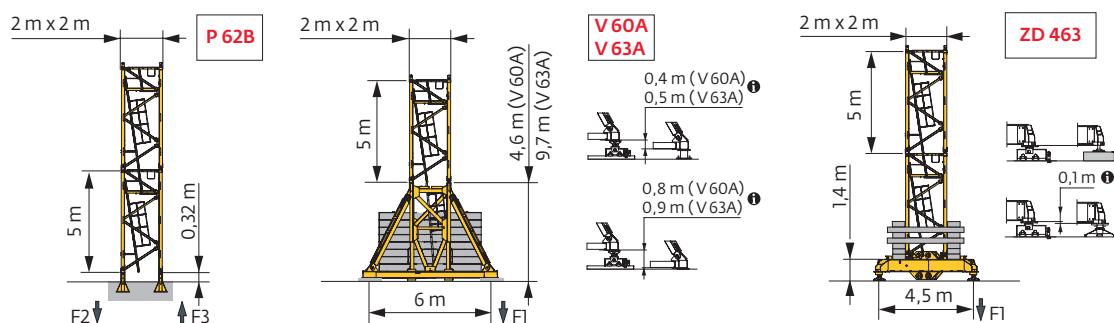

Ancrages / Verankerungen / Anchorages / Anclajes / Ancoraggi
Ancoragem / крепления

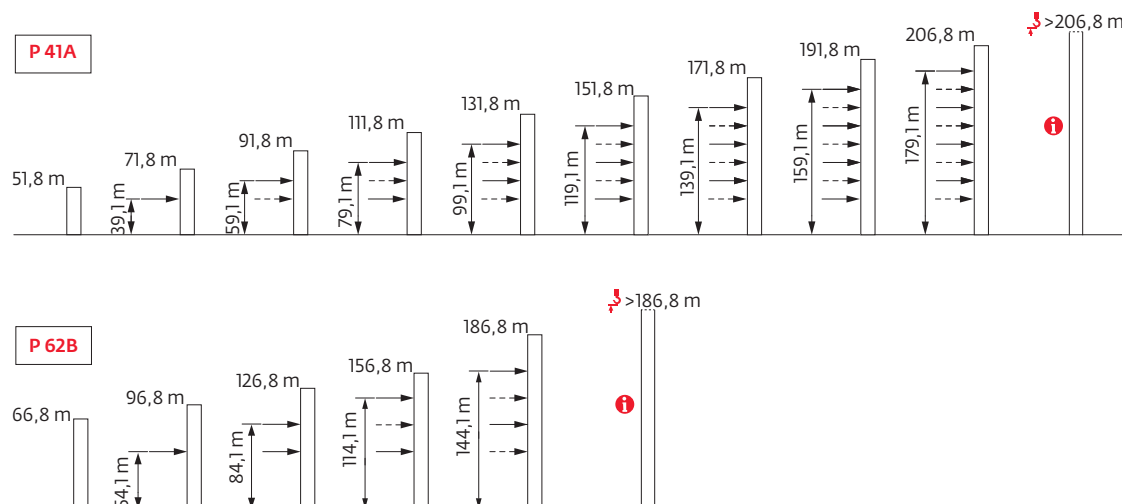

Lest de base / Grundballast / Base ballast / Lastre de base / Zavorra di base
 Lastro da base / Базовый Балласт

⚖️ (t) / 1,6 m City - ZC 4230 - 🚧

ΔΔΔ (m)	25	30	35	40	45	50	55	60	65
35,9	80					80	80	80	80
34,2	80				80	80	80	80	80
32,5	80			80	80	80	80	80	80
30,9	80		80	80	80	80	80	80	80
24,2	80	80	80	80	80	80	80	80	80
19,2	80	80	80	80	80	80	80	80	80

⚖️ (t) / 1,6 m City - ZD 463 - 🚧

ΔΔΔ (m)	25	30	35	40	45	50	55	60	65
59,2	115								
55,9	90	85	90	90	90	90	95	100	
54,2	85	85	80	80	80	85	85	95	100
49,2	70	90	85	85	85	75	75	75	75
44,2	65	85	80	80	75	70	70	65	65
39,2	60	80	75	75	75	65	65	65	60
34,2	55	80	75	75	70	55	55	55	55
29,2	55	80	75	75	70	55	55	50	50
24,2	55	80	75	75	70	55	55	50	50

⚖️ (t) / 1,6 m - ZD 4230 - 🚧

ΔΔΔ (m)	25	30	35	40	45	50	55	60	65
51,2	85		85	85					
49,5	85	85	85	85	80	85			
47,9	80	85	85	80	80	80	80	80	
46,2	80	85	80	80	80	80	80	75	75
41,2	70	75	75	85	85	70	70	70	70
36,2	70	85	80	80	75	70	70	70	70
31,2	70	75	75	70	70	70	70	70	70
26,2	70	75	70	70	70	70	70	70	70
21,2	70	75	70	70	70	70	70	70	70

⚖️ (t) / 2 m - V 63A - 🚧

ΔΔΔ (m)	25	30	35	40	45	50	55	60	65
72,8	180	180	180	180	180	180	180		
71,1	168	168	168	168	168	168	180	180	180
66,1	144	144	144	144	144	144	144	144	156
61,1	108	108	108	108	108	108	120	120	120
56,1	84	84	84	84	84	84	84	96	96
51,1	60	60	60	60	60	60	60	72	72
46,1	36	36	36	36	36	36	36	48	48
41,1	24	36	36	24	24	24	24	24	36
36,1	24	36	36	24	24	24	24	24	24
31,1	24	36	36	24	24	24	24	24	24
26,1	24	36	36	24	24	24	24	24	24

⚖️ (t) / 1,6 m City - ZD 4230 - 🚧

ΔΔΔ (m)	25	30	35	40	45	50	55	60	65
54,2	85		85						
52,5	80	85	85	85	80	85			
50,9	80	85	80	80	80	80	80	80	
49,2	75	80	80	80	80	80	80	75	75
44,2	70	85	85	85	80	75	75	70	70
39,2	65	85	80	80	80	70	70	70	65
34,2	55	80	75	75	70	60	60	60	60
29,2	55	75	75	70	70	55	55	55	55
24,2	55	75	75	70	65	55	50	50	55

⚖️ (t) / 1,6 m - S 41A - 🚧

ΔΔΔ (m)	25	30	35	40	45	50	55	60	65
56,6	114	108	108	108	108	108	114		
55	96	96	96	96	96	96	102	108	
53,3	90	90	90	90	90	90	96	102	108
48,3	72	90	90	84	84	72	72	78	84
43,3	66	84	84	78	78	66	66	66	66
38,3	54	78	78	78	72	60	60	60	60
33,3	48	72	72	66	66	54	54	54	54
28,3	48	72	66	66	60	48	48	48	48
23,3	48	72	66	66	60	48	48	42	48

⚖️ (t) / 2 m - V 60A - 🚧

ΔΔΔ (m)	25	30	35	40	45	50	55	60	65
66,1		132	132	132	132	132			
64,4	132	132	132	132	132	132	132	132	
62,8	120	120	120	120	120	120	120	132	132
57,8	96	96	96	96	96	96	96	96	108
52,8	72	60	60	60	60	60	72	72	84
47,8	48	48	48	48	48	48	48	48	60
42,8	24	36	36	36	24	24	24	24	36
37,8	24	36	36	36	24	24	24	24	24
32,8	24	36	36	36	24	24	24	24	24
27,8	24	36	36	36	24	24	24	24	24
22,8	24	36	36	36	24	24	24	24	24

⚖️ (t) / 2 m - ZD 463 - 🚧

ΔΔΔ (m)	25	30	35	40	45	50	55	60	65
52,9	125	120	120	120	120	120			
51,2	110	110	110	110	110	110	115		
49,5	100	100	100	100	100	100	105	115	120
44,5	70	80	75	75	70	65	75	80	85
39,5	50	75	75	70	65	55	55	55	55
34,5	50	75	75	70	65	55	50	50	55
29,5	50	75	75	70	65	55	50	50	50
24,5	50	75	75	70	65	55	50	50	50

Courbes de charges / Lastkurven / Load curves / Curvas de cargas / Curve di carico
 Curvas de carga / Кривые нагрузок



(m)			17	20	22	25	27	30	32	35	37	40	42	45	47	50	52	55	57	60	62	65	m	
	8 t	4 t																						
	2,9 → 20,1 2,9 → 22	36,7 - 39,3 37,2 - 40	8 8	7,3 6,3	5,8 5,2	4,8 4,3	4 3,9	3,7 3,3	3,1 2,9	2,75 2,55	2,4 2,2	2,05 1,95	t	8 8	8 6,9	6,2 5,4	4,9 4,4	4 4	3,7 3,4	3,2 3	2,85 2,65	2,5 2,35	2,15 1,95	t P+
	2,9 → 21,8 2,9 → 23,2	39,3 - 42 39,6 - 42,2	8 8	7,9 6,9	6,3 5,6	5,2 4,7	4,3 4	4 4	3,7 3,5	3,2 3,1	2,9 2,75	2,6 t	8 8	8 7,4	6,7 5,9	5,3 4,8	4,4 4	4 3,7	3,5 3,3	3,1 2,9	2,75 2,6	t P+		
	2,9 → 23,4 2,9 → 24,5	41,8 - 44,5 42,1 - 45,1	8 8	8 7,4	6,8 6,1	5,6 5,1	4,7 4,3	4 3,9	3,7 3,5	3,3 3,1	t	8 8	8 7,8	7,2 6,3	5,8 5,2	4,7 4,3	4 4	3,8 3,5	3,3 3,2	t P+				
	2,9 → 24,9 2,9 → 25,6	44,6 - 47 44,9 - 48	8 8	8 7,9	7,3 6,5	6 5,5	5,1 4,6	4,3 4	4 4	3,8 t	8 8	8 7,6	6,7 6,2	5,6 5,1	4,7 4,4	4 4	3,8 t P+							
	2,9 → 25,2 2,9 → 27,4		8 8	8 7,4	6,6 6,1	5,5 5,2	4,7 4,5	4,1 t	8 8	8 7,2	6,7 6,1	5,6 5,1	4,7 4,4	t P+										
	2,9 → 25,6 2,9 → 27,9		8 8	8 7,5	6,7 6,2	5,6 5,3	4,8 t	8 8	8 7,4	6,9 6,2	5,8 5,3	t P+												
	2,9 → 26 2,9 → 28,3		8 8	8 7,7	6,8 6,3	5,7 t	8 8	8 7,5	7 6,3	t P+														
	2,9 → 26,4 2,9 → 28,8		8 8	8 7,8	7 t	8 8	8 7,7	t P+	$W_{\text{max}} = W_{\text{min}} - 0,38 \text{ t max.}$															
	2,9 → 25 2,9 → 25		8 8	8 8	t	8 8	8 8	t P+																



(m)			17	20	22	25	27	30	32	35	37	40	42	45	47	50	52	55	57	60	62	65	m	
	8 t	4 t																						
	2,3 → 20,4 2,3 → 22,2	37,3 - 38,1 37,7 - 38,3	8 8	7,4 6,4	5,9 5,2	4,9 4,3	4 3,7	3,5 3,2	3 2,75	2,55 2,35	2,25 2,05	1,85 1,75	t	8 8	8 7	6,3 5,5	5 4,4	4,1 3,8	3,6 3,3	3,1 2,85	2,7 2,5	2,35 2,15	2 1,8	t P+
	2,3 → 22 2,3 → 23,5	40 - 40,3 40,3 - 41	8 8	8 7,4	6,8 5,9	5,4 4,8	4,5 4	3,9	3,6 3,3	3,1 2,95	2,75 2,6	2,45 t	8 8	8 7,4	6,8 5,9	5,4 4,8	4,5 4	3,9 3,6	3,3 3,1	2,95 2,75	2,6 2,45	t P+		
	2,3 → 23,7 2,3 → 24,7	42,4 - 43 42,7 - 43,5	8 8	8 7,5	6,9 6,2	5,7 5,2	4,8 4,4	4,1 3,8	3,5 3,3	3,1 2,9	t	8 8	8 7,9	7,3 6,4	5,9 5,2	4,8 4,4	4,1 3,9	3,6 3,3	3,2 3	t P+				
	2,3 → 25,1 2,3 → 25,9	45,3 - 46 45,6 - 46	8 8	8 7,4	6,6 6,1	5,5 5,2	4,7 4,4	4 3,9	3,6 t	8 8	8 7,6	6,8 6,3	5,7 5,2	4,8 4,4	4,1 3,9	3,7 t P+								
	2,3 → 25,4 2,3 → 27,7		8 8	8 7,5	6,7 6,2	5,6 5,3	4,8 4,6	4,2 t	8 8	8 7,3	6,8 6,2	5,7 5,2	4,8 4,5	t P+										
	2,3 → 25,8 2,3 → 28,2		8 8	8 7,6	6,8 6,3	5,7 5,4	4,9 t	8 8	8 7,5	7 6,3	5,9 5,4	t P+												
	2,3 → 26,2 2,3 → 28,6		8 8	8 7,8	6,9 6,4	5,8 t	8 8	8 7,6	7,1 6,4	t P+														
	2,3 → 26,7 2,3 → 29,2		8 8	8 7,9	7,1 t	8 8	8 7,8	t P+	$W_{\text{max}} = W_{\text{min}} - 0,12 \text{ t max.}$															
	2,3 → 25 2,3 → 25		8 8	8 8	t	8 8	8 8	t P+																

Poids de flèche & lest de contre-flèche / Auslegergewicht & Gegenauslegerballast / Jib weight & counter-jib ballast / Peso de flecha y lastre de contra-flecha / Peso del braccio & zavorra di contro-braccio / Peso da lança & lastro da contra-lança
 Вес стрелы и балласт контр-стрелы

	(kg) - 33 LVF (+/- 5%)					(kg)
				3600 kg	1100 kg	
65 m	10840	10630	10925	4	4	18800
60 m	10640	10430	10725	4	4	18800
55 m	10320	10140	10410	4	4	18800
50 m	10020	9840	10110	4	4	18800
45 m	9670	9490	9760	4	3	17700
40 m	9280	9100	9370	4	2	16600
35 m	8800	8620	8890	4	1	15500
30 m	8295	8115	8385	4	0	14400
25 m	7795	7615	7885	3	2	13000

CAU - 3600 kg

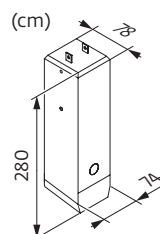



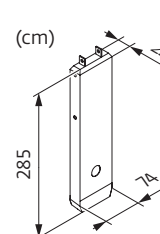

CAV - 1100 kg











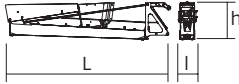
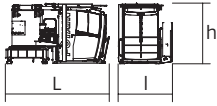



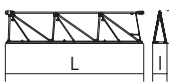
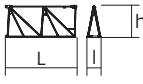
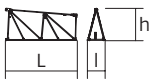

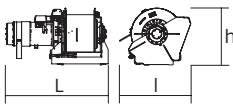
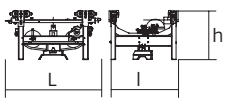

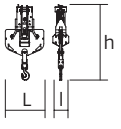

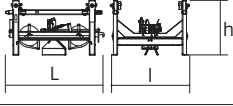

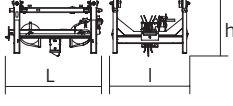

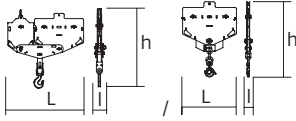
Encombrement et poids / Abmessungen und Gewicht / Dimensions and weight / Dimensiones y peso / Ingombro e peso
dimensões e pesos / габаритные размеры и вес

Partie tournante / Drehender Kranteil / Slewing crane part / Parte giratoria

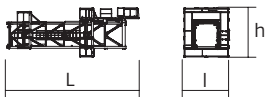
Parte rotante / Parte rotativa / Поворотная часть :  65 m -  -  -  33 LVF

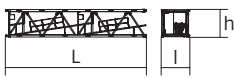
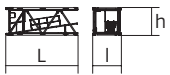
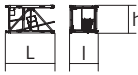
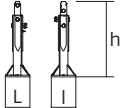
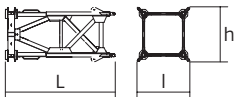

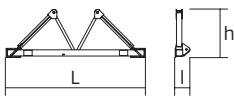
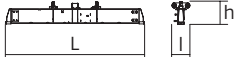
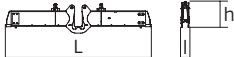
Partie tournante / Drehender Kranteil / Slewing crane part Parte giratoria / Parte rotante / Parte rotativa Поворотная часть		L (m)	l (m)	h (m)	kg (+/- 5%)	
Contre-flèche / Gegenausleger Counter-jib / Contra-flecha Controbraccio / Contra-lança Контр-стрела		11,18	1,53	2,53	5940	
Pivot + cabine / Krankopf + Kabine Towerhead + cab / Pivote + cabina Portaralla + cabina / Pivot + cabina Секция поворотной части + кабина		Ultra View  1,6 m  2 m	4,7 4,76	2,28 2,51	6690 7490	
Elément de flèche / Auslegerelement Jib section / Elemento de flecha Elemento di braccio / Elemento de lança Секция стрелы		① 33 LVF 6 DVF	10,91	2,92	4220	
Elément de flèche / Auslegerelement Jib section / Elemento de flecha Elemento di braccio / Elemento de lança Секция стрелы		②	10,26	1,05	2,42	1885
Elément de flèche / Auslegerelement Jib section / Elemento de flecha Elemento di braccio / Elemento de lança Секция стрелы		③ ④ ⑤ ⑦ ⑧ ⑩	5,23 5,19 5,19 5,18 5,17 5,16	1,05 1,05 1,05 1,05 1,05 1,05	2,36 2,33 2,33 1,92 1,89 1,19	750 600 600 390 350 240
Elément de flèche / Auslegerelement Jib section / Elemento de flecha Elemento di braccio / Elemento de lança Секция стрелы		⑥ ⑨	5,19 5,16	1,05 1,05	2,33 1,9	480 300
Elément de flèche / Auslegerelement Jib section / Elemento de flecha Elemento di braccio / Elemento de lança Секция стрелы		⑪	5,09	1,05	1,17	200
Treuil de levage (+ câble) / Hubwerk (+ Seil) Hoisting winch (+ rope) / Mecanismo de elevación (+ cabo) Argano di sollevamento (+ fune) Guincho de elevação (+ cabo) Подъёмная лебёдка (+ канатом)		33 LVF 50 LVF 50 LVF GH	1,36 1,53 1,61	0,82 0,96 1,35	0,75 0,92 1,26	910 1200 1945
Chariot / Laufkatze Trolley / Carrello Carro / Carro-distribuidor Тележка		 8 t	1,8	1,35	0,96	165
Moufle / Hubflasche Pulley block / Aparejo Bozzello / Cadernal Полиспаст		 8 t	1,02	0,42	2	200
Chariot / Laufkatze Trolley / Carrello Carro / Carro-distribuidor Тележка		 8 t	1,64	1,31	0,9	165
Chariot / Laufkatze Trolley / Carrello Carro / Carro-distribuidor Тележка		 8 t  4 t	1,6 1,6	1,31 1,29	0,9 0,9	160 230
Moufle / Hubflasche Pulley block / Aparejo Bozzello / Cadernal Полиспаст		 8 t  4 t	1,65 1,09	0,25 0,16	1,71 1,49	305 315

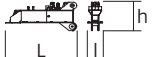
Рулоне / Kranturm / Crane tower Mástil / Torre / Torre Башня крана		L (m)	l (m)	h (m)	kg (+/- 5%)
T 41 T 61		10,85 10,83	3,73 4,14	4,1 4,47	7100 9700
K40/K40-2 K60/K60-2		2,21 2,24	2,1 2,5	2,06 2,46	1330 1930
K 447E KM 447E KM 449E K 649B KM 649E		10,21 10,21 10,21 10,23 10,29	1,62 1,62 1,62 2,07 2,03	1,62 1,62 1,62 2,03 2,03	3390 3215 3830 5290 4850
K 447A KMT 447A K 449A KMT 449A KR 649A KRMT 649A K 649A KMT 649A		5,21 5,21 5,21 5,21 5,23 5,23 5,23 5,23	1,67 1,67 1,67 1,67 2,1 2,1 2,07 2,07	1,62 1,62 1,62 1,62 2,08 2,08 2,03 2,03	1850 1745 2230 2130 3250 3050 2805 2570
K 447C K 649C KMT 649C KRMT 649C		3,45 3,57 3,57 3,57	1,67 2,07 2,07 2,1	1,62 2,03 2,03 2,08	1360 1985 2060 2450
Pieds de scellement / VerankerungsfüÙe Fixing angles / Pie de empotramiento Montante da annegare / Angulos fixadores анкера		0,37 0,65	0,37 0,65	1,14 1,27	135 295
Mât-châssis / Grundmasteinheit Basic mast unit / Tramo-chassis Elemento base / Tramo-chassis Мачта для крепления к шасси		3,63 5,01 10,02	1,96 2,41 2,41	2,08 2,41 2,41	2965 4390 7485
Haubans / Mastabstütungen Struts / Tornapuntas Puntoni / Escoras Растяжка		3,18 4,51 4,51	0,26 0,29 0,33	0,24 0,29 0,33	220 420 515
Sommier / Unterwagenhälfte Half-bearer / Testero Testata / Estrutura base Траверса		5,1 6,7 6,7	0,6 0,7 0,7	1,78 2,31 2,31	1145 1600 1850
Bras de croix / Fundamentkruzträger Cross girder / Brazo en cruz Braccio croce / Braço da cruz Поперечная балка		5,64 6,63	0,82 0,82	1,05 1,05	1590 1830
Bras de croix / Fundamentkruzträger Cross girder / Brazo en cruz Braccio croce / Braço da cruz Поперечная балка		5,64 6,63	0,47 0,47	1,34 1,34	1895 2135
Bras de croix / Fundamentkruzträger Cross girder / Brazo en cruz Braccio croce / Braço da cruz Поперечная балка		7,65	1,17	1,36	3585
1/2 Bras de croix / 1/2 Fundamentkruzträger 1/2 Cross girder / 1/2 Brazo en cruz 1/2 Braccio croce / 1/2 Braço da cruz 1/2 Поперечная балка		3,41	0,7	1,35	1655

Mécanismes / Triebwerke / Mechanisms / Mecanismos / Meccanismi
 Mecanismos / Механизмы

400 V - 50 Hz 480 V - 60 Hz											ch - PS hp	kW		
	33 LVF 20 Optima	m/min	27	36	51	73	14	18	27	37	33	22	290 m	
		t	4	3	2	0,8	8	6	4	1,8				
	50 LVF 20 Optima	m/min	48	62	87	121	25	33	46	61	50	37	363 m	
		t	4	3	2	1,1	8	6	4	2,5				
50 LVF 20 GH Optima	m/min	49	64	88	113	25	32	46	57	50	37	634 m		
		t	4	3	2	1,1	8	6	4	2,6				
	6 DVF 4 Optima	m/min	0 → 80 (8 t)				0 → 100 (2 t)				5,5	4		
	RVF 162 Optima+	tr/min U/min rpm	0 → 0,8								2 x 7,5	2 x 5,5		

	IEC 60204-32		kVA
400 V (+10% -10%) 50 Hz 480 V (+6% -10%) 60 Hz		33 LVF : 45 → 32 kVA 50 LVF / 50 LVF GH : 58 → 38 kVA	

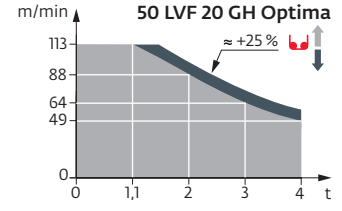
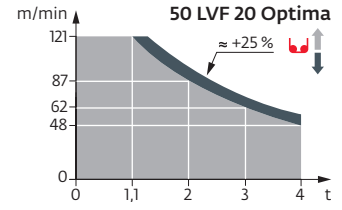
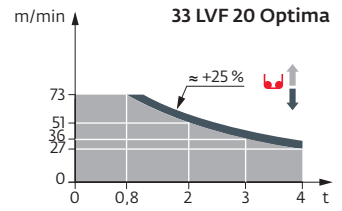

	FR	DE	EN	ES	IT	PT	RU
	Appel de flèche	Auslegerüberhöhung	Jib elevation	Elevación de la flecha	Inclinazione braccio	Desvio da lança	подъем стрелы
	Équipements standards	Standardausrüstungen	Standard equipment	Equipamiento de serie	Equipaggiamento standard	Equipamento de série	Стандартное оборудование
	Équipements optionnels	Sonderausrüstungen	Options	Equipamiento opcional	Equipaggiamento in opzione	Equipamento opcional	Дополнительное оборудование (опция)
	Fonction Potain Plus : Courbes de charges Plus	Funktion Potain Plus: Plus-Lastkurven	Potain Plus function: Plus load curves	Función Potain Plus: Diagrama de cargas Plus	Funzione Potain Plus: Curve di carico Plus	Função Potain Plus: Diagrama de cargas Plus	Функция контроля мощности Potain Plus: Диаграммы грузоподъемности Plus
	Hauteurs sous crochet associées aux courbes de charges Plus	Hakenhöhen mit Plus-Lastkurven	Hook heights with Plus load curves	Altura bajo gancho, usando el diagrama de cargas Plus	Altezze sotto ganccio con curve di carico Plus	Altura livre, utilizando o diagrama de cargas Plus	Высота под крюком для диаграмм грузоподъемности Plus
	Réactions en service	Reaktionskräfte in Betrieb	Reactions in service	Reacciones en servicio	Reazioni in servizio	Reacções em serviço	Реакция при работе
	Réactions hors service	Reaktionskräfte außer Betrieb	Reactions out of service	Reacciones fuera de servicio	Reazioni fuori servizio	Reacções fora de serviço	Реакция в покое
	Poids total du lest	Ballast-Gesamtgewicht	Total ballast weight	Peso total del lastre	Peso totale della zavorra	Peso total do lastro	Общий вес балласта
	Cadre d'ancrage serré	Fester Verankerungsrahmen	Tightened anchorage frame	Marco de anclaje de apriete	Quadro di ancoraggio stretto	Quadro de amarração apertado	Прикрепленная анкерная рама
	Cadre d'ancrage desserré	Loser Verankerungsrahmen	Loosened anchorage frame	Marco de anclaje de desapriete	Quadro di ancoraggio allentato	Quadro de amarração solto	Отсоединенная анкерная рама
	Poids de flèche	Auslegergewicht	Jib weight	Peso de flecha	Peso del braccio	Peso da lança	вес стрелы
	Camion 13,4 m	Lkw 13,4 m	Lorry 13,4 m	Camión 13,4 m	Camion 13,4 m	Camião 13,4 m	Ррузовой автомобиль 13,4 м
	Conteneur High Cube 40', et/ou Flat Rack 20'	Container High Cube 40', und/oder Flat Rack 20'	Container High Cube 40', and/or Flat Rack 20'	Contenedor High Cube 40', y/o Flat Rack 20'	Container High Cube 40', e/o Flat Rack 20'	Contentor High Cube 40', e/ou Flat Rack 20'	40-футовый контейнер повышенной вместимости High Cube, и/или 20-футовая открытая платформа Flat Rack
	Levage	Heben	Hoisting	Elevación	Sollevamento	Elevação	Подъем
	Distribution	Katzfahren	Trolleying	Distribución	Ditribuzione	Distribuição	Перемещение по стреле
	Orientation	Schwenken	Slewing	Orientación	Rotazione	Rotação	Поворот
	Translation	Kranfahren	Travelling	Traslación	Traslazione	Translação	Перемещение крана
	Puissance requise	Erforderliche Leistung	Required power	Potencia Necesaria	Potenza richiesta	Potência Necessária	Потребляемая мощность
	Fonction Power Control : vitesses treuils adaptées à la puissance disponible	Funktion Power Control: Geschwindigkeiten der Triebwerke werden an die verfügbare Leistung angepasst	Power Control Function: winch speeds adapted to the available power	Función Power Control: marchas de los cabrestantes adaptadas a la potencia disponible	Funzione Power Control: velocità degli argani adattate alla potenza disponibile	Função Power Control: velocidades de guincho adaptadas à potência disponível	Функция контроля мощности Power Control: регулировка скорости лебедок в зависимости от доступной мощности
	Nous consulter	Auf Anfrage	Consult us	Consultarnos	Consultateci	Consultar-nos	Проконсультируйтесь у нас
	Document commercial non contractuel. Pour toute information technique se référer à la notice correspondante.	Unverbindliches Vertriebsdokument. Für technische Informationen, siehe die entsprechenden Anweisungen.	This commercial document is not legally binding. For any technical information, please refer to the corresponding instructions.	Documento comercial no contractual. Para cualquier información técnica, ver la noticia correspondiente.	Documento commerciale non vincolante, per tutte le informazioni tecniche fare riferimento al catalogo istruzioni.	Documento comercial não contractual. Para qualquer informação técnica complementar consultar as respectivas instruções.	Этот коммерческий документ не является юридически обязательным. Для получения технической информации, см. соответствующие инструкции.

